

# MEDICAL EDUCATION

Simulation | Skill Training | Anatomy

Find all products online at [3bscientific.com](http://3bscientific.com)

# DEAR VALUED CUSTOMER,



**Todd A. Murray | CEO**

Our mission at 3B Scientific is to “Advance Medical Education...” and as I prepared to write my annual message to you I have been reflecting on our work at the company and the critical role our customers play to help us develop new products and re-energize existing products through thoughtful Innovation. Innovation must be at the core of everything we do at 3B Scientific in product development. In order to help educators globally we must continue to innovate so that you, our customers, can push the boundaries and advance the possibilities in your training locations for your students. In the last couple years we have added many new simulation products to our catalog and upgraded our anatomy line with free software in order to provide you with new choices in this rapidly evolving marketplace. Without the close relationships we enjoy with so many of you, innovation would not be possible.

Closely related to our own product innovation, we work very diligently to understand the trends in the market in order to identify partner’s products to include in our catalog. While we have solutions from many manufacturers because you have told us it is critically important, we work to identify emerging innovative solutions to offer you – several of which are included in this edition. In July 2019, 3B Scientific acquired Cardionics enhancing our range of products for auscultation training. This year 3B Scientific announced that it is joining forces with iSimulate Pty. Ltd. (“iSimulate”), a leader in clinical education technology offering smart and cost effective medical simulation solutions.

We are really excited to have our sister companies with over 50 years of experience in simulation joining our team. Our role has always been to be your “one stop shop” for medical education products and innovation both with our own and other manufactures products will continue to be at the heart of what we deliver to you each year.

A final comment about Innovation – I refer to page 174 of the catalog to introduce you to 3B SMART ANATOMY. This Innovation is really exciting as it allows us to deliver Anatomical Models with access to software training material and coursework through our agreement with 3D4Medical. We have enhanced our anatomy models to help advance the level of training delivered on anatomy education. Please take a look and let’s discuss how this new innovation can help advance training success for students all over the globe.

We will be focused on continued Innovation at our company during the next months and years, so if you have an idea you would like to discuss please let us know.

Sincerely,

A handwritten signature in black ink that reads "Todd A. Murray". The signature is fluid and cursive, matching the professional appearance of the man in the portrait above.

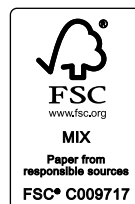



# NEW! AUSCULTATION SIMULATION

The Innovative and holistic approach to auscultation in clinical education with a wide range of products, which are easy to set up whether in a classroom, simulation laboratories, or for online lessons.



**SAM II<sup>®</sup>, the Student Auscultation Manikin M-1020095**

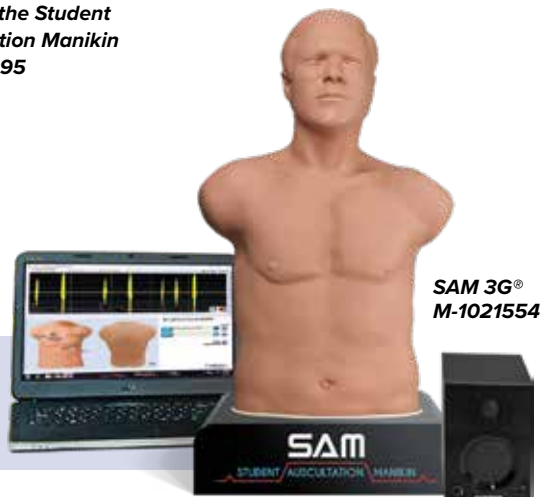

**SAM 3G<sup>®</sup> M-1021554**



Find out more on page 151  
and at [3bscientific.com](http://3bscientific.com)



# 6

## NEW PRODUCTS

Hemorrhage Control Arm Trainer P102	6
BASICBilly+	8
CompuFlo® Epidural trainer	10
Episiotomy Suture Training Module for Birthing Simulator P96	11
Bowel Care Trainer P16	12
NENASim HPS Xtreme	14
REALITi by iSimulate	15
ADAM-X Human Patient Simulator	16



# 20

## MEDICAL SIMULATION

TCCC Training Manikins	22
Tactical Medical Care	26
Advanced Trauma Life Support Rescue	28
Moulage & Wound Simulation	36
Advanced Life Support	38
Adult	40
Child	40
Infant	42
Basic Life Support (BLS)	44
Adult	52
Pediatric	52
Airway Management	62
Adult	66
Child	66
Obstetrics	72
Gynecology	76
Prostate & Rectal Examination	94
Patient Care	100
Adult	102
Child & Infant	111
Wound Care & Bandaging	114
Catheterization	116
Central Line- & Portmanagement	119
Suturing	120
Blood Pressure	122
Clinical Skills   Child	124
Injection Technique	130
Epidural & Spinal Injection	130
I.V. Injection	132
I.M. Injection	136
Venipuncture	139
Image Guided Injection	140
Ultrasound	142
Laparoscopy	144
Auscultation	150
Transesophageal Echocardiography (TEE)	156
iSimulate	158
Ear & Eye Examination	160
Virtual Reality Simulators	164

# 166

## SECTRA EDUCATION PORTAL, TABLE & BOARD

# CONTENT



# 170

## HUMAN ANATOMY

Human Anatomy	170
Complete Anatomy	172
3B SMART ANATOMY	174
Skeleton Models	176
Individual Bone Models	184
Hand & Foot Models	188
Joint Models	192
Vertebrae Models	196
3B BONElike™	198
Spinal Column Models	200
Pelvis & Pelvic Skeleton Models	206
Skull Models	210
Musculature Models	216
Torso Models	222
Skin Models	230
Head & Brain Models	232
Nervous System Models	240
Eye Models	242
Ear, Nose & Throat Models	246
Dentition Models	250
Heart Models	254
Lung Models	260
Digestive & Urinary System Models	262
3B SMART ANATOMY Sets	268

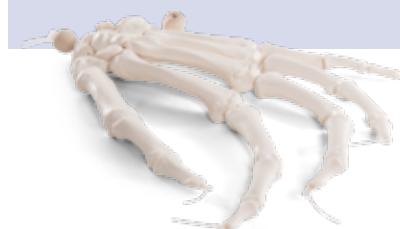



# 276

## 3B ORTHObones

3B ORTHObones Standard	277
3B ORTHObones Premium	278
3B Biomechanical Test Blocks	279



# 280

## HEALTH EDUCATION

Women's Health	281
Contraceptive Education	282
Pregnancy & Birth	284
Parent Education	287
Men's Health	288
Nutrition	290
Healthy Lifestyle	292
Diabetes	294
Drugs & Substance Abuse	296



# 298

## MEDICAL POSTERS



# NEW!

## HEMORRHAGE CONTROL ARM TRAINER P102



Improve pre-hospital patient care training with instructional and hands-on training of **hemorrhage control with wound packing and tourniquet application**. This simulator is especially suitable for Tactical Combat Casualty Care (TCCC) and Civilian Casualty Care training.

The affordable Hemorrhage Control Arm Trainer P102 by 3B Scientific is the perfect solution for **realistic training of bleeding control and management of traumatic injuries** on the arm. Trainees will gain confidence in managing difficult bleeding using tourniquets and wound packing.

*The arm is equipped with three different wound patterns:*



**Deep laceration or stab wound (5 cm)**



**Large caliber gunshot wound through and through (GSW)**



**Junctional wound in the shoulder area**

Instructor controlled bleeding: the bleeding of each wound is controlled with a manual blood pump system simulating venous or arterial pulsatile blood hemorrhage.

The trainer functions as a stand-alone simulator but can also be worn by a volunteer for added realism and in field training using the carrying strap of the bag. The bleeding can be simulated realistically including direct feedback (stop of bleeding) when the trainee successfully manages the hemorrhage.





## ➤ TRAINER FOR HEMORRHAGE CONTROL ON UPPER EXTREMITY WITH REALISTIC WOUND AND BLEEDING SIMULATION.

### Train the following hemorrhage control procedures:

- Tourniquet application
- Wound packing, including junctional wound
- XSTAT® (hemostatic device) application

### Technical features of the Hemorrhage Control Arm Trainer P102:

- The trainer simulates a full arm of an adult male with a very realistic outer anatomy
- The skin is made of high quality SKINlike™ sturdy silicone to simulate human skin and tissue haptics
- Features bony landmarks and palpable vessel damaged in the GSW
- Direct feedback: the bleeding will stop (mechanical occlusion of blood vessels) when tourniquet has been correctly applied (placement and closing)
- The application of the tourniquet can be made "high and tight" or 5-8 cm (2"-3") above the wound
- Each wound can be hidden with a dedicated cover to offer modular injury scenarios
- Each wound bleeds independently
- Designed for field use: sturdy construction, requires no batteries or external power
- Easy to clean and to transport in carrying bag (included)
- Realistic low-cost simulator for repetitive training



### Bleeding system:

- Secure blood reservoir (2 liters) with manual blood pump system simulating venous or arterial pulsatile blood hemorrhage
- No back flow of the blood to the reservoir during wound packing
- Contains 250 ml of artificial blood concentrate for the preparation of 2 liters of blood

### Delivery content:

- Trauma Arm with 3 different traumatic wounds
- 3 wound covers
- Manual blood pump system
- Carrying bag
- Trauma Arm wearable belt
- Blood reservoir for 2 liters
- Concentrate of artificial blood 250 ml

### Dimensions and weight:

93 cm, 3 kg

M-1022652

# NEW!

## BASICBILLY+

➤ THE ECONOMICAL AND RELIABLE CPR TRAINING MANIKIN NOW COMES WITH DIRECT FEEDBACK!



Now smarter with CPR Feedback Apps



The new **BASICBilly+** manikins come with a **direct feedback Upgrade kit** for both students and instructors that enables performance monitoring, analyses and debriefing via **mobile apps powered by heartisense®**. The manikin connects with the app using a strong and reliable **Bluetooth connection** – no need to set up a wireless network. The Instructor App provides a **detailed performance review of up to 6 manikins at a time** while the Student App enables trainees to directly see and monitor their CPR performance.

### Training Manikin Features:

- Made of easy to clean durable, latex free material
- Hygienic to use with low priced and easy to change disposable airways
- Realistic anatomical landmarks to learn correct hand position for chest compression
- Mouth-to-mouth, mouth-to-nose or BVM resuscitation can be practiced
- Offers head-tilt functionality to open the airway or simulate obstructed airway
- Visible chest rise when the lungs are ventilated
- Force to be applied during chest compression have been carefully studied to offer a realistic training
- Manikin available in two skin tones



**BASICBilly+ M-8000951**  
Lighter skin tone, includes training manikin and Upgrade kit\*



**BASICBilly+ M-8000953**  
Darker skin tone, includes training manikin and Upgrade kit\*





**Intuitive Student Feedback App monitors and analyses performance improvement**

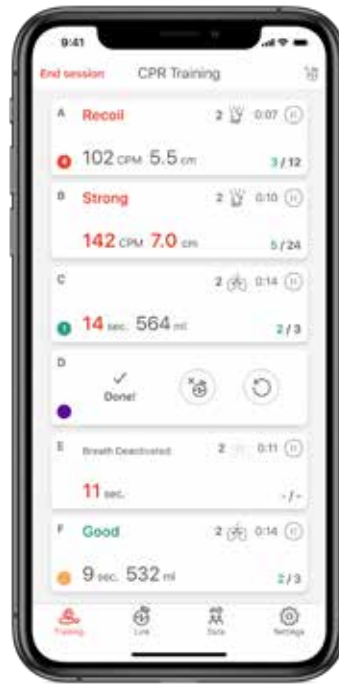

**Instructor App to monitor up to 6 students at a time**



**Student's results can be saved and offer complete debriefing functionality**

**CPR App Features (with Upgrade kit):**

- Direct (real-time) and summative CPR feedback for students
- Offers overall scoring and point of improvement during CPR
- Instructor view can monitor up to 6 manikins at a time
- Instructor can use CPR analysis for detailed debriefing
- Easily switch from conventional CPR training to “compression only” CPR settings
- Export or share students result/certificate as a PDF file
- Save student results for review
- Student and Instructor Apps run both on iOS and Android™ mobile devices
- Both Apps are tablet and smartphone compatible and free to download



**BASICBilly+ CPR Feedback:**

- + Compression depth
- + Compression rate
- + Chest complete release (recoil)
- + Appropriate ventilation volume
- + Hands-off time

**➤ NEW BASICBILLY+ UPGRADE KIT**

**Already own a BASICBilly manikin?**

Buy the Upgrade-kit only to equip your manikin with the AHA required direct feedback functionalities. The hardware of the Upgrade-kit for all BASICBilly Basic Life Support (BLS) manikins is easy to install and the apps are available for download in your app store.

**Delivery content of the BASICBilly+ Upgrade kit:**

- Add-on kit with ventilation sensor attached\*
- Lung bag with ventilation sensor holder
- Color ID stickers
- Installation guide

**M-1022626**

\*The BASICBilly+ Upgrade kit requires 2 “AA” batteries which are not included. The mobile devices to use the apps are not included in the delivery scope.



**STARTING ON PAGE 52 YOU CAN FIND MORE BLS MANIKINS**

# NEW!

## COMPUFLO® EPIDURAL TRAINER

A Leap Forward in Anesthesia Training! Having to rely on subjective factors to identify entry to the epidural space makes insertion a difficult skill to master for trainees. 40-60 attempts may be necessary to reach an adequate success rate. The CompuFlo® Epidural Trainer's real time measurements combined with the extremely realistic haptic feedback from 3B Scientific's P61 Injection Trainer help reduce the number of necessary attempts.



**M-1017891 Epidural and Spinal Injection Trainer P61**

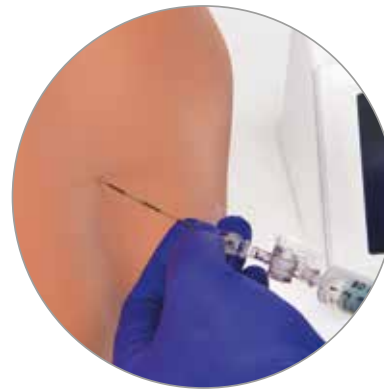

**Injection needle enters epidural space**



**M-1022442 CompuFlo® Epidural Trainer**

### **About the CompuFlo® Trainer:**

The CompuFlo® Epidural Trainer features Dynamic Pressure Sensing® (DPS) technology that detects tissue changes that are imperceptible by touch. This intelligence allows the trainee to objectively identify location and differentiate between true and false loss of resistance.

### **Main features & functions:**

- Provides objective intelligence to shorten the learning curve
- Builds confidence by reducing the number of attempts
- Empowers instructors to empirically monitor needle movement
- Generates procedure documentation to enhance skill development
- Consistently distinguishes between a false and true loss of resistance

**CompuFlo® Epidural Trainer M-1022442**

### **Consumables:**

**CompuFlo® Disposable Kit M-1022443**



### **Perfect Combination: CompuFlo® and Epidural & Spinal Injection Trainer:**

- + Practice with the reliable Dynamic Pressure Sensing® Technology
- + Bring your injection skills to perfection
- + Hands-on practice combined with smart feedback technology
- + About 100 injections per Epidural Training Insert
- + Replacement kits available

**M-8000949**



**FOR MORE INFORMATION ABOUT EPIDURAL AND SPINAL INJECTION PLEASE SEE PAGE 130**

# NEW!

## EPISIOTOMY SUTURE TRAINING MODULE FOR BIRTHING SIMULATOR P96

The Episiotomy Suture Training Module will upgrade your 3B Scientific® Birthing Simulator PRO or BASIC with realistic postpartum episiotomy suturing and repair skills training features. The soft skin will support real sutures and will enable the trainee to gain experience in instrument handling as well as suture techniques and tying knots.



**Use this module to practice and teach medical care of the following birth injuries:**

- Mediolateral left
- Medial or midline
- And much more thanks to the uncut insert

**Features:**

- Compatible with 3B Scientific® Birthing Simulator PRO and BASIC
- Easy installation of the different inserts and of the module in the 3B Scientific Birthing Simulator
- Two inserts feature medial episiotomy and mediolateral episiotomy with tears in the labia minora
- One insert is uncut and enables the instructor or trainee to choose the episiotomy location they want to train
- Realistic soft skin
- Supports the use of real suture instruments
- Supports real sutures
- Durable reusable skin
- Made of latex-free material

**Delivery content:**

- 1 module base
- 2 episiotomy suture inserts, pre-cut
- 1 episiotomy suture insert, uncut
- Safety plate with 4 screws  
(for the optional insert in Birthing Simulator PRO/BASIC)

**M-1022212**

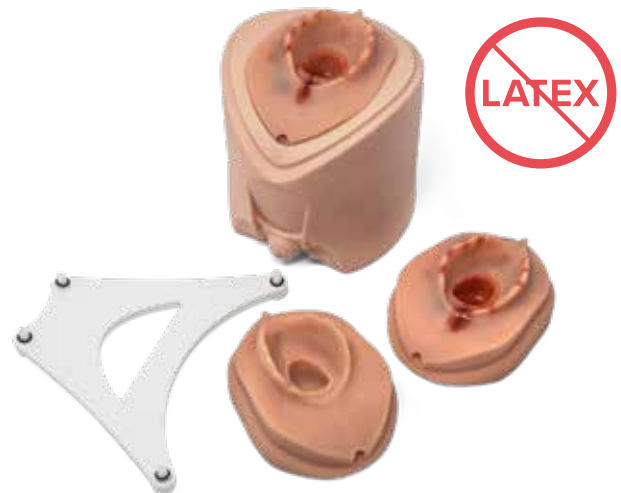

### › EPISIOTOMY SUTURE TRAINER FOR REALISTIC OBSTETRIC SKILL TRAINING

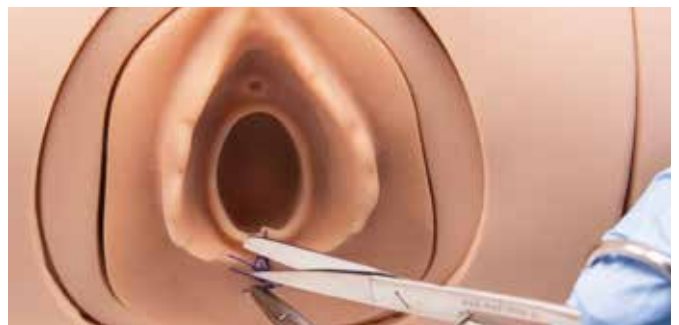

USE THE INSERTS ALONE OR AS AN ADDITION TO BIRTHING SIMULATOR  
SEE PAGE 87 FOR MORE INFORMATION!

# NEW!

## BOWEL CARE TRAINER P16

High quality life-size bowel care trainer for realistic enema and bowel care management and interventions training. Improve the hospital patient care training in order to reduce the risk of complications associated with management of lower bowel dysfunction and ensure patient safety.

The economical Bowel Care Trainer P16 by 3B Scientific is an excellent choice to optimize the skills of students and patient care staff with direct feedback, from the results of the enema administration. The various functions of the simulator allow the trainees to administer different procedures during the training. A secure fluid reception reservoir system makes the portable Bowel Care Trainer leakage free. Even sponge bath practice is possible using the simulated solid and soluble stool. Thanks to quick and easy change of the setting (< 1 min) various techniques can be trained under instructor control and during student practice.



### Train the following bowel care procedures:

- Enema administration: cleansing, oil-retention, return-flow, medicated enemas
- Suppositories administration
- Medication administration
- Digital Rectal Examination (DRE) and Stimulation (DRS)
- Digital Removal of Faeces (DRF)

### Technical features of the Bowel Care Trainer P16:

- This high quality bowel care trainer simulates the buttock of a patient with femoral stumps, anus and bowel in pre-positioned left lateral recumbent position
- The upper buttock is soft and flexible to be most realistic; the trainee has to lift it to gain access to the anus
- Supports the insertion of CH16 to CH40 catheters and balloon rectal tubes
- The different Digital Rectal Inserts are made of SKINlike™ sturdy silicone to simulate human skin and tissue haptic during DRE and DRS
- Anus stays close and remains impenetrable after the removal of the catheter due to the high quality of the insert material

### Secure fluid reception reservoir system:

- Ensures portability, impermeability, security
- Administer standard enema solutions without risk up to a volume of 2 liters
- Fluid can be drained into the reception reservoir or directly into a nearby sink or canister
- Easy to clean
- Optimized design to enable a quick and simple installation for each procedure
- Includes a soft carrying bag and a storage box for the different consumables and inserts



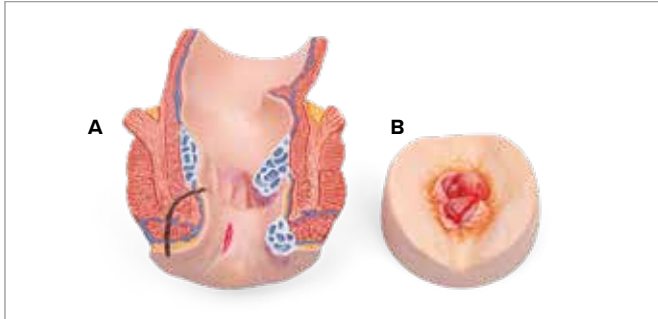

**Contains two 3D (three dimensional) anatomical didactic models of hemorrhoids to facilitate the explanation of complication or contraindication:**

- A: Rectum frontal section with hemorrhoids, anal fissures and fistulae
  - B: External view with swollen anal prolapse and hemorrhoid knots
- The 3D models are attached to the model with magnet so the model can be passed from student to student during class.

**Delivery content:**

- Bowel Care Trainer P16 by 3B Scientific
- Secure fluid reception reservoir
- 1 DRE, 1DRS and 1 DRF insert
- 2 magnetic 3D anatomical models of Hemorrhoids
- Artificial solid stools (Bristol Stool Chart type I)
- Solid (150 g) and soluble (60 g) stool powder, artificial
- Dosage spatula and cup for stool preparation
- Bottle of concentrate blood (250 ml), artificial
- Blood pipette injector
- Talcum powder (100 g), Vaseline
- Plastic storage box for consumables
- Soft carrying bag

**Dimensions and weight:**

3,8 kg; 55 × 35 × 32 cm

**M-1022519**

**Replacements and Consumables:**

**Artificial Soluble Stool Powder (60 g)**

**M-1022521**

**Artificial Solid Stool Powder (1 kg)**

**M-1022522**

**Digital Rectal Inserts Replacements Set**

**M-1022523**

**Digital Removal of Faeces (DRF)**



**Enema Administration**



# NEW!

## NENASim HPS XTREME

The NENASim HPS Xtreme is an advanced wireless scenario-based simulator. It simulates a baby from 0 to 6 months old. To be used for a full range of medical skills, procedures and team training. With its predefined and customizable scenarios NENASim HPS Xtreme gives the needed experience, competence and confidence for medical training.

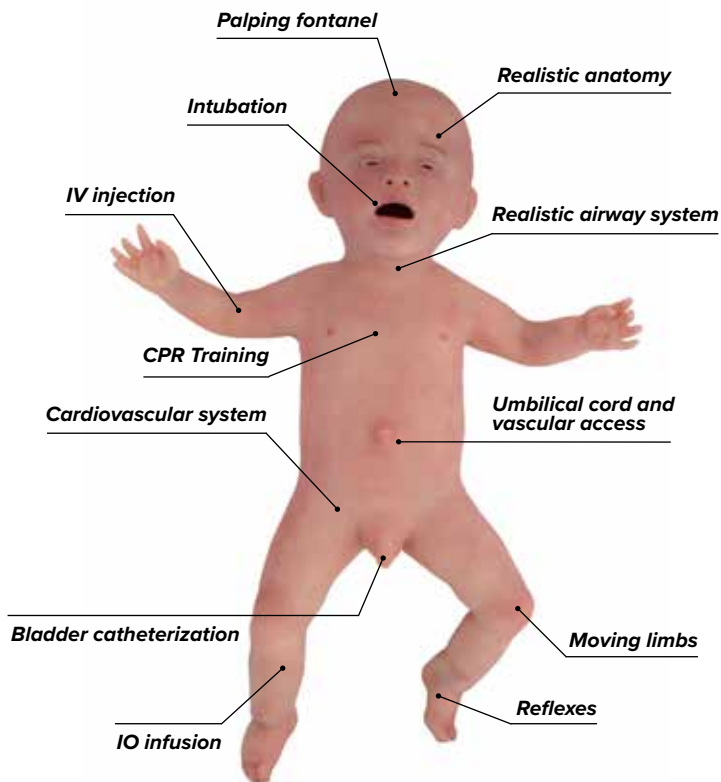

### Software included:

- Tutor, Scenario Editor, Patient monitor, ECG and sound Editor
  - The patient monitor, which accurately replicates the graphs and values as shown on the tutor software, making any adjustments by the tutor directly visible.
  - Tutor software for tracking, commenting and evaluating the full scenario.
  - Scenario Editor for creating and editing your own scenarios. All parameters, responses and sequences can be adjusted within an easy-to-use program
- Additional cameras (up to 3) can be added

**Dark Skin NENASim HPS Xtreme  
M-1022583**

**Light Skin NENASim HPS Xtreme  
M-1022582**

### Features:



**Auscultation of heart, lungs and bowel sounds**



**CPR Application**



**Catheterization**



**Oral Intubation**



**Cyanosis, Jaundice, pale and red**



FOR A COMPLETE OVERVIEW OF OTHER AVAILABLE NENASim MODELS REFER TO PAGES 44-45.



# NEW!

## REALITi BY iSIMULATE



### **REALITi Highly Advanced Patient Simulator**

REALITi is a modular simulation ecosystem incorporating a patient simulator, CPR feedback and video in a single system. Starting with 2 iPad® tablets, REALITi is a highly advanced patient monitor simulator which mimics proprietary monitors and defibrillators. By adding more modules, a complete in-situ simulator with live video streaming, CPR feedback and simulated patient records can be created.

#### **Main Features of REALITi:**

- Mimics real defibrillators and monitors – looks, sounds and functions like the real thing
- Defibrillator screens from Zoll, Corpuls, Philips and many more are included
- Advanced ECG and 12-lead settings
- OSCE & log function
- Ability to build custom scenarios
- REALITi Community
- Unlimited possibilities of waveform combinations (add ectopics, arrhythmias and artifacts to any ECG waveform can be added by the user)
- Realtime feedback with CPR module
- CPR module can be deployed and used in 3 different ways
- Meets AHA requirements
- CPR report for review
- Integrated wireless video with REALITi Camera for detailed debriefing
- REALITi Chart has a complete library of resources to create simulated electronic patient records



**Contact us for more information**

#### **REALITi Engage for iOS - Download the free app to debrief your simulation scenario**

Add REALITi Engage to allow observers to comment, vote and view media during the simulation without disruption.

REALITi Engage allows those observing the simulation to provide their feedback instantly by either tapping one of the preset feedback options or by providing their specific commentary. Feedback is pinned to the simulation timeline for easy review.

REALITi Engage receives all labs and media used within the scenario, giving observers great visibility of the simulation. Available in your App store for iPhone®, iPad®, and iPod® touch.

### **YOUR CUSTOMIZED SIMULATION SOLUTION!**

Please work with our configuration assistance to pick and choose your simulation packages, software features, and hardware.



#### **ALSi Upgrade to REALITi**

iSimulate offers all ALSi customers the cost-effective option to upgrade to REALITi. Keep the features of ALSi, but expand your monitor views with any of the available proprietary screens and have the flexibility to switch to another monitor surface without additional hardware. You will have more options at your disposal. REALITi can be extended at any time with modules such as CPR feedback and Video Recording. With iSimulate you get professional products at a fair price.

**Contact us for more information**

# NEW!

## ADAM-X HUMAN PATIENT SIMULATOR



The high-end human male patient simulators of the ADAM-X series are designed for practicing skills and providing medical assistance in case of emergency.

ADAM-X is available in various degrees of fidelity as ALS, HPS, and HPS PRO manikin versions.

### ADAM-X HPS PRO

ADAM-X HPS PRO simulator is the most realistic high fidelity adult male human patient simulator developed for realistic multidisciplinary team as well as individual patient simulation training.

The simulator is your ideal training solution for a wide range of healthcare professionals, including patient care, emergency medical intervention and resuscitation training for dynamic team training.

- Wireless and tetherless human patient simulator
- Ideal for ALS training
- Excellent for scenario, medical treatment and on-site training
- Connectable to real human patient monitor and anesthesia machine
- Includes simulated patient monitor
- Extremely realistic head and body

**M-1022584**

### ADAM-X Modular Limbs

Available upon request, the different arms and legs can be used for the ADAM-X HPS PRO and ADAM-X ALS.







### ADAM-X ALS

The ADAM-X ALS manikin includes a reproduction of the skeletal and anatomical structure of a human with distinctive characteristics and features. It is humanized and has a very realistic skin. ADAM-X ALS is ideal for ALS training, scenario training and medical treatment training. It is very portable and ideal for on-site training. The ADAM-X ALS manikin can be upgraded with additional features shown below.

**M-1022585**

*Optional upgrades to be added to ADAM-X ALS for additional training:*

#### ADAM-X ALS Upgrade 1

- CPR feedback with software
- IV arm

**M-1022677**

#### ADAM-X ALS Upgrade 2

- CPR feedback with software
- IV arm
- Pulses (neck and arms)
- Auscultation (cardiovascular and pulmonary)

**M-1022675**

#### ADAM-X ALS Upgrade 3

- CPR feedback
- IV arm
- Pulses (neck and arms)
- Blood pressure
- Auscultation (cardiovascular and pulmonary) spontaneous breathing controlled with software

**M-1022676**

➤ PLEASE LOOK AT THE TABLE BELOW TO FIND THE ADAM-X SIMULATOR THAT BEST FITS YOUR REQUIREMENTS.

	ADAM-X HPS PRO M-1022584	ADAM-X HPS M-1021109	ADAM-X ALS M-1022585
Realistic anatomy with distinctive characteristics and features	✓	✓	✓
Durable and suitable for training in any trauma emergency situation	✓	✓	✓
Simulate a wide variety of clinical situations	✓	✓	✓
Work with a real electrocardiogram and defibrillator	✓	✓	-
Wireless technology	✓	✓	-
Unique pharmaceuticals system	✓	✓	-
Scenarios and medical treatment training	✓	✓	-
Includes simulated patient monitor	✓	✓	-
Extremely realistic head and body	✓	-	✓



FOR ADAM-X HPS AND OTHER ADVANCED TRAUMA LIFE SUPPORT MANIKINS SEE PAGE 28.

# STRATEGIC PARTNERSHIPS



## Strategic partnerships to globally advance medical simulation

The international 3B Scientific Group keeps on growing! This year 3B Scientific announced that it is joining forces with iSimulate Pty. Ltd. (“iSimulate”), a leader in clinical education technology offering smart and cost effective medical simulation solutions. “Our 3B Scientific global distribution footprint including fourteen commercial locations is uniquely positioned to further support and accelerate the growth of iSimulate products worldwide,” said Todd Murray, CEO of 3B Scientific. Cardionics, a leading manufacturer of simulators for auscultation skills training, was acquired in 2019.

We all believe that medical educators will increasingly demand more realism and durability in medical simulators and skill trainers. “Our customers can expect continued innovation and collaboration from the 3B Scientific Group, as we focus on the needs of medical education around the globe,” said Lou Oberndorf, founder of METI and chairman of both 3B Scientific and Operative Experience.



**Lou Oberndorf,**  
Chairman

### **About Lou Oberndorf**

Mr. Oberndorf brings more than 18 years of experience in medical technology leadership. He founded Medical Education Technologies Inc. (METI), the first company to deliver high-fidelity patient simulation to healthcare education, now present in more than 2000 institutions worldwide. Prior to that, he served as Vice President

of Marketing and Senior Vice President of Business Development for Loral Corporation. In 2011, he endowed the Lou Oberndorf Lecture on Innovation in Healthcare Simulation at the International Meeting for Simulation in Healthcare (IMSH) and 2015, he received the Pioneer in Healthcare Simulation award from the Society in Healthcare Simulation (SSH).





**Reliable simulators with direct feedback**



**About the 3B Scientific Group**

3B Scientific was founded in 1948 in Hamburg, Germany and has grown to be one of the world's leading manufacturers of Medical and Science Education solutions. The product portfolio covers a complete and comprehensive range of equipment for simulation and skill training, anatomy, healthcare and patient education and is continuously updated with new products and innovations. Represented in over 120 countries worldwide, the brand name 3B Scientific® stands for best quality, best value, and best service. The mission of 3B Scientific is to advance medical and healthcare delivery through the quality, breadth and global reach of relevant educational and simulation products.



**Smart solutions for emergency medical simulation**



**About iSimulate**

iSimulate was founded by Peter McKie and Anthony Lewis in 2011 with the mission of providing effective, reliable and realistic simulation tools. The solutions they developed together have revolutionized healthcare simulation training worldwide by offering smart and cost effective solutions for medical emergency simulation. Learn more about the iSimulate products on pages 15 and 158-159.



**Innovation in medical simulation**



**About Cardionics**

Cardionics was founded by the late Dr. Abe Ravin, M.D., FACC in 1969 and continues to set the pace for auscultation products and services through the development of unique, interactive, and experiential systems that integrate seamlessly into classroom, clinical, and telehealth applications.

The mission of Cardionics is to make the world a better place through life-saving and medical education innovations.



**Realistic "hands-in-the-body" simulation for advanced medical scenario training**



**About Operative Experience**

The mission of Operative Experience is to revolutionize surgical and medical team training. Using medical simulators with unprecedented anatomical and surgical fidelity within a rigorous experiential instructional paradigm, Operative Experience will reduce training costs while increasing training effectiveness and retention. Operative Experience is dedicated to applying this technology throughout the continuum of care, from tactical operations in the field to emergency procedures in the OR.



## MEDICAL SIMULATION

3B Scientific stands for the most life-like medical training products for customers like medical and science universities, technical colleges, teaching hospitals, simulation centers, nursing schools and all teaching areas of allied health. The extensive range of high quality medical simulators, clinical skill trainers and complete skill lab set ups is sure to meet the needs of medical educators around the globe.

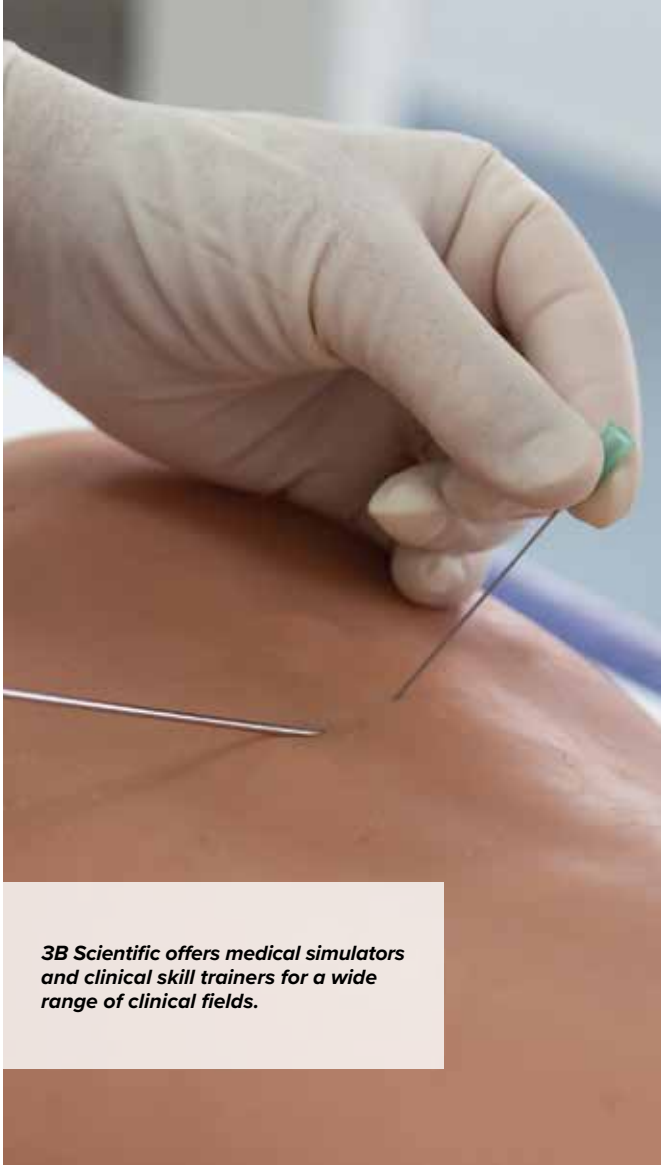

***3B Scientific offers medical simulators and clinical skill trainers for a wide range of clinical fields.***

Through our strong global customer relationships we have learned that medical educators will increasingly demand more realism and durability in our products.

3B Scientific is an expert in plastics and silicones and continues to develop innovative and even more realistic materials and technical solutions to provide you with simulators made of high-quality silicone for a realistic look, feel and texture in addition to a life-like softness.

Our medical simulators and clinical skill trainers are designed to help trainees develop the confidence and skills needed to provide high-quality, comprehensive care to their patients across various specialties.

Following our commitment to meeting your needs for medical education, we offer products that are affordable, versatile and realistic training tools that will enhance the competence and confidence of the health-care professional.

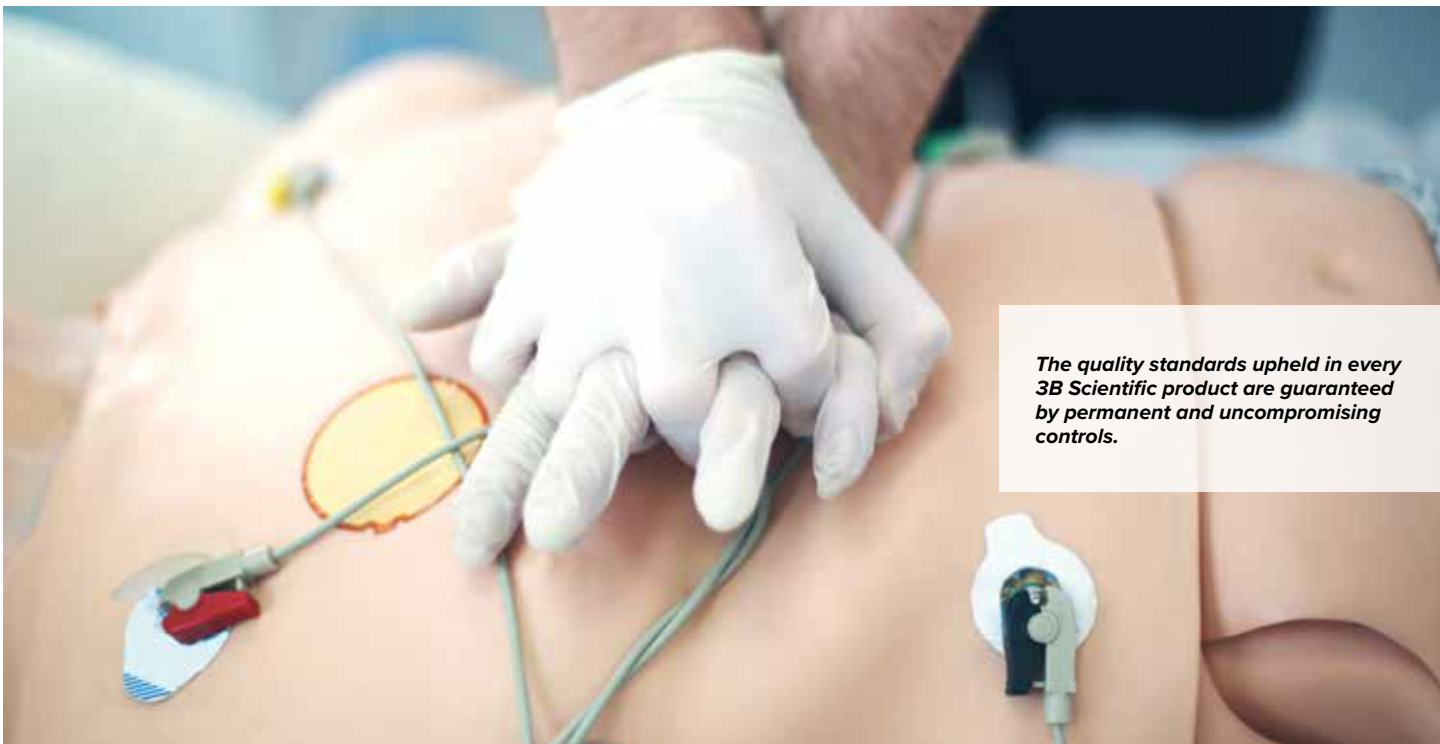

***The quality standards upheld in every 3B Scientific product are guaranteed by permanent and uncompromising controls.***

# TCCC TRAINING MANIKINS



## ▶ A SUPER-REALISTIC POINT OF INJURY CASUALTY CARE SIMULATOR FOR TCCC TRAINING

### Complete simulator with combat wounds to enhance TCCC training

**The TCCS offers military, government forces, medical rescue, and private security a realistic way for combat trauma care training:**

- Traumatic battlefield wounds
- Hemorrhage management
- Airway management
- Trauma management of breathing and circulation

### TCCC training can get rough and this trauma simulator was built to last under the toughest training scenarios:

- Full-body simulator, realistic size and weight (1.93 m and 84 kg) with fully articulating limbs for high threat extraction training
- Simple to operate, fully mobile and remotely controlled for realistic TCCC field training scenarios
- Easy-to-use instructor interface tablet with simulation logs and self-diagnosis
- Remote controlled (up to 48 m): respiratory and heart rate, pneumothorax activation, pulsating bleeding and arterial hemorrhage with 3-liter blood reservoir

### Included standard TCCC training features:



**Emergency, oropharyngeal and nasopharyngeal airway**



**Cricothyrotomy**



**Standard and junctional tourniquet, use any tourniquet for application training**

*Hemorrhage management, 3 l blood reservoir*

*5 different combat wound configurations*

*Fully articulated, 84 kg*

*Extremely realistic material, no hard plastics*

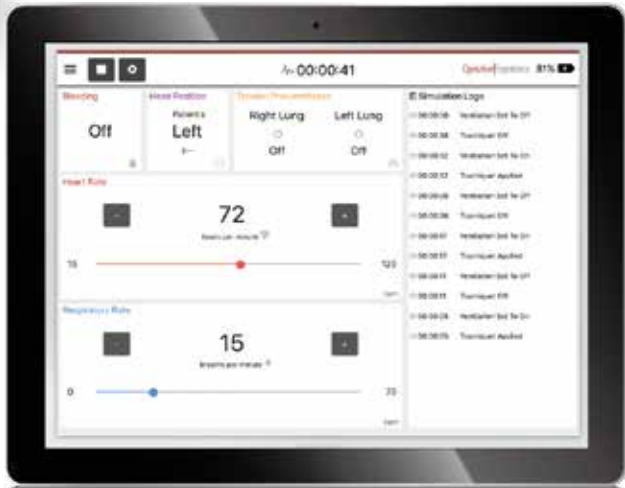

*Remotely controlled for realistic in-the-field scenarios, up to 48 m distance*



*Remote-controlled pulsating bleeding for wound packing*



*Humeral and sternal intrasosseous. Any I.O. device can be used on the system*



*Needle decompression midaxillary and midclavicular*

## ➤ IMPROVING PATIENT CARE UNDER FIRE

The world's only biofidelic emulation technology for super-realistic point of injury casualty care. The Tactical Casualty Care Simulator (TCCS) is a ruggedized simulator for comprehensive TCCC training with wounding patterns that simulate injuries from an IED followed by an ambush. Simple to operate, the TCCS is designed for training in pre-hospital patient care, wound management and hemorrhage

control. The TCCS features arterial hemorrhage, humeral & sternal intraosseous, two-way communication and needle decompression; and is highly ruggedized, water-resistant and fully mobile providing the ability to create realistic and challenging training scenarios in any indoor or outdoor environment.

## ➤ STANDARD TCCC TRAINING FEATURES:

Hemorrhage Management	Airway Management	Breathing and Circulation
Bleeding control via elevation, pressure points and kneedropping method	Insertion of nasal & oral pharyngeal airways	Bilateral and independent chest excursion
Apply tourniquets to control massive hemorrhage (CAT, junctional)	Advanced foreign body removal	Midclavicular and midaxillary needle decompression for tension pneumothorax
Effective drop knee technique	Suction of the airway	Humeral and sternal intraosseous infusion
Multiple and independent bleeding sites	Perform intubation (King LT and I-Gel)	Respiratory distress
Through and through wounds	External ventilation (Bag Valve Mask)	Carotid and radial pulses
Wound packing for severely bleeding wounds	Cricothyrotomy	–

### The Tactical Casualty Care Simulators are delivered with:

- Two-way communication headset, range up to 91 m
- Instructor control interface tablet, case, software and license
- Rugged carry case
- 3.8 l concentrated, simulated blood (antimicrobial, antifungal, antifreeze): 121 l of blood
- 2 rechargeable batteries 18V 12Ah lithium-ion (electrical input 110V)



Prepare all combatants to

- + care for life-threatening battle-field wounds
- + control massive external hemorrhage
- + care for casualties while under fire
- + extricate casualties and move to relative safety







## ➤ CHOOSE YOUR WOUND CONFIGURATION:

The training manikin for Tactical Combat Casualty Care is available with the following specific wound configurations in addition to the standard features (hemorrhage management, airway management, and advanced trauma life support).



**TCCS 1:**  
Gunshot Wound  
Management

**TCCS 2:**  
Major Vascular Injury

**TCCS 3:**  
Traumatic Amputation  
Injuries

**TCCS 4:**  
Multiple Traumatic  
Gunshot Wound and  
Amputation Injuries

**TCCS 5:**  
Abdominal Wounds  
with Evisceration

**M-1021380**

Gunshot wound to the face  
causing hemic drowning

Gunshot wound to  
left upper arm

Fragment wounds to the  
left chest

–

**M-1021381**

Shrapnel injury to neck caus-  
ing major vascular injury

Oblique through-and-through  
gunshot wound to right groin  
above tourniquet line

Gunshot wound to left thigh

Open tibia/ fibula fracture

**M-1021382**

Traumatic amputations above  
left elbow, above left knee,  
and at upper right thigh above  
tourniquet line

Burn, blast and fragment  
wounds on left side of body

–

–

**M-1021383**

Traumatic amputation  
above the left elbow  
and the left knee

Fragmentation wounds  
to left side of the body

Sucking chest wound  
(i.e. open pneumothorax)

Burns to the left  
side of the face

**M-1021384**

Open abdominal wound  
with evisceration

Traumatic amputation  
above right wrist

Deep avulsion of the pos-  
terior proximal right thigh

–

# TACTICAL MEDICAL CARE



## Tactical Hemorrhage Control Trainer

Life-like, full body training manikin for Hemorrhage Control. Ideal for training emergency personnel and first responder units in Tactical Emergency Casualty Care. Ruggedized body made from one piece, no hard plastics.

- Control life threatening external hemorrhage and extremity hemorrhage
- Presents multiple injuries involving gunshot wounds, stab wounds and crushing injuries
- 3-liter blood reservoir

## The Tactical Hemorrhage Control Trainer is delivered with:

- 3,8 l concentrated artificial blood (antimicrobial antifungal, antifreeze)
  - 2 rechargeable batteries and chargers
  - 2 wireless remote control
  - 10 I.O. humeral replacement parts
  - 10 I.O. sternal replacement parts
  - 2 Neck Band replacement parts
  - Rugged carry case
- M-1021644**

Pulsatile wireless control distance 20 m

Tourniquet CAT, tourniquet junctional application

Sternal / Humeral Intraosseous

Cricothyrotomy

Full body articulated of 82 kg and 1.93 m water resistant

Bleeding management via elevation, pressure points and kneedropping

Chest Seal application

NPA / OPA insertion



➤ PLEASE LOOK AT THE TABLE BELOW TO FIND THE TACTICAL TRAINER THAT BEST FITS YOUR REQUIREMENTS

	Tactical Hemorrhage Control Trainer - THCT	Tactical Casualty Control Simulator - TCCS
<b>Tactical protocols</b>		
Combat trauma injuries, amputation and gunshot wounds for hemorrhage management training and care under fire	Depends on the wound configuration chosen	Depends on the wound configuration chosen
Tactical extrication and evacuation	✓	✓
Airway stabilization	✓	✓
<b>System</b>		
Simulator remotely operated	Infra-red remote controller	Wi-Fi connection with iPad®
Operation of the simulator through the OEI App	-	✓
Battery autonomy	2-4 hours	4-6 hours
Two way communication	No	91 m
Wireless control distance	20 m	48 m
Available in different wound configurations	✓	✓
Realistic and life-like around 190 cm and 85 kg	✓	✓
Anatomically-accurate sturdy soft tissue	✓	✓
Ruggedized and fully articulating limbs for high threat extrication training	✓	✓
Resistant for outdoor climate and exercise under rain	✓	✓
<b>Hemorrhage Management</b>		
Arterial pulsatile bleeding	✓	✓
Bleeding control via elevation and pressure point (knee drop)	✓	✓
Wound packing	✓	✓
Multiple tourniquets application	✓	✓
Tourniquet CAT or Junctional tourniquet	✓	✓
<b>Circulation</b>		
Heart rate frequency control	-	✓
Carotid and radial pulses	-	✓
Humeral and sternal intraosseous access	✓	✓
<b>Airway Management</b>		
Spontaneous breathing with chest elevation	-	✓
Ventilation rate frequency control	-	✓
Pneumothorax (unilateral or bilateral) simulation	-	✓
Oro. and Nasopharyngeal airway (OPA and NPA) insertion	✓	✓
Intubation with I-gel® capable (supraglottic airway)	✓	✓
Intubation with King-LT® capable (laryngeal tube)	✓	✓
Cricothyrotomy	✓	✓
Needle decompression training	✓	✓ (with feedback)

# ADVANCED TRAUMA LIFE SUPPORT

## ADAM-X HPS

ADAM-X is a high-end human patient simulator designed for practicing skills and providing medical assistance in case of emergency. ADAM-X is suitable for training in any trauma emergency situation in any environment, and it is ideal for military and civilian trauma emergency training.

ADAM-X has a wireless system, a fully functional wireless computer allows the instructor to monitor and make adjustments in the course of the training. This human patient simulator has distinctive and unique characteristics and features, making the training more realistic.

## Realistic Anatomy

ADAM-X is a reproduction of a skeletal and anatomical structure of a human with distinctive characteristics and features. It is human-sized and has a very realistic skin. ADAM-X has automatic blinking depending on physiological status, as well as a physiological reaction of the pupils to light and to touch.

## Training

The ADAM-X is ideal for ALS training, scenario training and medical treatment training. Because the ADAM-X is completely wireless and tetherless, and has realistic human proportions, it is very portable and ideal for on-site training.

## Sounds

ADAM-X has a wide variety of sounds. Auscultation is possible with 8 points of breath sounds, 5 points of heart sounds and 14 points of lung sounds on the front of the mannequin, with the possibility of an independent set of options of the sounds in 4 areas. There is also the possibility of auscultation on the back of the mannequin. Breath sounds are independent and are related to ventilation of each lung.

## Cardiovascular System

The ADAM-X has a bilaterally palpable pulse on the carotid artery, the femoral artery, the radial artery, the dorsal artery of the foot, the popliteal artery and the posterior tibialis.

## Pulmonology

ADAM-X has a very realistic respiratory tract. It has fully independent right and left lungs, and ventilation of the lung automatically leads to the appropriate sounds of breathing, chest excursion and pulmonary gas exchange. The occurrence of apnea or hypoventilation, along with the low fraction of oxygen in the inspired gas mixture, lead to corresponding physiological changes: the hypercapnia, the hypoxemia, the decrease of the SpO<sub>2</sub> and the tachycardia. Ventilation of the lungs at a positive pressure or spontaneous ventilation restoration returns ADAM-X to the breath with an appropriate amount of respiratory rate.

**M-1021109**



## Also available:

ADAM-X HPS Pro	M-1022584
ADAM-X ALS	M-1022585

## Consumables and replacement parts:

Replaceable Neck	M-1021617
Cricothyroid Membrane	M-1021618
Replaceable Knee	M-1021619



## Product features

- + Works with a real electrocardiogram and defibrillator
- + Possibility to connect a real human patient monitor and a real anesthesia machine
- + Train a normal course of anesthesia as well as general complications
- + Unique pharmaceuticals system: the ADAM-X recognizes not only the administered drug, but also the received dose, a change of the vital parameters occurs correspondingly
- + Create more scenarios with the scenario editor
- + Realistic feedback force

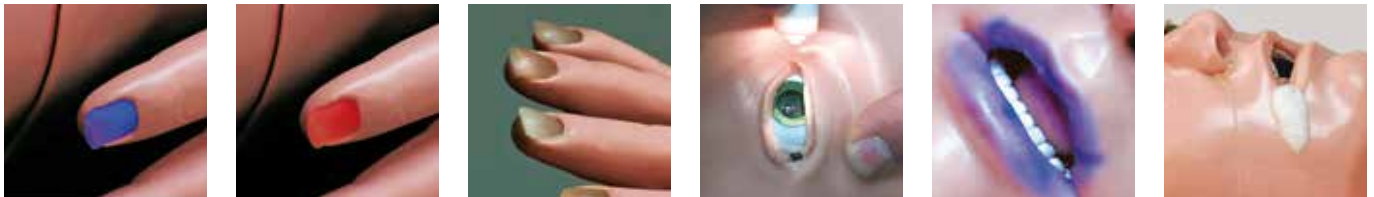

### SMART STAT Complete with iPad®

This high end patient simulator takes ALS training into the student's environment. Instructors can evaluate student knowledge, skill levels, and critical thinking abilities by utilizing the applications via the included iPad®: the new interface makes these tasks a lot easier. Responsive controls and dynamic scenarios are easy to manage with PDF formatted reports.

This simulator can function in the lab and in the field for ascertaining diagnostic ability. Student performance records can be transferred to a computer, and chronological scenario event logs can be printed. SMART STAT has an on-board air compressor, includes a free app on the iTunes Store®, and storage for students' performances.

### SMART STAT Complete comes with:

- Amputated bleeding leg
- Intraosseous leg
- Sim vitals 5-line hospital monitor (simply display all vital parameters on the iPad® or an external monitor)

Also comes with an iPad®, USB cable, blood pressure cuff, hard carry case, shorts, and a supply of replacement parts: 10 neck skins, 4 IM injection pads, 6 pneumothorax pads, 3 sets of teeth, and IV vein kit. 140 x 71 x 28 cm; 88 kg

**M-1018473**

### SMART STAT Basic with iPad®

The basic version of SMART STAT comes without the Sim vitals 5-line hospital monitor, amputated bleeding leg, and I/O leg.

140 x 71 x 28 cm; 61 kg

**M-1018472**



### Key training features

- + Advanced airway management
- + ECG
- + Pacing emergent lung sounds (anterior and posterior)
- + Emergent heart sounds
- + BP arm
- + Pulse points
- + Bilateral chest decompression
- + Bilateral chest tube insertion
- + Virtual capnography and oximetry

Consumables and replacement parts	Item No.
Amputated bleeding leg	M-1018590
Intraosseous leg adult	M-1018593
Pneumothorax pads	M-1018571
IV replacement skin	M-1018572
Replacement vein set	M-1018573
Injection site replacement, arm	M-1018574
Injection site replacement, thigh	M-1018575
Cricothyrotomy replacement skin	M-1018570
Battery leg	M-1018576
Battery charger	M-1018577
Amputated arm	M-1018592
I/O leg skin	M-1018566



### Truman Trauma X

The Truman Trauma system offers an anatomically correct simulated human torso designed for practice of several surgical procedures together with the renowned AirSim® head for training the full range of airway management and resuscitation skills. The Truman Trauma also allows the use of replaceable tissue sets that allow each learner a life-like and unique surgical experience.

79 x 45 x 28 cm; 14 kg

**M-1020959**

#### Consumables and replacement parts:

Needle decompression inserts	<b>M-1017611</b>
Overlay neck skin	<b>M-1022394</b>
Economy Torso Insert (Pair)	<b>M-1022445</b>
Lubricant	<b>M-1017615</b>



## Truman Trauma X System

- + Chest tube insertion
- + Needle decompression of tension pneumothorax
- + Cardio pulmonary resuscitation
- + Needle and surgical cricothyroidotomy
- + Airway management skills including OP and NP airway tube insertion, tracheal intubation, bag valve mask techniques, supraglottic airway insertion and ventilation
- + Percutaneous tracheostomy
- + Identification of tracheal deviation and jugular vein distension



### PHTLS Torso Trainer

**Pre-Hospital Trauma Life Support (PHTLS) Torso Trainer is perfect for the following medical emergency interventions as defined in the National Registry for EMT (NREMT) course curriculum:**

- Airway maintenance with basic and advanced adjuncts: intubation head with tongue, edema and laryngospasm options
- Chest trauma treatment: pneumothorax reduction
- IV therapy: IV arm
- I/O therapy: manubrium I/O insertion

**M-1021939**

### PHTLS Moulage Kit

This casualty simulation kit, with a focus on head and chest trauma, consists of strap-on and stick-on wounds from many other casual simulation kits. Its purpose is to augment the use of the PHTLS Trainers such as M-1021939 (presented on the left). For a detailed list of its components please refer to our website.

**M-1021940**



PLEASE REFER TO PAGE 38 TO SEE OUR MOULAGE & WOUND SIMULATION KITS



**Patient Education Tracheostomy Care Set**

*This trainer is ideal for teaching patients and caregivers the following tracheostomy care skills:*

- Suctioning techniques
- Proper cuff inflation
- Dressing changes
- Cleansing and maintenance of the external tracheal

**The Adult Manikin features:**

- Oral and nasal passages, pharynx, epiglottis, trachea, esophagus, tracheostomy site, and cricoid cartilage
- Flexible mouth and jaw for oral suctioning
- Trachea branches into the left and right bronchial trees

The infant manikin teaches parents and caregivers basic tracheostomy care skills, and is used extensively with children to comfort them and improve their self-esteem.

The set includes one adult and one infant manikin, one adult and one infant tracheostomy tube, instruction guide, and hard carry case.

**M-1021973**



**Tracheostomy Care Simulator**

The simulator replicates an adult male containing oral and nasal passages and all appropriate anatomy — pharynx, epiglottis, trachea, oesophagus, stoma, cricoid cartilage, and representative cervical vertebrae. The chest area contains left and right bronchi and the bronchial tree. The oesophagus “dead ends” 2” below the trachea opening. The side of the neck and chest area over the bronchial tree allow viewing of the suction and trachea tube. Viewing window at the bottom of the simulator to show the position of the suction catheter. Tracheostomy tube is not included.

53 x 28 x 53 cm; 11 kg

**M-1005592**



**Tracheotomy Trainer**

Practical trainer for various methods of tracheotomy, simulates a patient in a supine position with the neck extended. The trainee learns to determine the proper incision site while identifying arterial locations, and can observe intratracheal conditions from the head.

- Conventional tracheotomy (longitudinal, transverse, crucial, U-shaped, and inverted U-shaped incision)
  - Percutaneous tracheotomy
  - Puncture/incision into cricothyroid ligament
  - Incision pads can be used multiple times
- Delivered with 3 trachea pieces, 3 skins, lubricant oil (silicon oil), baby powder and storage case.

51 x 42 x 20 cm; 5 kg

**M-1021941**



**Life/form® NG Tube & Trach Skills Simulator**

The Life/form® NG Tube & Trach Skills Simulator has been developed to aid with the instruction, training and practice of vital tracheostomy skills and care for patients with respiratory conditions. The simulator is also designed for instruction of gastrointestinal care procedures through nasal and oral access. This simulator features realistic landmarks, trachea, esophagus, lungs and stomach.

**The simulator also allows for the practice of the following:**

- Dressing changes and cuff inflation
- NG tube care, including insertion, irrigation, and removal
- Gastric lavage and gavage
- Feeding tube insertion and removal with the ability to practice feeding
- Nasoenteric and esophageal tube care
- Oropharyngeal and nasopharyngeal care
- ET tube care

**M-1006058**



PLEASE VISIT [3BSCIENTIFIC.COM](http://3BSCIENTIFIC.COM) FOR A FULL FEATURE COMPARISON TO FIND A TRACHEOTOMY TRAINER THAT BEST FITS YOUR REQUIREMENTS





### Deluxe Cricothyrotomy Simulator

Designed for needle or surgical cricothyrotomy. Landmarks include thyroid cartilage, cricoid cartilage, and cricoid membrane. Inflation of simulated lung verifies correct placement. Adult and 3-year-old tracheas and soft carry bag included. With four overlay skins. 30.5 x 21.6 x 24.1 cm

**M-1017948**



### TruCric

The TruCric is a realistic training model for cricothyrotomy, percutaneous tracheostomy and air jet ventilation procedures. Easily replaceable consumables make the TruCric ideal for teaching and facilitating repeated technique practice. Includes a carrier case, user manual, lubricant, an adult lung bag, 10 larynx inserts, two wrap around neck skins and a non-slip mat.

**M-1021893**



### Cricotracheotomy Trainer

An extremely realistic alternative to using animal tissue or cadavers. The soft tissue has the feel of real skin and the unique trachea make it a very effective teaching and learning tool. Using a disposable trachea transforms the trainer into an effective low-cost system.

- Palpation of anatomical landmarks and needle cricothyroidotomy
- Practise surgical cricothyroidotomy with scalpel
- Identification of cricothyroid and thyroid cartilage
- Practise insertion of mini trach devices
- Use percutaneous tracheostomy kit or Seldinger approach
- Asses styled and obturator placement

**M-1005180**



### Cricothyrotomy Simulator

The newly designed Life/form® Cricothyrotomy Simulator has been developed for learning and practicing the techniques necessary to perform needle or surgical cricothyrotomy procedures.

- Anatomically accurate landmarks aid in site training and allow for fast action
- The hyperextended neck allows the user to determine the proper incision site. The trachea in the simulator is replaceable, as the airway passes completely through from top to bottom. This allows checking the stylet and obturator placement once the incision has been made complete with a chin and full-size neck, ties can be used to hold the obturator in a secure position. Inflation of the simulated lung verifies correct placement.

Includes the simulator with base, six replaceable neck skins, six adult trachea inserts (four rigid, two soft), six child trachea inserts (four rigid, two soft), two simulated lungs, instruction manual, and hard carry case.

**M-1020255**



➤ PLEASE REFER TO THE TABLE BELOW TO FIND A CRICOTHYROTOMY TRAINER THAT BEST FITS YOUR REQUIREMENTS



	Deluxe Cricothyrotomy Simulator	TruCric	Cricotracheotomy Trainer	Cricothyrotomy Simulator
Item No.	M-1017948	M-1021893	M-1005180	M-1020255
Surgical cricothyrotomy	✓	✓	✓	✓
Needle cricothyrotomy	✓	✓	✓	✓
Insertion of endotracheal tube	✓	✓	✓	✓
Full use of devices such as the PCK and UPK	-	✓	✓	✓
Seldinger technique	-	✓	✓	✓
Anatomical landmarks	Cricothyroid membrane	Cricothyroid membrane, laryngeal cartilages and tracheal rings	Cricothyroid membrane, chin and full-sized neck	Cricothyroid membrane, chin and full-sized neck
Review airway anatomy	-	-	✓	✓
Realistic soft skin	✓	✓	-	-
Confirm proper placement of endotracheal tube	Inflation of lung indicates proper placement	Inflation of lung indicates proper placement	-	Inflation of lung indicates proper placement
Simulation features	<ul style="list-style-type: none"> <li>Allows for an adult as well as pediatric cricothyrotomy</li> <li>Includes adult and 3-year-old tracheas</li> </ul>	<ul style="list-style-type: none"> <li>Neck skin can be rotated on the model allowing up to 20 incisions</li> <li>Larynx insert allows 1 surgical cricothyroidotomy and 3 tracheostomy procedures</li> </ul>	<ul style="list-style-type: none"> <li>Up to 36 incisions on each unit</li> <li>Up to 18 mini tracheostomies</li> </ul>	<ul style="list-style-type: none"> <li>Assessment of styled and obturator placement (replaceable trachea)</li> </ul>



### Pneumothorax Training Manikin

Designed for the practice of properly inserting a needle to permit built up air pressure to escape the thorax. The torso accepts needle thoracotomy in the second intercostal space in the midclavicular line, or the fifth intercostal space in the midaxillary line. Comes complete with replaceable lungs, a rib cage, and a soft, life-like replaceable skin. Unit can be punctured approximately 75 to 100 times before replacement is necessary.

**M-1005713**

#### Consumables and replacement parts:

Replacement lung	<b>M-1005737</b>
Replacement skin	<b>M-1005736</b>

### Endotracheal Intubation Simulator

Endotracheal intubations require highest skills and are accompanied by risks. This intubation simulator provides exceptionally good and realistic intubation training.

- Acquire both the skill of oral and nasal tracheal intubation
- Acquire the skill of handling supraglottic airway devices
- Confirm left and right air sounds with a stethoscope
- Determine ventilation of one lung

75 x 45 x 24 cm; 14 kg

**M-1005396**

#### Consumables and replacement parts:

Front teeth (set of 3)	<b>M-1005397</b>
Synthetic skin for the body	<b>M-1005399</b>



PLEASE REFER TO PAGE 66 TO SEE MORE AIRWAY MANAGEMENT TRAINERS



### Chest Drain Simulator

This innovative design not only simulates realistic body tissue but provides an alternative to the use of animal tissue. The design is unique in having a replaceable chest wall with ribs that are encased into the realistic simulated flesh that forms the torso. This fleshy part is replaceable and can be used for up to 25 incisions. It is housed in a white plastic torso-shaped box that is firmly secured and has strong suction feet to ensure non slip use on smooth table-top surfaces. The torso presents three patient positions: on the left side, on the back and in upright sitting position.

57 x 37 x 43 cm

**M-1005175**

#### Consumables and replacement parts:

Chest wall	<b>M-1005176</b>
Pneumothorax kit	<b>M-1005177</b>
Pericardiocentesis kit	<b>M-1005178</b>

**Life/form® Pericardiocentesis Simulator**

Designed specifically for skill training in pericardiocentesis, chest tube maintenance and the management of prehospital chest trauma. The simulator has a pressurized tension pneumothorax site and a site for the surgical placement of a functional chest tube. Fluid color, volume, and viscosity can be controlled by the instructor. Any commercially available closed water seal drainage unit can be used. Pericardiocentesis may be performed in the left subxiphoid space and in the left fifth intercostal space. Accurate placement of the needle will allow for the withdrawal of fluid from the simulated pericardium. Includes fluid reservoir bag, foot pump, surgical skin pads, subcutaneous surgical pads, nurse training pads, pneumothorax pads, blood powder, methyl cellulose thickener, simulated pericardium, IV bag, and a hard carrying case.

**M-1018828**

**Consumables and replacement parts:**

**Methyl cellulose** M-1005697  
**REN cleaner** M-1005776



**Life/Form® Chest Tube Manikin**

Comprehensive manikin to teach the theoretical knowledge and the practical skills needed to manage pre-hospital chest trauma as well as ongoing chest tube maintenance: The right side of the manikin has two cut-away viewing areas to provide awareness of the anatomical relationships between the skin surface, musculature, ribs and lungs. The left side has a pressurized tension pneumothorax site to relieve air that has accumulated within the pleural space and is restricting lung inflation. There is also a site where chest tubes may be surgically placed to treat pleural effusion by draining fluids from the pleural space. The fluid color, volume and viscosity is controlled by the instructor.

7.5 kg

**M-1017946**

**Consumables and replacement parts:**

<b>Surgical skin pads</b>	<b>M-1020243</b>
<b>Subcutaneous surgical pads</b>	<b>M-1020244</b>
<b>Pneumothorax chest pads</b>	<b>M-1020245</b>
<b>Simulated pericardium, (set of 10)</b>	<b>M-1021786</b>
<b>REN cleaner</b>	<b>M-1005776</b>



# RESCUE



## > TRAIN FIRE RESCUE AND EXTRICATION

### Rescue Randy

- Fully articulated for positioning in widely diversified training environments
- Made of tough cast vinyl with zinc-plated steel frame for longevity and rugged use
- Adult and juvenile manikins with different sizes and weights
- Training examples: Extrication, fire rescue, and mountain rescue training. Patient immobilization and removal of victims from vehicles, utility poles, conduits, mine cave-ins, and tunnels

**Juvenile Rescue Manikin Jennifer, 1.22 m tall**  
7 kg    **M-1005704**

**Adult Rescue Manikin Randy, 1.67 m tall**  
25 kg    **M-1005700**  
47 kg    **M-1005701**  
65 kg    **M-1005702**  
74 kg    **M-1005703**

**Adult Rescue Manikin Randy, 1.83 m tall**  
65 kg    **M-1005768**  
74 kg    **M-1005769**



### CasPeR the CPR Dog

CasPeR the CPR Dog provides training in mouth-to-snout resuscitation with individual-use, disposable airway bags. This dog manikin can be used for emergency training with CPR: proper hand placement for compressions, depth of compressions, airway maintenance, femoral pulse check, and adequate ventilation. Airways are changed quickly and without tools.

**M-1020264**

## > Can be filled with water or sand to adjust the weight

### Rescue Randy 9000

The manikin is made from rugged polyethylene parts that allow for the addition of varying amounts of weight to each of the pieces. The empty manikin is easily moved and stored when training is completed. Randy 9000 is perfect for RIT (Rapid Intervention Team) trainings or Combat Challenges as well as ship-board, heavyweight, horizontal rescues or lightweight packaging exercises like spinal immobilization. Weight: 77 kg when filled with water, 113 kg with sand.

1.83 m tall, approx. 30 kg  
**M-1017945**



### Flexible Rescue Randy

Developed especially for the aerospace industry and wing tank fuel cell rescue training, this regular sized Rescue Randy unit can be utilized in any confined space rescue scenario. The waist and head are flexible allowing a wide range of movements. This allows positioning under dashboards and in other extremely tight spots. 1.65 m tall, approx. 27 kg

**M-1017944**



### I.A.F.F. Rescue Randy

#### Strengthened for Extrication Training

Designed with the help of the International Association of Fire Fighters (I.A.F.F.). Developed for life-like adult or juvenile patient handling and transportation. Includes additionally reinforced frame to increase durability for the forces used in extrication training.

- Fully articulated for positioning in widely diversified training environments
- Weight distribution according to human weight distribution chart

1.83 m tall, approx. 84 kg  
**M-1019955**



## ➤ TRAIN CPR WATER RESCUE AND RETRIEVAL

### Pediatric Water Rescue Manikin

These manikins allow coast guards, lifeguard trainers, and emergency personnel to train water rescue and retrieval. When filled with water the manikins will sink to the bottom.



- Excellent top and bottom water rescue device
- + Will sink to the bottom when filled with water
- + Have articulating joints
- + Made of durable plastic and rust-resistant steel



### Child Water Rescue Manikin

3-Year Old Water Rescue Manikin  
Weight when filled with water: 9 kg  
**M-1005739**

### Infant Water Rescue Manikin

6 – 9 months old  
Weight when filled with water: 5.5 kg  
**M-1018327**

### Newborn Water Rescue Manikin

Weight when filled with water: 3.2 kg  
**M-1005699**

### Adult and Adolescent Water Rescue Manikins

Perfect for coast guards, lifeguard trainers, and emergency personnel to train water rescue and retrieval as well as CPR. The manikins have articulated joints and are made of durable plastic and rust-resistant steel. When filled with water the manikins will submerge to the neck, if an additional 2 or 4 kg (a brick will do) is added, they will sink completely.

Also available without the CPR option. Train both water rescue and retrieval as well as CPR.

- CPR and water rescue training in one manikin
- Made of durable vinyl plastic with rust-resistant stainless steel skeletons, and articulated joints
- When filled with water, CPR manikins will sink (a flotation device is needed)
- Delivered with 5 mouth/nosepieces, 5 airway systems, and shorts
- Training examples: Water rescue, water retrieval, and CPR

### Adolescent Water Rescue Manikin

1.22 m, 9 kg  
**M-1021971**

### CPR Adolescent Water Rescue Manikin

1.22 m, 9 kg  
**M-1018325**

### Consumables and replacement parts:

**24 Airway Systems**  
**M-1005735**  
**10 Mouth/Nose Pieces**  
**M-1018326**

### Adult Water Rescue Manikin

1.64 m, 13 kg  
**M-1021970**

### CPR Adult Water Rescue Manikin

1.64 m, 13 kg  
**M-1005767**

### Consumables and replacement parts:

**24 Airway Systems**  
**M-1005765**  
**10 Mouth/Nose Pieces**  
**M-1005741**



# MOULAGE AND WOUND SIMULATION

► REALISTIC TOOLS FOR LIFE-LIKE EMERGENCY MEDICAL TRAINING!



## Basic Casualty Simulation Kit

The most economical way to get started in simulated injuries. Re-useable wounds and refillable accessories let you practice bandaging and splinting techniques repeatedly.

### **Includes:**

#### **Bleeding wounds:**

1 Compound fracture tibia

#### **Non-bleeding wounds:**

12 Assorted stick-on lacerations and open fractures

Comes complete with basic makeup accessories (including acrylic to simulate glass embedded wounds) for basic injury simulation and reservoir bags with pump assembly.

33 x 25.5 x 13 cm; 2.3 kg

**M-1005708**

## Advanced Casualty Simulation Kit

For more complex wounds to test higher levels of skill in bandaging and patient care while keeping initial expenditures low.

### **Includes:**

#### **Bleeding wounds:**

Open amputation, compound fracture of humerus, and compound fracture of tibia. Sucking wound of chest, gunshot wound of palm.

#### **Non-bleeding wounds:**

24 Assorted stick-on lacerations and open fractures

Comes complete with makeup accessories (including acrylic to simulate glass embedded wounds, blood powder for 13.5 liters) for complex injury simulation and reservoir bags with pump assembly.

25.5 x 23 x 46 cm; 4.1 kg

**M-1005709**



## Advanced Military Casualty Simulation Kit

Especially suitable for use in the creation of disaster scenarios where application of makeup on multiple casualties creates the widest range of wounds. Contains speciality wounds associated with gunshots, like perforations, major avulsions, and complex jaw wounds.

### **Includes:**

#### **Bleeding wounds (complete with reservoir bags with pump assembly):**

Compound fractures of humerus and tibia

#### **Non-bleeding wounds:**

Assorted stick-on lacerations and open fractures

Comes complete with makeup accessories (including acrylic to simulate glass embedded wounds, blood powder for 13.5 liters, latex compound, and plastalene modeling paste) for advanced injury simulation and reservoir bags with pump assembly.

41 x 33 x 56 cm; 12.3 kg

**M-1005710**



MORE ADVANCED TRAUMA LIFE SUPPORT PRODUCTS ON PAGE 28

### Xtreme Trauma Moulage Kit for TCCC Training

This trauma moulage kit represents wounds that result from explosions and chemical disasters. The simulated trauma wounds will assist in training exercises for military and government responders and anyone providing treatment to victims injured in disasters and war.

#### The kit includes 12 wound sets:

- Bleeding exposed denture avulsion
- Bleeding major muscle laceration
- Bleeding open ankle dislocation
- Bleeding open humerus fracture
- Bleeding open rib fracture
- Bleeding open skull fracture
- Bleeding open wrist fracture
- Bleeding skin laceration
- Burned face
- Dorsal hand 4<sup>th</sup> degree chemical burn
- Half-face chemical burn
- Right hand 4<sup>th</sup> degree chemical burn

**M-1021948**



### Weapons of Mass Destruction Kit

Improve medical care training for wounds associated with Weapons of Mass Destruction (WMD) or Chemical-Biological-Radiological-Nuclear-Explosive (CBRNE) attacks.

- Face masks release fluids to mimic reactions such as sweating, tearing, nasal discharge, and mouth excretions
- Other face masks feature varying stages of smallpox, anthrax, and chemical burns
- Stick-on wounds show Improvised Explosive Device (IED) damage, and various stages of disease states
- Strap-on wounds include below-the-knee and below-the-elbow amputations

#### The kit comes in a rugged carry case and includes the various makeup and accessories listed below:

- 100 Tongue depressors
- 1 Coagulant blood
- 1 Methyl cellulose
- 1 Blood powder
- 1 Body adhesive
- 1 Casualty simulation wax
- 1 White grease paint
- 1 Brown grease paint
- 1 Blue grease paint
- 1 Red grease paint
- 1 Powdered charcoal
- 1 Atomizer
- 6 Makeup sponge wedges
- 1 Baby powder

**M-1021949**



### Emergency Medical Treatment (EMT) Casualty Simulation Kit

This complex Emergency Medical Training kit uses components applied to human and manikin patients to get the widest variety of training situations possible. Wounds strapped on, stuck on, created from wax and made to bleed challenge both the volunteer and the professional in areas of burns, lacerations, fractures of arms



and legs and amputations; a good kit to simulate community disasters like bus accidents, or building explosions.

#### The emergency medical training kit is supplied in a storage case and includes:

##### Makeup accessories:

- 1 Mirror
- 1 Body adhesive for stick-on wounds
- 2 Casualty simulation wax
- 3 Bottles coagulant make-up blood
- 5 Pkg. blood powder, each for 4.5 liter simulated blood
- 1 Pkg. methyl cellulose for blood thickening
- 4 Grease paint colors: white, blue, brown and red
- 2 Pkg. broken Plexiglas® for simulating glass embedded wound
- 1 Cold cream
- 2 Atomizer mist sprayer
- 2 Plasticine modeling paste: white and dark
- 6 Tongue depressors
- 1 Pkg. of tissues
- 2 Fake dirt
- 1 Charcoal
- 1 Petroleum jelly
- 2 Spatulas

**M-1005711**

# ADVANCED LIFE SUPPORT ADULT

## Life/form® Adult CRiSis™ Manikins

Complete resuscitation system that presents challenges you may face in real world situations, with five major features allowing practice of several simulation scenarios. It is ideal for Advanced Life Support (ALS) courses aimed to teach resuscitation guidelines and skills to healthcare professionals. Modular components allow you to create a manikin to suit your needs.

### Airway Management

- Compatible airway management devices include E.T., E.O.A., E.T.L., L.M.A., E.G.T.A., Combitube®, and King Systems
- Cricoid cartilage allows for practice of Sellick maneuver
- Oral, nasal, and digital intubation
- Palpable carotid pulse (manual)
- Separate left and right lungs for auscultation
- Suctioning capabilities

### Defibrillation Chest

- Compatible with all standard brands and types of defibrillators, monitors, and patient simulators
- Internal load box absorbs full strength of every shock — designed to handle up to maximum recommended 360 joules
- Manual, semiautomatic, and automatic defibrillation
- Monitor manikin like a real patient at 4 ECG sites and 2 defibrillation sites

### CPR

- Fully articulated head, neck, and jaw
- Jaw thrust
- Palpable and visual landmarks

### Blood Pressure Arm

- Auscultatory gap
- 5 Korotkoff phases
- Systolic and diastolic levels, heart rate, and sound volume
- Radial pulse
- Use with an optional external speaker system to broadcast sounds to the entire classroom

### IV Arm

- Articulated at the biceps for antecubital and dorsal access
- Bony landmark at shoulder to identify muscle tissue for intramuscular injections
- Realistic flashback from a pressurized system
- Replaceable skin and veins



	Deluxe CRiSis™	Deluxe Plus CRiSis™ Manikin with CPR Metrix and iPad®	Deluxe Plus CRiSis™ Manikin with Advanced Airway Management, CPR Metrix, and iPad®
Item No.	M-1021988	M-1022168	M-1022169
Airway management	✓	✓	✓
Laryngospasm and tongue edema	-	-	✓
Blood pressure arm	✓	✓	✓
CPR	✓	✓	✓
Defibrillation chest	✓	✓	✓
IV arm	✓	✓	✓
CPR Metrix and iPad®	-	included	included
Interactive ECG Simulator	included	included	included
Auscultation and 7 lung sites via SmartScope™	optional M-1019786	optional M-1019786	optional M-1019786
Carrying case	optional M-1021990	included	included



**Model shown:**  
**Deluxe Plus CRiSis™ Manikin with**  
**CPR Metrix and iPad®**  
**M-1022168**



➤ **WORKS WITH ALL CPR TRAINERS!**

**Heartisense™ Premium Kit**

Upgrade your existing CPR manikin into a smart CPR manikin by using Heartisense™. It controls up to 6 manikins at a time and enables accurate and effective training and assessment.

- Real-time feedback and a realistic interface
- Perform compressions, ventilations or both
- Digitally saves all training and assessment data

Student app runs on Android™ or Apple® tablet or phone and instructor app runs on iPad® or Android™ tablet (not included).

**M-1022167**



Complete Adult CRiSis™	Complete CRiSis™ with Advanced Airway Management	Deluxe CRiSis™ with ECG and Advanced Airway Management	Deluxe CRiSis™ with Advanced Airway Management and Auscultation	Deluxe Plus CRiSis™ Auscultation Manikin with CPR Metrix and iPad®	CRiSis™ Torso	Deluxe CRiSis™ Torso	Deluxe CRiSis™ Torso with Advanced Airway Management
M-1019919	M-1021987	M-1021989	M-1020049	M-1022170	M-1013723	M-1005650	M-1021991
✓	✓	✓	✓	✓	✓	✓	✓
-	✓	✓	✓	-	-	-	✓
✓	✓	✓	✓	✓	-	-	-
✓	✓	✓	✓	✓	✓	✓	✓
✓	✓	✓	✓	✓	✓	✓	✓
✓	✓	✓	✓	✓	-	-	-
-	-	-	-	included	-	-	-
-	-	included	included	included	-	included	included
optional M-1019786	optional M-1019786	optional M-1019786	included	included	optional M-1019786	optional M-1019786	optional M-1019786
optional M-1021990	optional M-1021990	optional M-1021990	optional M-1005651	optional M-1005651	optional M-1005651	optional M-1005651	optional M-1005651



# ADVANCED LIFE SUPPORT CHILD

## Life/form® Child CRiSis™ Manikins

This complete resuscitation system is designed for teaching individuals or groups life-saving techniques for children. It provides complete Pediatric Advanced Life Support (PALS) training capabilities and combines all of the skill stations on one manikin, making training more realistic and giving students an appreciation for the smaller scale of the patient. Simulates a 5-year old child, 118 cm tall and 9 kg in weight.

### Airway Management

- Compatible airway management devices include E.T., E.O.A., E.T.L., L.M.A., E.G.T.A., Combitube®, and King Systems
- Inflatable stomach bladder to indicate esophageal intubation
- Oral, nasal, and digital intubation capabilities
- Realistic anatomical features
- Separate left and right lungs for auscultation
- Suctioning capabilities

### Intraosseous Infusion

- Palpable landmarks include the patella, tibia, and tibial tuberosity
- Pressurized system allows aspiration of fluid
- Replaceable bones and skin

### Blood Pressure Arm

- Auscultatory gap
- Systolic and diastolic levels, heart rate, and sound volume
- Palpable radial pulse
- Speaker in arm reproduces real blood pressure sounds
- 5 Korotkoff sounds

### Consumables and replacement parts for Child CRiSis™ Manikins:

<b>Blood Pressure Cuff</b>	<b>M-1019717</b>
<b>Blood Pressure Electronic Box</b>	<b>M-1019718</b>
<b>IV Arm Child</b>	<b>M-1019790</b>
<b>Blood Pressure Arm</b>	<b>M-1019791</b>
<b>IO and Femoral Access Leg</b>	<b>M-1019792</b>

### CPR

- Fully articulated head, neck, and jaw thrust
- Visual landmarks and palpable carotid pulse (manual)

### IV Arm

- Articulated at the biceps for antecubital and dorsal access
- Realistic flashback from a pressurized system

### Defibrillation Chest

- Compatible with all standard brands and types of defibrillators, monitors, and patient simulators
- Internal load box absorbs full strength shock
- Manual, automatic, and semi-automatic defibrillation
- Rhythms are detected at 4 ECG sites and 2 defibrillation sites

### Femoral Access

- Palpable arterial pulse (manual)
- Palpable symphysis pubis and anterior superior iliac spine
- Realistic flashback from pressurized venous system

**Artificial Blood, 1 liter**

**M-1017611**

**Replacement Skin and Vein Kit**

**M-1005654**

**Interactive ECG Simulator**

**M-1005666**



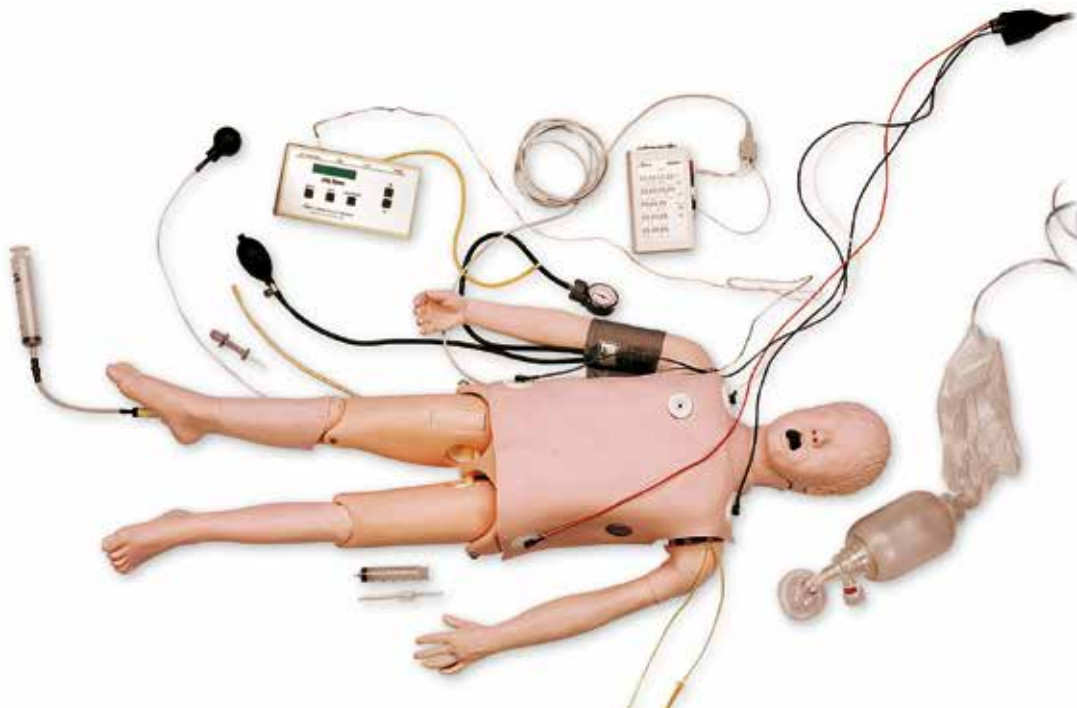

**Model shown:  
Deluxe Child CRiSis™ Manikin  
with ECG Simulator  
M-1005624**



**Blood Pressure Arm  
M-1019791**



**IO and Femoral Access Leg  
M-1019792**

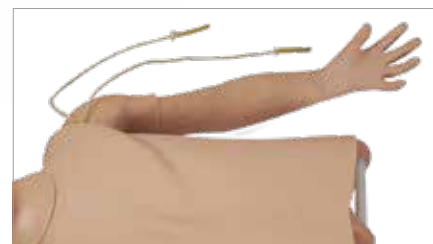

**IV Arm Child  
M-1019790**

	Basic Child CRiSis™	Basic Child CRiSis™ with Advanced Airway Management	Complete Child CRiSis™	Complete Child CRiSis™ with Advanced Airway Management	Deluxe Child CRiSis™ with ECG	Deluxe Child CRiSis™ with Advanced Airway Management
Item No.	M-1021992	M-1021993	M-1021994	M-1021995	M-1005624	M-1021996
Airway management	✓	✓	✓	✓	✓	✓
Laryngospasm and tongue edema	-	✓	-	✓	-	✓
Blood pressure arm	-	-	✓	✓	✓	✓
CPR	✓	✓	✓	✓	✓	✓
Defibrillation chest	-	-	✓	✓	✓	✓
Femoral access leg	-	-	✓	✓	✓	✓
Intraosseous infusion	-	-	✓	✓	✓	✓
IV arm	-	-	✓	✓	✓	✓
Interactive ECG simulator	optional M-1005666	optional M-1005666	optional M-1005666	optional M-1005666	included	included
Carrying case	optional M-1005651	optional M-1005651	optional M-1005651	optional M-1005651	optional M-1005651	optional M-1005651

# ADVANCED LIFE SUPPORT INFANT



**Monitor not included**



## NENAsim Infant Manikins

NENAsim series is an extremely realistic neonatal human patient simulator, with set ups for different training purposes such as Basic Patient Care, Basic Life Support, Advanced Life Support as well as advanced medical scenario and treatment training.

Realistic anatomy, life-like silicone skin and flexible limbs are standard features of NENAsim. These full-body trainers are wireless, easy to disinfect, about 65 cm tall and delivered in a sturdy suitcase with wheels.

### NENAsim HPS

NENAsim HPS was created to complement realistic multidisciplinary team or individual baby patient simulation training. NENAsim is a neonatal, high-end simulator with an unprecedented level of realism and offers an ideal training solution for a wide range of healthcare professionals including patient care, emergency medical intervention and resuscitation training.

### Software

The NENAsim HPS patient software is a perfect tool for training neonatal examination. The trainer can choose from one of the 5 available standard scenarios or build their own. New parameters can be added at any time in order to alter the existing scenarios. Individual as well as team trainings with different language options are possible. Trainees learn from monitoring the displayed parameters – it enables them to deduce the correlation between the measured values and the clinical picture of the patient, thus helping in recognizing and managing pediatric emergencies.

### Realistic Anatomy

NENAsim HPS has a life-like appearance and movement of the eyes, head and neck. The silicone skin changes its temperature, whereas no visible artificial joints make its outer appearance even more realistic. Variable breathing patterns as well as torso motion can be controlled via provided software.

### Airway Management

NENAsim HPS allows performing of all aspects of neonatal airway management training and gives trainees the necessary confidence to deal with their little patients in the future.

### Auscultation and sounds

Lung: Normal, stridor, pneumonia and others  
Heart: Normal, diastolic murmur, systolic murmur and others  
Possible for users to add more sounds of their choices.

### CPR

NENAsim HPS has been designed to teach the fundamentals of infant CPR and trauma care. Open the airway by tilting NENAsim's head and chin, and begin the resuscitation.

### Blood circulation

Blood pressure, pulse rate and respiratory rate are the routine vital signs measured in neonatal care. NENAsim offers versatile BP and ECG features, all of which can be controlled and displayed on the monitor.

### Additional Features

Wireless autonomous local network broadcasts its own signal so the training can be organized anywhere or with any scenarios (outdoor, accident, emergency and not only in clinical setup).

55 x 61 x 23 cm; 5 kg

**Light Skin** M-1020899

**Dark Skin** M-1018876





**CPR and trauma care**



**Heart and lung sounds**



**Oral and nasal intubation**

**▶ PLEASE TAKE A LOOK AT THE TABLE BELOW TO FIND THE NENAsim SIMULATOR THAT BEST FITS YOUR REQUIREMENTS**

	Infant Care	Infant ALS	Infant ALS with Basic Software	Infant ALS+ with Basic Software	Infant Human Patient Simulator (HPS)
Item No.	Boy M-1021099 Girl M-1021098	Boy M-1021103 Girl M-1022691	Boy M-1021104 Girl M-1021105	Boy M-1021106 Girl M-1021107	Light Skin M-1020899 Dark Skin M-1018876
<b>Patient care procedures</b>	✓	✓	✓	✓	✓
<b>Airway management</b>					
Realistic airway, vocal cords, trachea and esophagus	-	✓	✓	✓	✓
Intubation, oxygen delivery procedures	-	✓	✓	✓	✓
Spontaneous breathing with movement	-	-	-	✓	✓
<b>CPR</b>					
Head tilt, chin lift and jaw thrust	-	✓	✓	✓	✓
CPR compressions	-	-	-	✓	✓
Live defibrillation, pacing and cardioversion	-	-	-	-	✓
Software feedback on CPR	-	-	✓	✓	✓
<b>Cardiovascular</b>					
ECG & 12 lead display	-	-	-	-	✓
Palpable pulse (femoral, axillary, fontanel)	-	-	-	-	✓
Blood circulation vital signs	-	-	✓	✓	✓
<b>Auscultation &amp; Sounds</b>					
Vocal sounds as well as heart, lung and bowel sounds	-	-	-	-	✓
Bilateral normal and abnormal breath sounds	-	-	-	-	✓
Wireless stethoscope	-	-	-	-	✓
<b>Additional features</b>					
IV arm, IO leg	-	-	-	-	✓
Head and eyelid movement	-	-	-	-	✓
Software features	-	-	basic	basic	advanced
Weight	5 kg	2.5 kg	2.5 kg	5 kg	5 kg

### STAT Baby Basic

STAT Baby Basic brings you an extremely life-like simulator for infant care by utilizing new materials for tactile awareness during patient assessment. Developed in conjunction with leading pediatric physician involvement, this baby contains a wide range of skill sets in a simple format that is very affordable. The infant is sized to a 9-month-old. STAT Baby Basic includes the same standard features as STAT Baby Advanced M-1020195. Does not include the iPad®.

#### Comes with:

- IV vein kit (1 arm and 1 leg)
- Leg skin
- Arm skin
- IO leg bones
- Pneumothorax sites
- Injection site
- Picc line site
- Reservoir bag
- Defibrillator adaptor
- ECG interactive simulator
- Simulated blood powder

6.8 kg  
**M-1005779**



### Both STAT Babies have the following features:

- + 7 pulse points
- + I/O leg
- + 3 IV sites
- + PICC access site
- + IM/SQ injection sites
- + Advanced intubation head with tongue edema and laryngospasm
- + Pneumothorax reduction bilaterally
- + 4-lead monitoring
- + Chest tube insertion (left side only)
- + Defibrillation
- + Rectal medication
- + Urinary catheterization
- + Very life-like new skin material
- + Accepts LMA, ET, OPA, NPA, and LT airways



### STAT Baby Advanced

STAT Baby Advanced has all the features of a STAT Baby, but utilizes easy-to-use iPad® technology. It gives the instructor control of the physiological features of the baby to deliver challenging training to develop student assessment skills and easily tracks sessions for later review and debriefing. Key functions include managing student information, easily create alternate scenarios or use those already existing, and efficient records management of the training, all managed through an easy iPad® interface. It satisfies every training need for post-neonatal care of pediatric patients, from introducing students to basic concepts to challenging medical staff in advance medical procedures.

#### Also includes these additional features:

- Sternal retraction
- Fully enclosed crib with waterproof surface
- 183 cm tether assembly so that the baby can be handled
- Aneroid blood pressure cuff
- Heart sounds
- Lung sounds
- Voice sounds
- Spontaneous breathing

The STAT Baby Advanced comes with its own iPad®.  
140 x 71 x 28 cm

**M-1020195**

**Life/form® C.H.A.R.L.I.E. Neonatal Resuscitation Simulator without Interactive ECG**

- C:** Compressions, Cardiac
- H:** Heat compatible
- A:** Airway, Arterial access via the umbilicus
- R:** Resuscitation
- L:** Laryngeal mask capable for oxygen use or PPV
- I:** Intravenous, Intraosseous, Intubation
- E:** ECG

**Features of the C.H.A.R.L.I.E. Manikin include:**

- Airway, breathing, intubation and ventilation
- Birth anomalies
- Chest tube placement
- CPR
- ECG simulation
- Gastrointestinal (GI) tube
- Interchangeable genitalia
- Intraosseous infusion
- IV hand and foot
- Observation and measurement
- Palpable manual pulse points in 7 locations
- Patent umbilicus with venous and arterial access
- PICC site in arm
- Urinary catheterization

**M-1021584**



**Consumables and replacement parts:**

<b>Bilateral Chest Rise</b>	<b>M-1021590</b>
<b>Unilateral Chest Rise</b>	<b>M-1021591</b>
<b>IV Hand Skin and Veins</b>	<b>M-1021597</b>
<b>Airway</b>	<b>M-1021594</b>
<b>V Foot Skin and Veins</b>	<b>M-1021598</b>
<b>Birth Defects – Set of 2</b>	<b>M-1021599</b>
<b>Advanced Airway</b>	<b>M-1021611</b>
<b>Defibrillation Chest</b>	<b>M-1021612</b>
<b>Genitalia – Male and Female</b>	<b>M-1021613</b>
<b>I/O Skin</b>	<b>M-1021614</b>
<b>Umbilicus with Pulse</b>	<b>M-1021615</b>
<b>I/O Bone and Blood Capsule – Pack of 12</b>	<b>M-1021616</b>



**SEE PAGES 111 FOR MORE PEDIATRIC PATIENT CARE SIMULATORS**



**PALS Manikin with ECG-Simulator**

This simulator model of a female infant allows practice of a wide range of pediatric ALS techniques. Soft carrying bag included.

**Features of the PALS Manikin include:**

- Bag valve mask ventilation
- Oral and nasal intubation including Sellick’s maneuver
- Placing of NG tube
- Three lead ECG monitoring (16 different arrhythmias with adjustable heart rate)
- Palpation of brachial pulse
- External chest compressions
- Movable jaw
- IV sites in hand and arm for blood sampling or fluid injection
- Intraosseous needle insertion and aspiration of bone marrow in both legs
- Palpation of scalp vein, cranial sutures and fontanelles

57 cm; 3 kg

**M-1005759**

## Life/form® Infant CRiSis™ Manikins

This complete resuscitation system is designed for teaching life-saving techniques for infants. It is ideal for Pediatric Advanced Life Support (PALS), nursing, hospital, paramedic, and emergency training at every level. Anatomical landmarks provide key features necessary to learn proper infant handling in emergency situations.

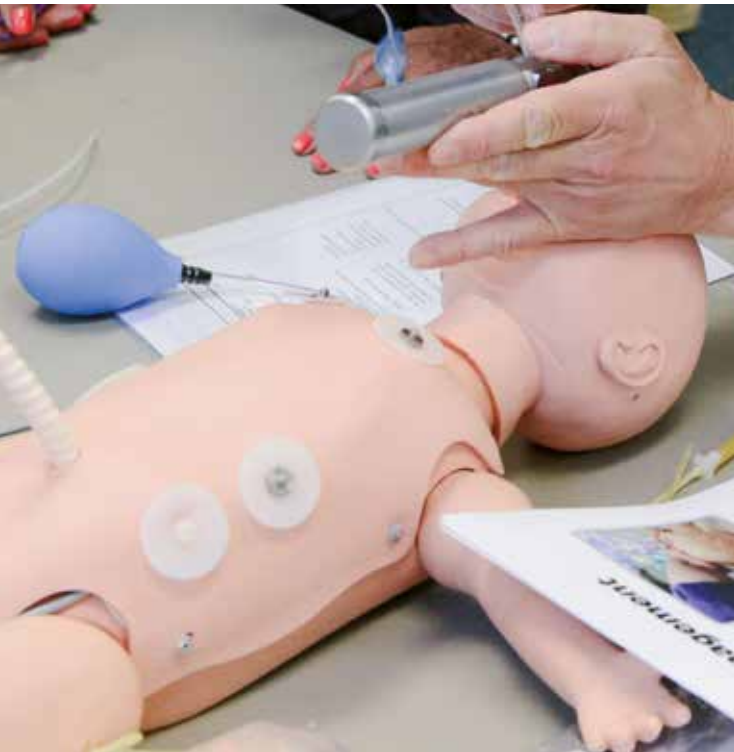

### Airway Management

- Oral and digital intubation capabilities
- Realistic anatomy of the mouth, tongue, oral pharynx, larynx, epiglottis, vocal cords, trachea, and esophagus
- Suctioning capabilities

### CPR

- Fully articulated head, neck, and jaw
- Jaw thrust
- Palpable and visual landmarks
- Palpable brachial pulse (manual)

### ECG/Umbilical Cannulation Skin

- Allows practice of umbilical cannulation, cutting, and clamping
- Arrhythmia recognition
- Aspirate fluid through the umbilicus
- Learn proper techniques in umbilical catheterization

### Intraosseous Infusion

- Palpable landmarks include the patella, tibia, and tibial tuberosity
- Pressurized system allows aspiration of fluid
- Replaceable bones and skin

### IV Arm & Leg

- Realistic flashback from a pressurized system
- Replaceable skin and veins
- Smaller lumen tubing simulates the size of an infant's veins

	Basic Infant CRiSis™	Intermediate Infant CRiSis™	Complete Infant CRiSis™	Deluxe Infant CRiSis™
Item No.	M-1017248	M-1021997	M-1005658	M-1018146
Airway management	✓	✓	✓	✓
CPR	✓	✓	✓	✓
ECG/Umbilical cannulation Skin	-	-	✓	✓
Intraosseous infusion	-	✓	✓	✓
IV arm	-	✓	✓	✓
IV leg	-	✓	✓	✓
Interactive ECG arrhythmia simulator	optional (M-1005666)	optional (M-1005666)	optional (M-1005666)	included
Carrying case	included	included	included	included



PLEASE REFER TO PAGE 42 TO FIND OUT MORE ABOUT CHILD CRiSis™ MANIKINS





**Model shown:**  
**Deluxe Infant CRiSis™**  
**M-1018146**



**Infant IV Leg M-1017950**



**Infant IV Arm M-1017949**



**Single Intraosseous Infusion  
 Leg M-1017951**



**ECG/Umbilical Cannulation  
 Skin M-1017952**

**Consumables and replacement parts for Life/form® Infant CRiSis™ Manikins:**

Infant IV Arm	M-1017949	Intraosseous Leg Replacement Skin (Pkg. of 4) and Bones (Pkg. of 10)	M-1005659
IV Arm Replacement Skin/Veins	M-1005662	Intraosseous Infusion Needle (15 gauge)	M-1005660
Fluid Supply Bag, 500 ml	M-1005693	Bone Replacement Kit	M-1019796
Artificial Blood, 1 liter	M-1005611	ECG/Umbilical Cannulation Skin	M-1017952
Infant IV Leg	M-1017950	6 Umbilical Clamps	M-1005664
IV Leg Replacement Skin/Veins	M-1005661	Interactive ECG-Simulator	M-1005666
Single Intraosseous Infusion Leg	M-1017951		

### PREMIE™ Blue Simulator with Smartskin™ Technology

28-week premature infant manikin that includes an injection arm as well as an intraosseous leg. Students can intubate and perform BVM and CPR exercises. The skin changes color in direct response to the treatment, a great way of measuring training success. This is intensified by the possibility to track rates of improvement and deterioration on the monitor.

#### Realistic training of neonatal intensive care:

- Simulate “heelstick” maneuver for capillary blood sample
- Oral and nasal intubation and suction procedures
- Bilateral lung expansion with realistic chest rise
- Distinguishing peripheral and central cyanosis from healthy skin tone
- Feeling pulse umbilicus
- Practice placement of umbilical lines
- Simulate CPR with either two-thumb “encircling” technique or two finger alternate compression method
- Practice delicate intraosseous access
- Practice injection and intravenous techniques

#### Simulator components included:

- PREMIE™ Blue neonate
- Omni® Controller for managing cyanosis and monitoring CPR
- Omni® Code Blue® pack
- International power supply 100-240 VAC
- Connecting cables, instruction manual, carrying bag

**M-1018862**

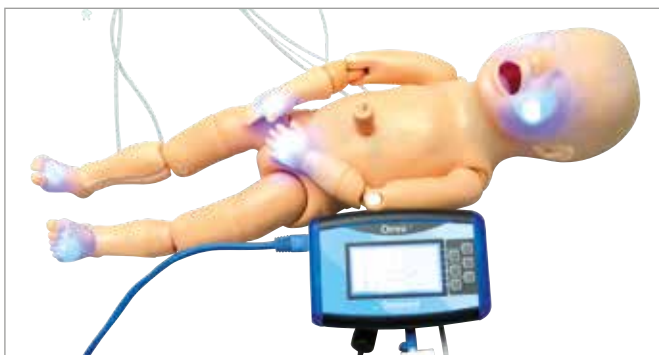

### PEDI® Blue Neonatal Simulator with SmartSkin™ Technology

A spectacular newborn simulator which changes color based upon an initial pre-selected condition and measures the effectiveness of airway ventilation and chest compression. In addition, the simulator has all the conventional features found in airway management trainers. Can be upgraded with an intraosseous leg and an injection training arm.

#### Simulator components included:

- PEDI Blue neonate
- Omni® Controller for managing cyanosis and monitoring CPR
- CPR
- Omni® Code Blue® pack
- International power supply 100-240 VAC
- Connecting cables, instruction manual, carrying bag

**M-1013066**

### PEDI® Neonatal Simulator

This anatomically accurate newborn simulator features a fully articulating head, neck, and jaw, permitting head tilt/chin lift, jaw thrust and neck extension. Realistic mouth, trachea, bronchi, lungs, and distensible stomach for practicing gastric suctioning and feeding exercises. Airway with crico cartilage permits intubation, suctioning, and the Sellick maneuver. Realistic internal organs for unparalleled CPR performance. Includes carrying bag.

#### This simulator is ideal for training:

- Airway management
- Femoral IV
- Intravenous access
- Umbilical catheterization
- IO access

**M-1014584**



**Susie® and Simon®** product series is designed to teach the fundamentals of infant CPR and trauma care. These life supporting training simulators feature fully articulating head and jaw with tongue, SAFE CPR™ individual disposable airways, arterial pulse sites and soft, life-like faceskin with molded hair. The Susie® and Simon® airway is blocked when the head is forward, and the chest cavity with molded ribcage, lungs and heart is easily accessible. It has a realistic chest rise during ventilations and multiple arterial pulse points which enhance the effectiveness of the training.

**The Omni® Code Blue® pack** is a hand held controller which monitors and logs the cadence and depth of cardiac compression and airway ventilation. Connect Omni® to your simulator using a wired connection and:

- Allow Omni® to automatically detect the simulator and display its specific menus
- Control the simulator functions
- Display compressions and ventilations in real time
- Train CPR with audible coaching tones
- Connect to a PC and monitor, view, store and print results of CPR exercises

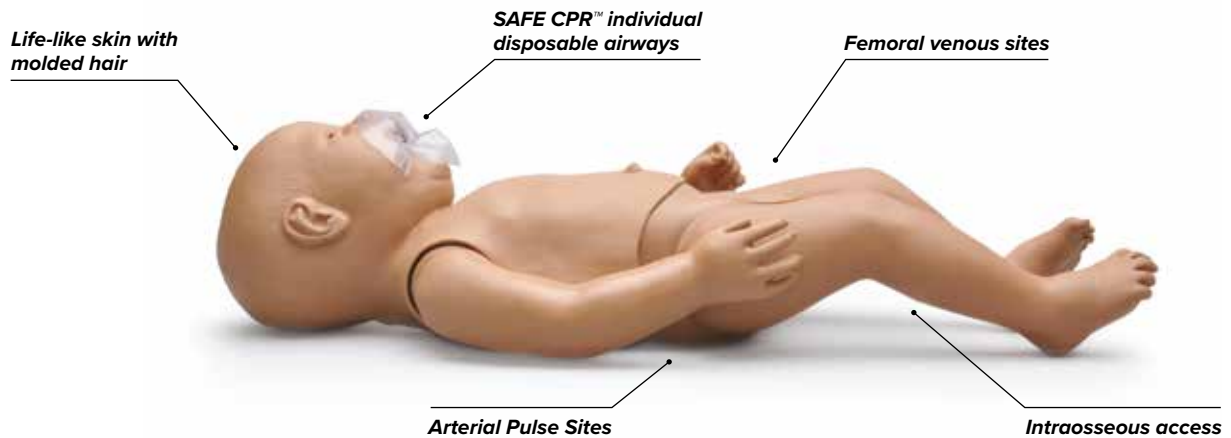

➤ PLEASE TAKE A LOOK AT THE TABLE BELOW TO FIND A SUSIE® AND SIMON® SIMULATOR THAT BEST FITS YOUR REQUIREMENTS

	CPR and Trauma Care	CPR and Trauma Care with Code Blue® Monitor	CPR and Trauma Care with Intraosseous and Venous Access	CPR and Trauma Care with Code Blue® Monitor plus Intraosseous and Venous Access
Item No.	M-1018866	M-1017560	M-1017561	M-1014570
CPR	✓	✓	✓	✓
Fully articulating head and jaw with tongue	✓	✓	✓	✓
SAFE CPR™ individual disposable airways	✓	✓	✓	✓
Arterial Pulse Sites	✓	✓	✓	✓
Omni™ Code Blue® pack	-	✓	-	✓
Intraosseous access	-	-	✓	✓
Femoral venous site	-	-	✓	✓
Life-like faceskin with molded hair	✓	✓	✓	✓
T-shirt and shorts	✓	✓	✓	✓
Carrying bag	included	included	included	included
Instruction manual	included	included	included	included

# BASIC LIFE SUPPORT (BLS) ADULT

3B SCIENTIFIC® QUALITY CPR TRAINING MANIKIN CPRLILLY PRO+ MONITORS UP TO 10 TRAINEES AT A TIME AND COMPLIES WITH AHA'S 2019 REQUIREMENTS FOR DIRECT FEEDBACK



## CPRLilly PRO+ Prepare students for the real emergency

Performing CPR is tough, quickly strains energy and nerves. However, knowing what to do in an emergency can save the life of a friend, family member or a stranger.

The Quality CPR manikin offered by 3B Scientific enables instructors and healthcare providers to measure, monitor and analyze the CPR performance of up to 10 trainees at the same time. CPRLilly PRO+ helps instructors increase effectiveness and efficiency in their CPR courses by connecting with the CPRLilly App on tablet to follow the CPR performance and deliver objective feedback leading to Quality CPR training (App available on Apple and Android). It also enables trainees to see and monitor their own performance in real-time with the student view of the App. LED lights located directly on manikin's neck provide direct CPR feedback and indicate correct compression parameters (depth, release and rate).

The easy to use App lets the instructor and trainees review CPR performance in real-time. Trainee performance can be tested with the results being saved for further analysis and debriefing.

## › QUALITY CPR FEATURES FOR TRAINING AS REALISTIC AS POSSIBLE:



Head tilt and jaw thrust indicator



Lights indicate correct CPR performance



Palpable carotid pulse



### Quality CPR Feedback:

- + Compression depth
- + Compression rate
- + Compression fraction
- + Chest release
- + Jaw thrust and head tilt control
- + Correct hand placement
- + Appropriate ventilation volume

### Key Training Features:

- Quality CPR feedback with debriefing history
- Chest rise with proper ventilation
- Control of proper airway desobstruction
- AED pads placement training capable
- Constant analysis of CPR parameters for up to 10 manikins simultaneously
- Individual review possibility in group training for more efficient training
- Adaptable to different course concepts

### Solid manikin for effective training:

- Made in Germany of extremely durable, latex free material
- Face masks and lungs bags can be changed without tools
- Easy to clean with hygienic airway system
- Runs quietly and with efficient power usage
- Stable WiFi connection and intuitive app interface
- Dark skin manikin available

### Delivery content:

1 CPRLilly PRO+ training manikin, 1 tablet (depends on the model), 1 charger and battery, 4 lower face masks (including teeth), 25 throat bags, 12 AED-Pad adapters, carrying bag with training mat. 78 x 39 x 26 cm; 9,7 kg

**CPRLilly PRO+ with Tablet M-1022071**

**CPRLilly PRO+ without Tablet M-1022237**



*Instructor will at any time be able to access a detailed view on each trainees CPR-performance by a simple touch*



*Trainees will follow the CPR parameters on a simplified feedback view and improve their performance in real time*

Upgrade now and equip your courses with direct feedback CPR training manikins to comply with AHA's guidelines. CPRLilly PRO+ meets the requirements for direct feedback and Quality CPR in the AHA guidelines:

**“Instrumented directive feedback device measures compression rate, depth, hand position, recoil and chest compression fraction and provides real-time audio or visual feedback (or both) on these critical CPR skills.”**



*Instructor debriefs trainee about CPR performance*

Model shown: CPR Simon BLS Full Body Simulator with OMNI® Code Blue Pack M-1009220

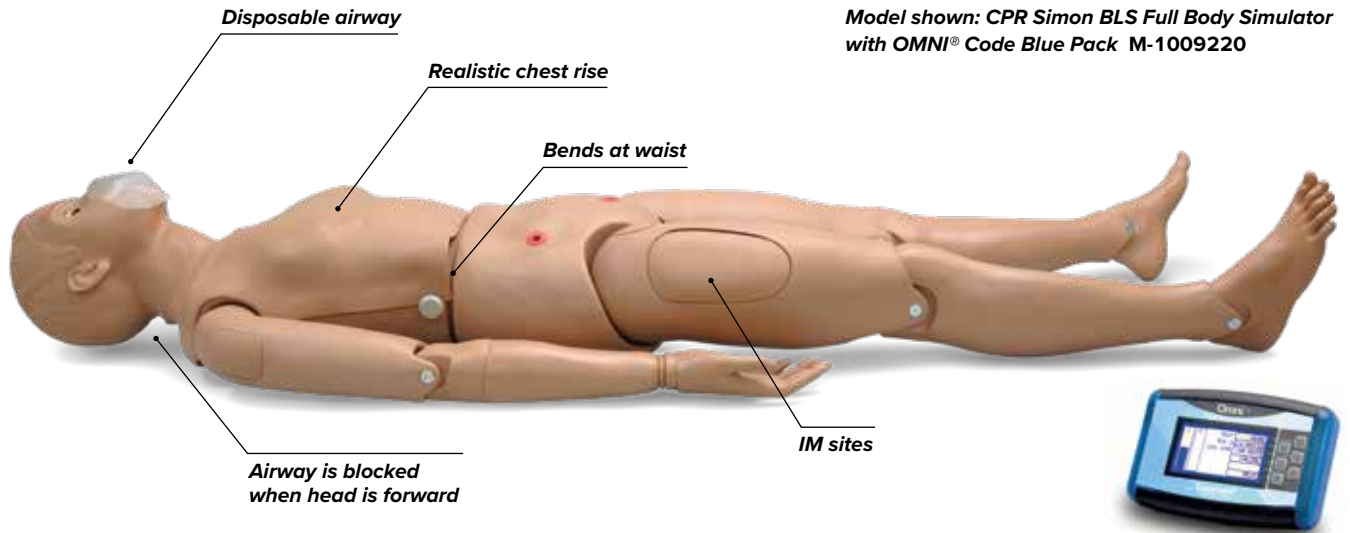

**CPR Simon BLS Full Body Simulator with OMNI® Code Blue Pack**  
Quality CPR simulator designed to operate for years! Strong, sturdy construction with full-size, realistic landmarks and one piece disposable airways. Omni® Code Blue pack included.

- Easily accessible chest cavity with ribcage, lungs, and heart for realism and practice of the Heimlich maneuver
- Realistic chest rise during ventilation
- Carotid, femoral arterial pulse sites
- Femoral venous site
- Intramuscular (IM) Injection Sites on the deltoids, quadriceps and left gluteus medius
- Jointed elbows, wrists, knees and ankles
- Eyes open and close; one pupil is dilated

**M-1009220**

**CPR Simon® BLS Full Body Simulator with Venous Sites**

This life size adult manikin is designed to provide the fundamentals of CPR instruction as well as numerous patient care exercises. All features of M-1009220 but without the Omni® Code Blue pack monitor and not prewired for CPRLink™. Comes with instruction manual and carrying bag.

**M-1017559**



**Disposable airway**



**Multiple pulse points**



**OMNI® Code Blue Pack**

Item no.	Simon® CPR Skills Trainer		Simon® CPR Patient Simulator	
	M-1005819	M-1022057	M-1017559	M-1009220
Torso / full-body	torso	torso	full-body	full-body
CPR	✓	✓	✓	✓
Disposable airway	✓	✓	✓	✓
Carotid pulse sites	✓	✓	✓	✓
OMNI® Code Blue pack	-	✓	-	✓
Femoral venous site	-	-	✓	✓
IM sites	-	-	✓	✓



**Code Blue® – Multipurpose Patient Simulator with OMNI®**  
**Provides practice in a wide range of CPR and patient care skills such as:**

- General care
- Gynaecological examination
- Airway management
- Breast examination
- Injection and infusion
- Colostomy and decubitus care

**Features:**

- Interchangeable external genital organs that allow both male and female catheterization
  - Interchangeable male and female breasts
  - Left female breast contains malignancy
  - It has fully movable neck, arms and legs, and the skin of face, vagina and cervix is soft for added realism
  - With anatomically accurate and intubatable airway
- Supplied with Omni® Code Blue Pack, 10 training masks, Code Blue® Life Monitoring System, neck brace and carrying bag.

**M-1017533**



**Code Blue® Multipurpose Simulator with Non-Intubatable Disposable Airway**

All features of M-1017533 but airway not intubatable. Supplied with Omni® Code Blue Pack, 10 disposable one-piece airways, neck brace, and carrying bag.

**M-1005782**



PLEASE SEE PAGES 102-108 FOR MORE PATIENT CARE SIMULATORS



**CPR Susie Advanced Emergency Care**

This life size adult manikin is designed to provide the fundamentals of CPR instruction as well as numerous patient care exercises such as intramuscular and subcutaneous injections, male and female catheterization, intubation, enema administration, decubitus treatment and palpation of right and left carotids.

**Other features include:**

- Neck brace
- Amputation stump
- Electronic CPR monitor
- Interchangeable male and female breasts (left female breast contains malignancy)

- Male/ Female
  - Movable jaw with removable upper and lower dentures
  - Oral, nasal, otic, tracheotomy, and gastrostomy openings for instruction in nasogastric
  - Lavage and gavage
  - Removable internal tanks
  - Sculpted stomas for transverse colostomy, ileostomy, and suprapubic stoma, each connected to an internal, removable tank
- Comes with instruction manual.

**M-1017543**



**CPR Metrix Control Box**

**Life/form® CPARLENE® Full-Size Manikin with CPR Metrix and iPad®**

This full-size manikin allows the practice of adult CPR techniques. Combined with CPR Metrix and Control Box (included), it offers a high-tech solution for CPR training and its documentation.

**Features:**

- Palpable anatomical landmarks (xiphoid, navel, nipples and ribcage)
- Enhanced student motivation through use of the optional SkillGuide indicator that allows real-time CPR performance feedback during training
- Adult CPR training with optional child springs
- Fully articulated head, neck and jaw
- Palpable carotid pulse
- Individual student face masks provide maximum protection against cross contamination

**CPR Metrix and iPad® is a high-tech solution for CPR training and documentation:**

- Graphical interfaces and audio feedback are easy for students to use and follow
- Solid documentation lets you easily track each student's performance
- Debriefing tools help with documentation and support training
- Detailed reports can be saved in PDF format

**M-1022171**



**Debriefing tools help with documentation and support training**

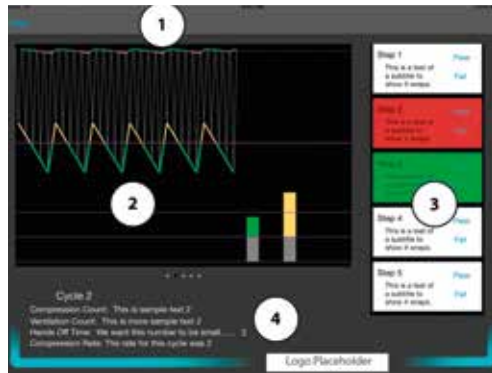

**Graphical interfaces and audio feedback are easy for students to use and follow**

Consumables and replacement parts	Item No.
Sanitary Face Masks	M-1005600
Disposable Tracheal Airways	M-1005601
Left Arm	M-1019765
Right Arm	M-1019766
Manikin Legs with Pants	M-1019768
Foam Neck Ring (4 pieces)	M-1019760
Torso Shell	M-1019762
Outer Chest Skin	M-1019763
Eye (dilated)	M-1019722
Eye (constricted)	M-1019723
Skull	M-1019756
Neck	M-1019757
Simulated Pulse	M-1019761





**Simulaids® Adult CPR Manikin with Electronics**

*This full-size manikin allows the training of BLS rescue techniques and CPR. The resiliency and weight of the body contribute to a realistic training experience:*

**Features:**

- Natural resistance to chest compression
- Palpable carotid pulse
- Anatomical landmarks such as sternum, ribcage and sub-sternal notch
- Airway ball valve which allows the lungs to inflate only if the head is extended and accurately positioned
- Light controller which confirms correct hand placement, ventilation volume and compression depth

165 cm; 24 kg

**M-1005738**

**Simulaids® Full-Body CPR Manikin**

This full-body CPR manikin with additional trauma options features life-like positioning, a carotid pulse, and anatomical landmarks that include the sternum, ribcage, and substernal notch. Caucasian appearance. Add trauma options in the table to the right as needed for additional training features. The manikin comes ready to go with a sweat suit, five mouthpieces and five airway systems with lungs.

**M-1018871**

Consumables and replacement parts	Item No.
Trauma Moulage Kit	M-1005712
IV Arm	M-1005749
Replacement Lungs	M-1019296
Rescue CPR Head	M-1020119
10 Adult Airway Systems	M-1005747
Carrying Bag	M-1005748
10 Mouth/Nose Pieces	M-1005741



**YOU CAN USE ANY OF THE MOULAGE AND WOUND SIMULATION KITS FROM PAGE 38 TO MAKE THE TRAINING EVEN MORE REALISTIC**

**Simulaids® Adam CPR™ Training Manikin with Electronics and Carry Bag**

*This lightweight and easy to transport torso features:*

- Airway ball valve which allows the lungs to inflate only if the head is extended and accurately positioned
- Life-like anatomical landmarks such as carotid pulse, sternum, ribcage and sub-sternal notch
- Light controller confirms correct hand placement, ventilation volume and compression
- Easy to replace mouth/nose pieces
- Soft carrying case with kneeling pads

70 cm; 8.4 kg

**M-1005726**

**Simulaids® Adam CPR™ Training Manikin (not shown)**

Same features as M-1005726 (above) but does not include the exterior console for assessment of the correct hand placement, adequate depth of compression and ventilation.

**M-1005725**



**Brad™ Compact CPR Training Manikins** are an economical CPR solution that prepares students for emergency situations which might happen in real life. Realistic head tilt and chin lift open the airway and can be easily manipulated to realistically simulate obstruction or choking situations. These lightweight, compact trainers come with reusable replacement parts as well as disposable lung and airway systems.

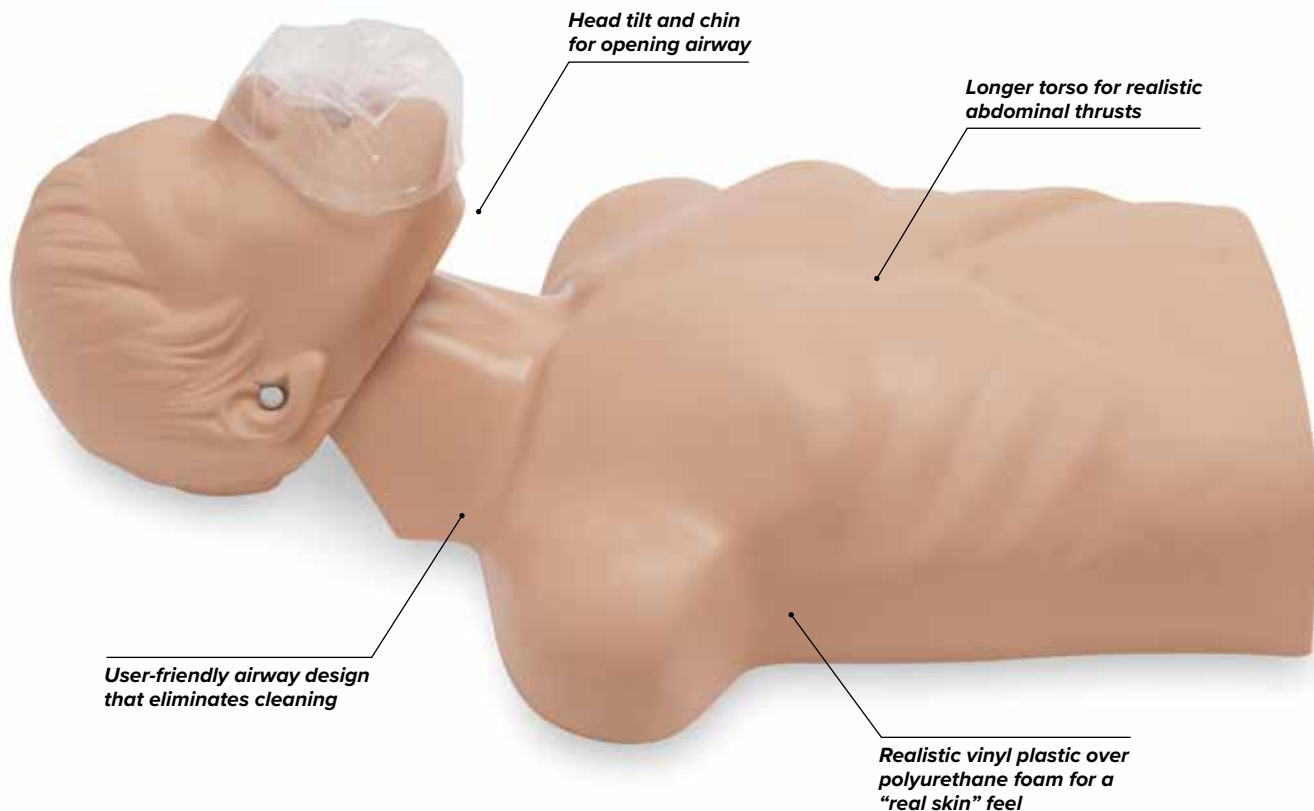

#### **Brad™ Compact CPR Training Manikin with Electronics**

This economical CPR manikin is constructed of soft, realistic vinyl plastic over polyurethane foam for a “human” feel. Comes with an exterior console box that indicates proper hand position, adequate chest compressions, and adequate air volume.

##### **Features:**

- Long torso for realistic abdominal thrusts
- Realistic head tilt and chin lift for opening airway
- Can easily be manipulated to realistically simulate airway obstruction or choking situations
- User-friendly, low maintenance lung/airway design

Includes 3 mouth/nose pieces, 3 disposable lung/airway systems, nylon carry bag and kneeling pads.

71 x 46 x 25 cm, 8 kg

**M-1009004**

#### **Brad™ Compact CPR Training Torso**

This economical CPR manikin is constructed of soft, vinyl plastic over polyurethane foam for a “human” feel. Includes 3 mouth/nose pieces, 3 disposable lung/airway systems, nylon carry bag and kneeling pads.

##### **Features:**

- Longer torso for realistic abdominal thrusts
- Realistic head tilt and chin lift for opening airway
- Easy to manipulate and realistically simulate airway obstruction or choking situations
- User-friendly, low maintenance lung/airway design

65 x 38 x 22 cm; 5.4 kg

**M-1005753**

#### **Jaw Thrust Brad™**

Jaw Thrust Brad utilizes simple moving-parts technology for the instruction of the jaw thrust maneuver. Unique to the industry is the function of ventilating the patient when the proper maneuver is done without tilting the head.

##### **Features:**

- Movable jaw
- Individual mouth piece
- Sanitary one-way bag allows multiple users while requiring a single replacement at end of day
- Removable chest plate for adolescent and adult CPR
- Rugged vinyl skin and long-lasting foam filling

Includes kneeling pads and carry bag.

71 x 46 x 25 cm, 8 kg

**M-1013162**

**ZOLL AED Trainer Package with CPR Brad™**

This unit allows students to practice realistic device operation using AHA recommended training scenarios. An identical graphical operator interface and complete audio and visual prompts mimic the AED Plus in its look and operation. Screen messages, audible tones, and voice prompts guide the user through all aspects of the rescue. The convenient handheld remote control for instructor use is pre-programmed with the eight AHA Heartsaver AED training scenarios and offers a manual scenario function, plus attach pads, low battery, and call-for-service simulations. Powered by six "C" cell batteries (not included) or an AC adaptor. Supplied with training electrode kit, training remote control, AC adaptor, handheld cord, operator manual, administration guide.

**M-1018859**



**Life/form® AED Trainer with Brad™ CPR Manikin**

Prepare students for emergency situations with the Life/form® Universal AED Trainer complete with Brad™ the CPR Manikin. Simply push a button to set the sequence of events that will help students learn the appropriate steps to follow in both "shock" and "no shock" situations. The instructor can select from four training scenarios for manual and hands-free training. Train for AHA scenarios with both audio and written prompts in English. Comes with reusable pads, electrode sets and operating instructions. Includes Brad™ CPR Manikin with 3 mouth/nose pieces, 3 disposable lung/airway systems, nylon carrying bag and kneeling pads.

**M-1018858**

**Zoll AED Trainer Plus 2**

Provides a variety of simulations to help responders become familiar with an AED device. The simulated shock delivery has no high-voltage capabilities, ensuring safety during training. It is pre-configured with 10 training scenarios that simulate realistic sudden cardiac arrest episodes and can be used with appropriate manikins. Software and manual are only available in English.

**M-1018143**





**“Airway Larry” Torso with Defibrillation Features, ECG Simulation, and AED Training**

The Life/form® Advanced “Airway Larry” Airway Management Trainer is now even better with chest skin that lets you practice defibrillation using standard manual, automatic, or semi-automatic external monitor defibrillators. An internal load box absorbs the full strength of every shock to protect students and equipment. The included interactive ECG simulator comes with 6 waveforms available for pacing and 17 Adult/Pediatric Rhythms.

**M-1018868**

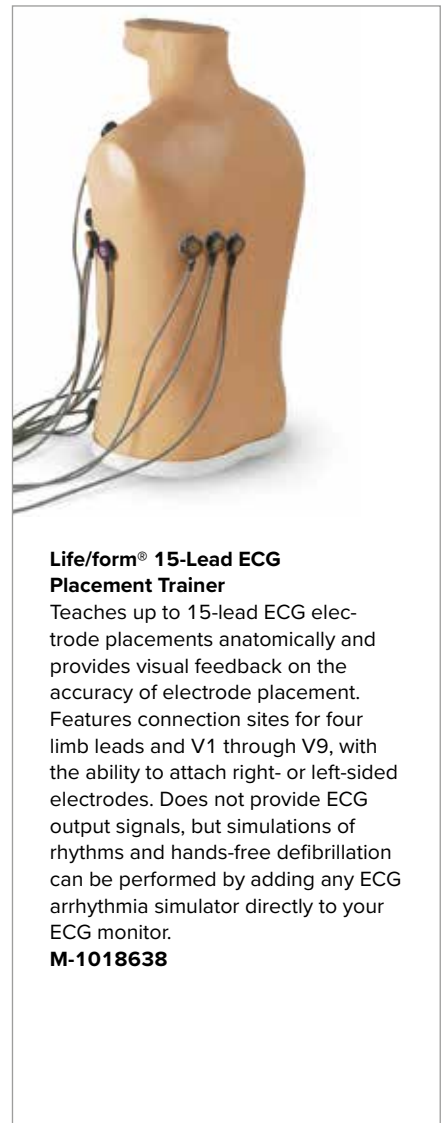

**Life/form® 15-Lead ECG Placement Trainer**

Teaches up to 15-lead ECG electrode placements anatomically and provides visual feedback on the accuracy of electrode placement. Features connection sites for four limb leads and V1 through V9, with the ability to attach right- or left-sided electrodes. Does not provide ECG output signals, but simulations of rhythms and hands-free defibrillation can be performed by adding any ECG arrhythmia simulator directly to your ECG monitor.

**M-1018638**

**ECG Training Vest**

The new ECG Training Vest offers an inexpensive way to communicate with a live patient while monitoring. Since the volunteer wears this vest there is no need to use a high fidelity simulator. Vest can be hooked up to the ECG Simulator. Includes the interactive ECG Simulator, contains no electrical energy and is not for defibrillation practice.

30.5 x 30.5 x 22.9 cm; 2.25 kg

**M-1017249**



**Simulaids® Choking Manikins**

Life-size torsos allow practice of abdominal/ chest thrust back blow procedures (Heimlich maneuver) and mouth sweep for clearing a blocked airway. When correct procedures are performed, the manikins will expel the object causing the obstruction. Made of durable vinyl to create realistic feel. Include anatomical landmarks such as ribcage, xiphoid process and jugular notch. Supplied with choking objects, shirt and soft carrying bag.

**Adult Choking Torso**

**M-1005724**

**Adolescent Choking Torso**

**M-1005750**

**Obese Adult Choking Torso**

**M-1005684**



**Child Choking Torso**

**M-1005751**



### Act+Fast Rescue Choking Vest

Invaluable tool for CPR instructors to easily and effectively teach students the correct way to perform the Abdominal Thrust maneuver (Heimlich) without using a manikin. When performed correctly, a foam plug shoots into the air, making teaching easy and learning fun. 10 foam plugs included.

**Act+Fast Blue**  
M-1017938

**Act+Fast Red**  
Features a Back Blow Pad for practicing ARC and ERC protocol.  
M-1014589



### Basic Buddy™ CPR Manikins

The one-piece, disposable lung/mouth protection system makes this manikin completely sanitary – there is no risk of cross contamination and no need to sanitize the manikins after use! Rugged carrying bags make transporting the lightweight Basic Buddy™ 5 and 10-Packs convenient (manikins fit into bags fully assembled).

**Life/form® Basic Buddy® Single CPR Manikin**  
1 manikin, 10 lung/mouth protection bags, 1 insertion tool, instruction manual.  
20 x 37 x 52 cm; 2.2 kg  
M-1005637

### Basic Buddy™ 5-Pack

5 manikins, 50 lung/mouth protection bags, 5 lung insertion tools, 1 carrying bag, instruction manual.  
6 kg  
M-1005636

### Basic Buddy™ 10-Pack

10 manikins, 100 lung/mouth protection bags, 2 carrying bags, 10 lung insertion tools, 2 instruction manuals.  
12 kg  
M-1005635

**5 Torso Carrying Bag**  
M-1005639



### TPAK 700 CPR Prompt® 7-Pack

Includes five adult/child manikins, two infant manikins, 50 adult/child face shield/lung bags, 20 infant face shield/lung bags and nylon carry case.

M-1017941

### CPR Prompt® Training and Practice Manikins-Adult/Child Manikin

Low cost, professional quality manikins ideal for group training! Comprehensive design allows for practice of Heimlich maneuver, CPR and mouth-to-mouth breathing. Realistic anatomical markings (Adam's apple, carotid arteries, navel, rib cage, chest notch) make it easy to learn correct hand placement for checking pulse, performing chest compressions, and more.

#### **Provides valuable student feedback and other important features:**

- Head tilt/chin lift required to open airway
  - Proper anatomical landmarks
  - Audible compression "clicker" to ensure proper technique
  - Age selector dial to adjusts chest compression piston for learning adult or child techniques
- Easy-to-clean heads are dishwasher safe and can easily be sanitized. Lung bags are replaceable. Includes a supply of face-shield lung bags, insertion tool, and assembly instructions.

M-1017939

### Adult/Child Manikin, 5-Pack

Includes carrying case.

M-1017940

### Infant Manikin, 5-Pack

Includes carrying case.

M-1017942

### Infant Manikin

M-1018141

# BASIC LIFE SUPPORT PEDIATRIC

## CPR-Torso Brad™ Junior with Electronics

Brad™ Junior's realistic appearance, accurate anatomical landmarks, and individual-use mouth/nose pieces with disposable airway/lung system and non-rebreathing valve combine for function, durability, and ease of use.

Includes a carrying bag. Approximate age: 7 years

**M-1018850**



## Mike® and Michelle® CPR and Trauma Care Simulator (5-year old)

This anatomically accurate representation of a school age child is a perfect training tool for basic life support such as CPR and trauma care.

### Some features:

- Fully articulating head and jaw with teeth and tongue
  - Individual disposable airways to practice hygienic mouth-to-mouth ventilation
  - Airway blocked when head is forward
  - Easily accessible chest cavity with molded rib cage, lungs, and heart
  - Realistic chest rise during ventilation
  - Carotid, femoral, and brachial arterial pulse sites
- Comes with T-shirt and shorts, custom nylon carrying bag, and instruction manual.

**M-1017539**



## ➤ FURTHER BASIC LIFE SUPPORT 5-7 YEAR OLD SIMULATORS ARE AVAILABLE



	Child CPR Torso	CPR Patient Simulator	CPR Patient Simulator with OMNI®	CPR and Trauma Care Simulator	CPR and Trauma Simulator with OMNI®	CPR-Torso Brad™ Junior with Electronics
Item no.	M-1005752	M-1013815	M-1020144	M-1022059	M-1017539	M-1018850
Age	5-year old	5-year old	5-year old	5-year old	5-year old	7-year old
Torso/full-body	torso	full-body	full-body	full-body	full-body	torso
CPR	✓	✓	✓	✓	✓	✓
Disposable airway	✓	✓	✓	✓	✓	✓
Arterial pulse sites	-	✓	✓	✓	✓	-
OMNI® Code Blue pack	-	-	✓	-	✓	electronics system with feedback
Intraosseous access	-	-	-	✓	✓	-
Femoral venous site	-	-	-	✓	✓	-
Feedback of hand position, compressions and ventilations	-	-	-	-	-	✓



**Pediatric One Year CPR and Trauma Care Simulator**

CPR and trauma care simulator with an automatically accurate representation of a 1-year old child. It is a superb training tool for pediatric basic life support. The upper torso of the simulator has life-size lungs, heart and ribcage, molded in soft vinyl. The anatomy provides a realistic experience when practicing cardiopulmonary resuscitation.

**Features:**

- Fully articulating head and jaw with teeth and tongue
- Individual disposable airways
- Airway blocked when head is forward
- Easily accessible chest cavity with molded ribcage, lungs and heart
- Realistic chest rise
- Four arterial pulse points

Comes with exercise suit, custom nylon carrying bag, and instruction manual.

**M-1017541**

**Pediatric CPR Manikins-Child Manikin (3-year old)**

Economically priced manikins for teaching CPR. The lightweight, rugged, realistic manikin is foam-filled with no internal parts to break. Completely disposable airway system with a uni-directional valves. Life-like anatomical landmarks such as nipples, xiphoid process and sub-sternal notch.

82 x 24 x 15 cm, 4.1 kg

**M-1005733**

➤ FURTHER BASIC LIFE SUPPORT 1-3 YEAR OLD SIMULATORS ARE AVAILABLE



	Kim™ CPR Manikin	Kevin™ CPR Manikin	Pediatric Care Simulator	Pediatric Care Simulator with OMNI®	CPR Patient Simulator with OMNI®	Kyle™ CPR Manikin
Item no.	M-1005728	M-1005731	M-1017541	M-1020145	M-1020115	M-1005733
Age	newborn	6-9 months old	1-year old	1-year old	1-year old	3-year old
CPR	✓	✓	✓	✓	✓	✓
Disposable airway	✓	✓	✓	✓	✓	✓
Arterial pulse sites	-	-	✓	✓	✓	-
OMNI® Code Blue pack	-	-	-	✓	✓	-
Intraosseous access	-	-	-	-	✓	-
Femoral venous site	-	-	-	-	✓	-
Carrying bag	✓	✓	-	-	-	✓



PLEASE VISIT [3BSCIENTIFIC.COM](http://3BSCIENTIFIC.COM) TO FIND OUT MORE ABOUT PRODUCTS FEATURED IN THESE TABLES



**PEDI® and Mike® & Michelle®** simulate a 1-year old and are another must for a well-equipped training program. These full-body manikins with articulating joints and soft, life-like skin have CPR capabilities via head tilt and chin lift. Airway management procedures such as oral/nasal nasogastric intubation or gastric suctioning can be also exercised. Intramuscular injection sites, lavage/gavage or simulated ear canal are only a few of their features – please take a look at the table below to see what else they can offer.

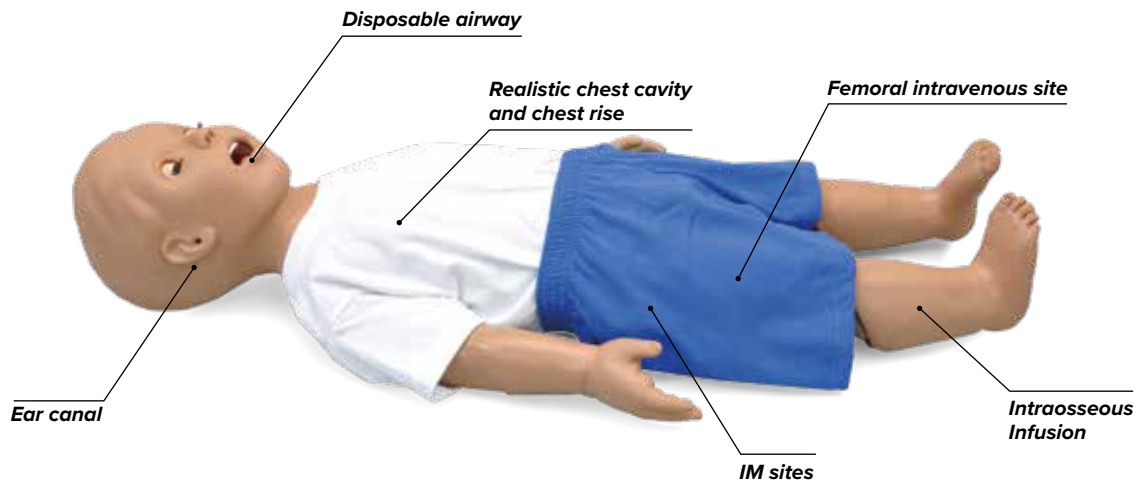

➤ PLEASE TAKE A LOOK AT THE BELOW TABLE TO FIND A 1-YEAR OLD PEDIATRIC SIMULATOR THAT BEST FITS YOUR REQUIREMENTS

	Multipurpose Patient Simulator	PEDI® Nursing Care Patient Simulator	Mike® and Michelle® Pediatric Care Simulator
Item no.	M-1014623	M-1022063	M-1005804
Age	1-year old	1-year old	1-year old
CPR anatomical landmarks and realistic internal organs	✓	✓	-
Chest rise	✓	✓	-
Femoral vein and brachial pulse	✓	✓	-
Popliteal pulse	✓	-	-
Oral/Nasal endotracheal intubation	✓	✓	-
IO and IV arm	✓	✓	-
Stomas for Ileostomy, colostomy, and suprapubic exercises	✓	-	-
Interchangeable genitalia and catheterization	✓	-	✓
Tracheostomy care and G-tube placement	✓	-	✓
Enema administration	✓	-	✓
Placement of rectal suppositories	✓	-	-
Carrying bag	included	included	included



### Sani-Baby CPR Manikin

This economical, baby-size manikin has a disposable, sanitary, single-user lung/airway and face shield system: no cleaning, disinfecting or disassembly necessary. Sani-Baby features a realistic face, moulded hair, and xiphoid process, as well as a realistic chest rise and anatomical landmarks such as sternum, ribcage and sub-sternal notch. 66 x 20 x 20 cm; 1.1 kg

**M-1005745**

#### Consumables and replacement parts:

**10 Mouth/Nose Pieces**

**M-1018326**

**100 Airway/Lung/Face Shield Systems**

**M-1005746**

**Carrying Bag**

**M-1005744**



### CPR Cathy™ Infant Manikin with Electronics for Direct Feedback

The infant manikin can be filled with water to approximate the same weight and “feel” as a real child of corresponding size. Realistic chest rise, and other features like life-like ribcage, sternum, xiphoid process, and suprasternal notch help train effective compression techniques. The trouble-free electronics housed outside of the manikin can be used to monitor correct performance during CPR training. Sensors activate lights and/or an audio signal to indicate correct lung ventilation, depth of compression, and correct finger or hand placement. Includes carrying bag and 12 disposable lungs.

66 x 20 x 20 cm; 2.7 kg

**M-1017247**

### Infant Choking Manikin

Train the challenges associated with foreign body obstruction in the young pediatric age group with this 9-month-old baby manikin. By placing the included obstruction in the pharyngeal cavity, you will occlude the throat and initialize the need for protocol maneuver to remove the object. When proper hand placement occurs with sufficient force, the object expels from the mouth.

**M-1005778**

#### Consumables and replacement parts:

**Pocket Mask**

**M-1018855**

**AED Trainer Plus 2**

**M-1018143**



**MORE CHOKING MANIKINS ON PAGE 60**

# AIRWAY MANAGEMENT

## ADULT

Model shown: **HAL® Adult Airway and CPR Trainer M-1019855**  
with **OMNI® Code Blue pack M-1020211**



### HAL® CPR+D Trainer with Advanced Feedback

Stores the energy generated by chest compressions for power. Without the use of batteries or power cords, the trainer is capable of recording CPR quality and performance metrics, presenting realistic chest rise and palpable pulses after resuscitation, and more. Take your training to more places and reach more people with the convenience of truly tetherless technology.

#### Features:

- Intubatable airway with tongue, vocal cords, and trachea
  - Realistic head tilt/chin lift and jaw thrust
  - Realistic chest cavity allows students to experience the correct force needed to perform proper chest compressions
  - Anatomically correct landmarks for proper hand placement
  - Proper chest compressions
  - Defibrillation: Attach real AED pads directly to the conductive skin
  - Shock the conductive skin using your defibrillator just like a real patient
  - Your AED will display the simulator's ECG
  - Automatic pulses and breathing with realistic chest rise
- Comes with handheld controller with 4.5 m cable, carrying bag and operating guide.

**M-1018867**

### HAL® Adult Airway and CPR Trainer

The perfect trainer for practicing fundamental intubation and CPR skills. Features a life-like airway and a durable chest recoil system. It is CPR and Omni® Code Blue Pack (M-1020211) compatible, thus capable of providing real-time CPR quality feedback and reporting.

- Nasal and oral Intubation: ETT, LMA, King LT®
- Gastric distension with oesophageal intubation
- Nasal passage permits placement of NP tube

**M-1019855**

### HAL® Adult Multipurpose Airway and CPR Trainer

Train participants to recognize laryngospasm and if needed, perform an emergency tracheostomy or cricothyrotomy. To improve CPR training, add the OMNI® Code Blue® Pack option to view real-time CPR quality feedback via the handheld OMNI controller and PC link software.

- Laryngospasm
- Tracheostomy and cricothyrotomy
- Nasal and oral Intubation: ETT, LMA, King LT®
- Right mainstem intubation presents unilateral chest rise
- Gastric distension with oesophageal intubation

**M-1019856**



Anterior heart and lung sounds



Posterior lung sounds



**Defibrillation**



**Intubation**



**Head tilt**



**Tracheostomy**

**> PLEASE TAKE A LOOK AT THE TABLE BELOW TO FIND A HAL® SIMULATOR THAT BEST FITS YOUR REQUIREMENTS**

	HAL® Adult Airway and CPR Trainer	HAL® Adult Multi-purpose Airway and CPR Trainer	HAL® Airway, CPR, and Auscultation Skills Trainer	HAL® Adult Multi-purpose Airway and CPR Trainer	HAL® CPR+D Trainer with advanced feedback
Item no.	M-1019855	M-1019856	M-1022061	M-1022062	M-1018867
Manually open or close eyes	✓	✓	✓	✓	✓
Realistic head tilt/chin lift and jaw thrust	✓	✓	✓	✓	✓
CPR hand positioning landmarks	✓	✓	✓	✓	✓
Chest compressions generate palpable carotid pulses	manual	manual	manual	-	manual
Spontaneous breathing	-	-	-	-	✓
Chest rise	✓	✓	✓	✓	✓
Stomach rise	✓	✓	✓	✓	-
Nasal and oral intubation – ETT, LMA, King LT®	✓	✓	✓	✓	✓
Right mainstem intubation presents unilateral chest rise	✓	✓	✓	✓	✓
Tongue edema	-	-	-	✓	-
Laryngospasm	-	✓	-	✓	-
Pharyngeal	-	-	-	✓	-
Tracheostomy and cricothyrotomy	-	✓	-	✓	-
Bilateral chest tube sites at fifth intercostal space	-	-	-	✓	-
Bilateral needle decompression site at second intercostal space with audible hiss	-	-	-	✓	-
Programmable heart and lung sounds	-	-	✓	-	-
Detectable EKG rhythm using real AED	-	-	-	-	✓
Defibrillate and cardiovert using real energy	-	-	-	-	✓
Carrying bag	included	included	included	included	included

**TruCorp® Adult Intubation Manikins** feature the innovative AirSim® airway and nasal cavity, which has been created based on DT DICOM data. These premium, state of the art intubation trainers have anatomically and visually correct landmarks in airway and nasal passage. There is realistic feedback during airway management procedures, and all manikins features a “real feel” skin with a life-like texture to make the simulation even more realistic.

**AirSim®**

The AirSim® contains the key features of the AirSim Standard Model with the addition of a nasal passage and a chin. The AirSim Multi Model facilitates training on nasal procedures as well as bag and mask ventilation techniques. The nasal passage has been developed in a manner similar to the main airway. This gives the same anatomical realism and functionality, important landmarks such as the turbinates are clearly defined. In addition, the material used offers the same tactile feedback which is delivered with the main airway itself.

**M-1015519**



**AirSim® Advance X**

The AirSim® Advanced Model features the uniquely constructed AirSim airway designed to provide true, anatomically correct and visually accurate internal features. The addition of a “real-feel” skin covering provides a more realistic bag mask ventilation training experience.

**Features:**

- Improved neck design allowing for accurate articulation
- Anatomically accurate nasal passage
- Inflatable tongue to increase difficulty of airway
- Option to include “breakout teeth” to simulate the effects of bad practice in laryngoscopy

46 x 26 x 33 cm; 3.05 kg

**M-1015527**



**AirSim® Bronchi**

The AirSim® Bronchi is the latest product addition to the AirSim family, providing anatomically correct detail down to the fourth generation bronchi. The AirSim® Bronchi provides exceptional detail in both internal and external features; made possible through a combination of cutting edge moulding technology and carefully handcrafted processes.

**The AirSim® Bronchi unit will provide a solution to your training needs in:**

- Diagnostic bronchoscopy
- Lung isolation techniques using left and right endobronchial tubes and bronchial blockers
- Lung suctioning techniques

46 x 26 x 33 cm; 3.05 kg

**M-1015523**





**Anatomically correct internal features**



**Innovative AirSim® airway and nasal cavity**



**Replaceable lung bags inflate with successful ventilation**



**Perfect for advanced airway management training**



**Needle cricothyrotomy**



**Bag valve mask ventilation**

➤ PLEASE TAKE A LOOK AT THE BELOW TABLE TO FIND AN ADULT AIRSIM® INTUBATION TRAINER THAT BEST FITS YOUR REQUIREMENTS

	AirSim®	AirSim® Advance X	AirSim® Bronchi	AirSim® Advance Bronchi X	AirSim® Combo X	AirSim® Combo Bronchi X
Item no.	M-1015519	M-1015527	M-1015523	M-1015530	M-1021921	M-1021550
5-year warranty	-	✓	-	✓	✓	✓
Needle and surgical cricothyroidotomy	-	-	-	-	✓	✓
Percutaneous tracheostomy	-	-	-	-	✓	✓
Fibre optic bronchoscopy techniques	-	-	✓	✓	-	✓
Lung isolation techniques	✓	✓	✓	✓	✓	✓
Lung suctioning	✓	✓	✓	✓	✓	✓
Diagnostic bronchoscopy	-	-	✓	✓	-	✓
Direct and video laryngoscopy	✓	✓	✓	✓	✓	✓
Endo and naso tracheal tube insertion	✓	✓	✓	✓	✓	✓
Supraglottic device insertion	✓	✓	✓	✓	✓	✓
Bag mask ventilation	-	✓	-	✓	✓	✓
Bronchial blocker insertion and specialised stents	-	-	✓	✓	-	✓



PLEASE VISIT [3BScientific.com](http://3BScientific.com) FOR A FULL LIST OF AVAILABLE CONSUMABLES AND REPLACEMENT PARTS



**Airway Larry® Airway Management Trainers** simulate a non-anesthetized patient for practicing intubation, ventilation, suction and CPR techniques. They have realistic anatomy and landmarks including teeth, tongue, oral and nasal pharynx, larynx, epiglottis, arytenoids, false cords, true vocal cords, trachea, lungs, esophagus, and stomach. Choose one of those great value for money trainers and present your students with the challenges they may face in the real world.



**Adult Airway Management Trainer**

The detailed anatomy provides a clear picture for intubation training: sculpted alveolar sac, bronchial tree, blood vessel structures of the cross-sectioned and exposed flexible lungs, interior main bronchus and oral/nasal pharyngeal spaces. Combine these with an airway complicated by breakout teeth, tongue edema, and laryngospasm, and this airway trainer really stands out. The stomach swells with oesophageal intubation, or excessive pressure with the BVM during rescue breathing and it also has the capability of vomiting.  
32 x 24 x 12 cm; 18.65 kg  
**M-1005774**

**Life/form® “Airway Larry” Adult Airway Management Trainer on Baseboard**

This trainer simulates a non-anaesthetised patient. Train the following procedures: Oral, digital, and nasal intubation E.T., E.O.A., P.T.L., L.M.A., E.G.T.A., and Combitube® insertion, Sellick maneuver, ventilation, CPR, suction techniques, and proper cuff inflation can all be practiced and evaluated. Comes with a training stand to mount.  
63 x 30.5 x 40.6 cm; 15.1 kg  
**M-1005633**



**▶ PLEASE TAKE A LOOK AT THE TABLE BELOW TO FIND AN AIRWAY MANAGEMENT TRAINER THAT BEST FITS YOUR REQUIREMENTS**

	<b>Adult Airway Management Trainer Head</b>	<b>Advanced Trainer Head</b>	<b>Adult Airway Management Trainer</b>	<b>Economy Adult Airway Management Trainer</b>
<b>Item no.</b>	<b>M-1012740</b>	<b>M-1020961</b>	<b>M-1005633</b>	<b>M-1005780</b>
<b>Head/torso</b>	male head	male head mounted on a board	male head mounted on a board	male head mounted on a board
<b>Ideal for</b>	introductory classes	introductory and advanced classes	testing purposes and Combitube® practice	rescue & advanced airway management training
<b>Oral and nasal intubation</b>	✓	✓	✓	✓
<b>Digital intubation</b>	✓	✓	✓	-
<b>Laryngospasm &amp; Tonge edema</b>	-	✓	-	-
<b>Breakout teeth</b>	-	-	-	-
<b>Ventilation</b>	✓	-	✓	-
<b>Stomach rise</b>	-	✓	-	-
<b>Suctioning</b>	✓	✓	✓	✓
<b>Jaw thrust</b>	-	-	✓	-
<b>CPR</b>	✓	-	-	-
<b>Manual carotid pulse</b>	✓	-	-	-
<b>Sellick maneuver</b>	✓	✓	✓	-
<b>E.T., E.O.A., P.T.L, L.M.A., Combitube®, and King System insertion</b>	✓	✓	✓	only LMAs and Combitube®
<b>Carrying bag</b>	-	-	included	✓
<b>Additional features</b>	can be attached to any of the adult CRiSis® Manikins	can be attached to any of the adult CRiSis® Manikins	can be attached to any of the adult CRiSis® Manikins	durable construction and bifurcated lung





**Life/form® S.A.L.A.D. Simulator**

- Suction Assisted Laryngoscopy and Airway Decontamination (S.A.L.A.D.) simulator uses suction to enhance first pass success-laryngoscopy (FPS-L) with a non-anesthetized patient in active emesis
- Offers room to maneuver and a slightly anterior position, making the simulator great for introductory classes as well as advanced students
- Apply cricoid pressure to change the position of the trachea and close the esophagus
- Rigid suction catheter distracts lower mandible and tongue to permit laryngoscope insertion

**M-1021583**



**Adult Deluxe Airway Management Trainer**

The life-like feel and an anatomy emphasizing accurate visualization features makes this trainer the choice for advanced airway management with the convenience of board mounting. Features include laryngospasm and tongue edema. Both air bags for lungs and stomach are visible for easy determination of successful intubation. All the anatomical landmarks are shown and the vocal cords are highlighted for easy viewing. The upper teeth break out if inappropriate technique is applied during intubations. Board is anchored to surfaces by suction cup feet. Delivery with soft carry bag, lubricant and instructions for use.

**M-1018851**



**PLEASE VISIT 3BSCIENTIFIC.COM TO FIND OUT MORE ABOUT PRODUCTS FEATURED IN IN THIS TABLE**

Adult Airway Management Trainer Head	Advanced Trainer Head	S.A.L.A.D. Simulator	Airway Management Trainer	Adult Deluxe Airway Management Trainer	Adult Airway Management Trainer
M-1017871	M-1019249	M-1021583	M-1019928	M-1018851	M-1005774
torso with a female head	male head mounted on a board	male head	male torso	male head mounted on a board	male torso mounted on a board
difficult airway and CPR training	advanced airway management training	suction assisted laryngoscopy and airway decontamination	airway management and CPR training	cricothyrotomy and advanced airway management	rescue airway and anatomy training
✓	✓	✓	✓	✓	✓
✓	✓	✓	✓	-	-
-	✓	-	-	✓	✓
-	-	-	-	✓	✓
✓	✓	-	✓	✓	✓
-	-	-	-	✓	✓
✓	✓	✓	✓	-	-
✓	-	-	-	-	-
✓	-	-	✓	-	-
✓	✓	✓	✓	-	-
-	✓	✓	-	-	-
✓	✓	✓	✓	-	-
-	included	included	-	-	included
durable construction and bifurcated lung	durable construction and bifurcated lung	rigid suction catheter distracts lower mandible and tongue to permit laryngoscope insertion	durable construction and bifurcated lung	life-like skin that will not be damaged by aggressive intubation	review of the pulmonary system and oral/nasal pharyngeal spaces



# AIRWAY MANAGEMENT

## CHILD

**AirSim® Pediatric Airway Trainers** feature the innovative pediatric AirSim® airway and nasal cavity, which has been created based on DT DICOM data. These premium, state of the art intubation trainers have anatomically and visually correct landmarks in airway and nasal passage. There is realistic feedback during airway management procedures, and all manikins features a “real feel” skin with a life-like texture to make the simulation even more realistic.

### **AirSim® Child Combo Bronchi X**

- Wraparound replaceable neck skin rotates for up to 20 incisions
- Easy identification of sternal notch, tracheal rings and cricoid and laryngeal cartilages
- Inflatable tongue with life-like texture can simulate edema
- Replaceable lung bags inflate with successful ventilation
- Optional subcutaneous fat tissue demonstrates more difficult tracheostomy and cricothyroidotomy procedures

**M-1021903**



### **AirSim® Child Bronchi X**

- AirSim® pediatric airway and nasal passage
- Bronchi accurate down to the fourth generation to facilitate full range of bronchoscopy techniques
- True to life external and internal anatomical features for clear demonstration of video laryngoscopy
- Inflatable tongue simulates edema for advanced practice
- Missing front teeth resemble actual dentals of a six year old child

**M-1021897**



### **AirSim® Baby X**

Features realistic anatomy and a clinical functionality that enables basic and advanced pediatric airway management. AirSim Baby facilitates training in the use of bag/mask ventilation, supraglottic airway insertion and both naso and orotracheal intubation. In addition, it can be used with all current video laryngoscopes. Realistic airway allows for training in all aspects of infant airway management including positive pressure ventilation, insertion of laryngeal masks and endotracheal intubations (nasal and oral).

**M-1015536**



### **AirSim® Pierre Robin X**

- Accurate representation of a pediatric patient with Pierre Robin Sequence
- Ideal for practicing airway obstruction management techniques
- Provides realistic feedback during airway management and laryngoscopy practice

**M-1021892**







*Innovative pediatric AirSim® airway and nasal cavity*



*Replaceable lung bags inflate with successful ventilation*



*Wraparound replaceable neck skin rotates for up to 20 incisions*



*Clinical functionality that enables basic and advanced pediatric airway management*



*Easy identification of anatomical landmarks*



*Silicone skin covering with life-like texture*

**▶ PLEASE TAKE A LOOK AT THE BELOW TABLE TO FIND A PEDIATRIC AIRSIM® INTUBATION TRAINER THAT BEST FITS YOUR REQUIREMENTS**

	AirSim® Baby X	AirSim® Pierre Robin X	AirSim® Child Combo X	AirSim® Child Combo Bronchi X	AirSim® Child Bronchi X
Item no.	M-1015536	M-1021892	M-1021904	M-1021903	M-1021897
5-year warranty	✓	✓	✓	✓	✓
Age	6-month old	6-month old	6-year old	6-year old	6-year old
Direct and video laryngoscopy	✓	✓	✓	✓	✓
Oral and nasal intubation techniques	✓	✓	✓	✓	✓
Double lumen endotracheal tube insertion	✓	✓	✓	✓	✓
Combi tube insertion	✓	✓	✓	✓	✓
Bag mask ventilation	✓	✓	✓	✓	✓
Laryngeal mask airway	✓	✓	✓	✓	✓
Fibre optic intubation	✓	✓	✓	✓	✓
Diagnostic bronchoscopy	-	-	-	✓	✓
Lung isolation techniques using left and right endobronchial tubes and bronchial blockers	✓	✓	✓	✓	✓
Supraglottic device insertion	✓	✓	✓	✓	✓
Lung suctioning	✓	✓	✓	✓	✓
Needle and surgical cricothyroidotomy	-	-	✓	✓	-
Percutaneous tracheostomy	-	-	✓	✓	-

These airway trainers are perfect for practicing basic to advanced **airway management skills on pediatric patients**. They simulate a 1- to 5-year old for training intubation, ventilation, suction and CPR techniques. They have realistic anatomy and landmarks including mouth, tongue, oral pharynx, larynx, epiglottis, vocal cords, trachea and esophagus. Choose one of those great value for money trainers and present your students with the challenges they may face in the real world.

 PLEASE VISIT [3BSCIENTIFIC.COM](http://3BSCIENTIFIC.COM) TO FIND OUT MORE ABOUT PRODUCTS FEATURED IN THIS TABLE

**Airway Trainer (1-year old)**

Skill training designed to present the same challenges experienced by paramedics and physicians in the real world with very young patients.

- Realistic chest cavity containing realistic organs
- Fully articulating head, neck and jaw permitting head-tilt/chin lift, jaw thrust and neck extension into the sniffing position
- Soft neck with cricocartilage permits classic Sellick maneuver
- Realistic trachea, bronchi and lungs. Observable bilateral lung expansion under positive pressure ventilation
- Airway narrows below vocal cords (realistic with “fish-eye” appearance)
- Airway diameter

**M-1018863**



➤ PLEASE TAKE A LOOK AT THE TABLE BELOW TO FIND A PEDIATRIC AIRWAY TRAINER THAT BEST FITS YOUR REQUIREMENTS

	NG Tube Insertion Trainer	Infant Airway Simulator	Infant Airway Trainer	Infant Intubation Head	Advanced Infant Intubation Head
<b>Item no.</b>	<b>M-1017250</b>	<b>M-1018863</b>	<b>M-1017954</b>	<b>M-1017245</b>	<b>M-1017236</b>
<b>Head/torso</b>	head mounted on a board	full-body	head mounted on a board	head mounted on a board	head mounted on a board
<b>Age</b>	1-year old	1-year old	1-year old	1-year old	1-year old
<b>Oral and nasal intubation</b>	-	✓	✓	✓	✓
<b>Digital intubation</b>	-	-	-	-	-
<b>Tongue edema</b>	-	-	-	-	✓
<b>Laryngospasm</b>	-	-	-	-	-
<b>Stomach rise</b>	✓	-	✓	-	✓
<b>Suctioning</b>	-	✓	✓	✓	✓
<b>Jaw thrust</b>	-	✓	-	-	-
<b>CPR</b>	-	-	-	-	-
<b>Manual carotid pulse</b>	-	-	-	-	-
<b>Defibrillation</b>	-	-	-	-	-
<b>Carrying bag</b>	-	included	included	included	-

<b>Additional features</b>	trainer for instruction of nasogastric tube insertion and care	chest cavity containing realistic organs, nasal passage permits placement of NP tube	accepts 4.0 mm endotracheal tubes	accepts 2.5 mm endotracheal tubes	Vocal cords are highlighted for easy viewing
----------------------------	--	--	-----------------------------------	-----------------------------------	--



**Advanced Infant Intubation Head with Board**

This station trainer incorporates new skin technology. The new material eliminates tearing of the airway, caused by beginning student intubation attempts. New tear-resistant material especially for beginners. Translucent property allows for life-like illumination of the airway and neck as the skill is attempted. Vocal cords are highlighted for easy viewing, the tongue swells, and all the anatomical landmarks are present.

38.1 x 25.4 x 20.3 cm; 4.08 kg  
**M-1017236**



**Child Airway Management Trainer Head with Lungs and Stomach**

A simulated head of a 5-year-old child featuring realistic size and anatomy. Perfect for practicing airway management skills on pediatric patients. Realistic anatomy, practice suctioning and oral, nasal, and intubation techniques. Separate lungs (M-1005652) can be added for auscultation.

Can be attached to any Life/form® Child Airway Management Trainer or Child CRiSis™ Manikin. Pump spray lubricant included. Manual carotid pulse.  
**M-1019788**



**Advanced Child CPR/Airway Management Torso with Defibrillation**

This Life/form® advanced airway management trainer with tongue swelling and laryngospasm is perfect for practicing skills on pediatric patients and represents the size of an 5-year-old patient.

- Realistic anatomy and landmarks include teeth, tongue, oral and nasal pharynx, larynx, epiglottis, arytenoids, false and true vocal cords, trachea, lungs, oesophagus, and inflatable stomach bladder to indicate oesophageal insufflation
- Practise defibrillation using standard manual, automatic, or semi-automatic external monitor defibrillators

**M-1018864**

Airway Management Trainer	Advanced Child Airway Management Trainer	Child Airway Management Trainer Head	Advanced Child Airway Management Trainer	Basic Child CPR/Airway Management Torso™	Advanced Child CPR/Airway Management Torso
M-1014201	M-1019787	M-1019788	M-1005698	M-1018865	M-1018864
head mounted on a board	head	head	head mounted on a board	torso	torso
3-year old	5-year old	5-year old	5-year old	5-year old	5-year old
✓	✓	✓	✓	✓	✓
-	-	-	✓	-	✓
-	✓	-	✓	-	✓
-	✓	-	✓	-	✓
-	-	✓	✓	-	✓
✓	✓	✓	✓	-	✓
-	-	-	✓	-	✓
-	-	-	-	✓	✓
-	✓	✓	✓	-	✓
-	-	-	-	-	✓
included	-	-	included	-	-
accepts 4.0 mm endotracheal tubes	can be attached to any of the Life/form® Child Airway Management Trainers or Child CRiSis Manikins	can be attached to any of the Life/form® Child Airway Management Trainers or Child CRiSis Manikins	also allows for E.T., E.O.A., P.T.L., L.M.A., E.G.T.A., Combitube®, and King System insertion	This torso is the foundation of the Child CRiSis™ system as arms, legs, and a defibrillation chest can be added later.	also allows for E.T., E.O.A., P.T.L., L.M.A., E.G.T.A., Combitube®, and King System insertion

# OBSTETRICS

► SIMULATE HIGH-STRESS BIRTHING SCENARIOS WITH THE AWARD-WINNING SIMone™



## SIMone™

### Birthing Simulator for advanced training with 14 cases

**Train realistic and interactive high-stress scenarios for vacuum and forceps delivery:**

- Haptic response technology
- Visual and audio interface
- Full debrief for optimal learning effect
- Multi-dimensional learning techniques are combined to assure a maximum effect!

The haptic response technology assures realistic training of motoric skills by combining the simulated scenario with high tech sensors: any movement or force that is being used throughout the procedure is measured and direct feedback tells the student the impact it has on the baby.

**With SIMone™, your medical staff can be trained in:**

- Correct use of instruments in assisted vaginal delivery
- Defining the position of the fetal head in relation to the maternal pelvis
- Management of birth complications by means of anamnesis, findings and interventions

#### **About the birthing simulator**

The simulator presents the haptics required in order to perform the instrument assisted delivery in the correct manner: presentation data, placement of the forceps and extraction, taking care of the head of the infant and the maternal soft tissue. The monitoring software provides information in response to the manipulation of the fetal head in the context of force-feedback. Realistic speed and resistance are simulated during delivery.

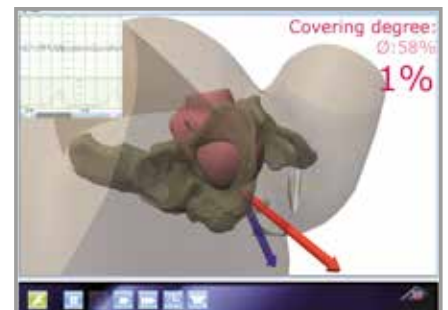

► DESIGNED AND MANUFACTURED IN GERMANY





## › Effective Training with SIMone™

SIMone™ has a patented force feedback mechanism that allows the trainee to confidently learn and develop the skills necessary for performing complicated procedures. SIMone™ gives the opportunity to practice an instrumental delivery in a realistic manner – over and over again with little or no setup time! In less than 60 seconds, a new birthing scenario can be initiated.

### **SIMone™ also trains students in:**

- Recognizing the right moment to select a vaginal assisted delivery
- Correct handling of medical instruments for delivery
- Assessing position of fetal head in relation to the maternal pelvis
- Labor management using a partogram
- Medication administration to achieve progress during delivery
- Interpreting fetal heartbeat and uterine contraction through a CTG
- Interpreting respiratory sounds
- Interpreting the sounds of pain experienced by the mother

### **Train the diagnosis, management and medical interventions for these 14 realistic birthing scenarios:**

- Multipara (normal birth)
- Nullipara (normal birth)
- Hyperactive labor
- Labor dystocia
- Intrauterine asphyxia
- Fever complications
- Infection complications
- Heavy Infection complications
- Mild preeclampsia
- Severe preeclampsia
- HELLP syndrome
- Overdue birth: mother refuses the labor induction procedure
- Overdue birth: mother accepts the labor induction procedure
- Overdue birth: post cesarean section, mother refuses a new cesarean section and the labor is induced

**M-1019599**



**Easy to clean genital insert**



**Forceps delivery**



**Vacuum-assisted delivery**

### **Examples of interventions and findings:**



**Body Temperature**



**Blood Pressure**



**Laboratory Values**



**Amniotic Fluid Quantity**



**Urine Screening Test**



**Fetometry**



**Placenta Examination**



**Ask the Patient Questions**



**Send Patient Home**

### **Medicinal options:**



**Misoprostol**



**Prostaglandin**



**General Anesthetic**



**Paracetamol**



**Methyldopa**



**Ceftriaxone**



**Ringer Solution**



**NaCl**



➤ BE READY TO DISCOVER THE WORLD'S ONLY BIOFIDELIC TECHNOLOGY THAT DELIVERS A TRUE HANDS-IN-THE-BODY SURGICAL EXPERIENCE



### C-Celia™ Emergency Obstetric Suite

Obstetric surgery skills and procedural training can be true-to-life with the C-Celia suite of five birthing simulators. The materials used in the simulator feel life-like (no hard plastics), are very durable and easy to clean.

***The unprecedented anatomical and surgical fidelity of the soft tissue used will provide the most comprehensive training experience for mastering:***

- + Cesarean Deliveries
- + Difficult Fetal Extraction
- + Postpartum Hemorrhage Control
- + Emergency Hysterectomy

 WATCH THE VIDEO ONLINE TO SEE HOW THE 4 C-CELIA SIMULATORS CAN ENHANCE OBSTETRIC SIMULATION AND SKILL TRAINING



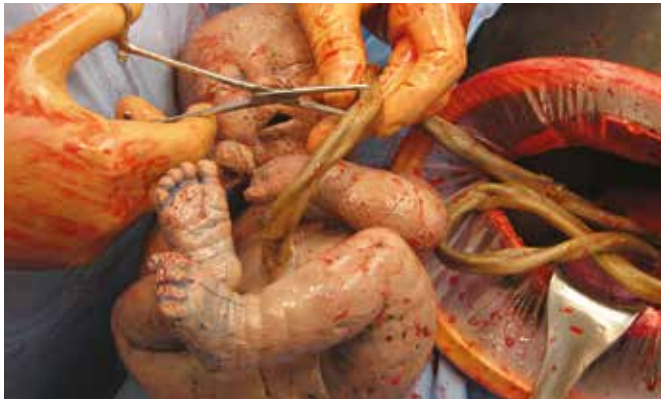

**Full-term baby manikin of unprecedented realism with umbilical cord and placenta**



**Fully operable uterus with life-like soft tissue**



**Repair of complex lacerations and uterine artery injuries**



**Accurate, highly realistic soft tissue**

Complete Cesarean Delivery Trainer	Fetal Extractions Deliveries Trainer	Postpartum Hemorrhage (PPH) Control Trainer	Cesarean Emergency Hysterectomy Trainer
<b>M-1022567</b>	<b>M-1022559</b>	<b>M-1022561</b>	<b>M-1022564</b>
<b>C-section delivery stage</b>			
Pregnant abdomen, pre C-section	Open abdomen with transverse Cesarean incision	Open, post C-section delivery abdomen	Open, post C-section delivery abdomen
<b>Cesarean delivery skills trained</b>			
<p><b>Emergency Cesarean delivery with:</b></p> <ul style="list-style-type: none"> <li>• Full transverse (Pfannenstiel incision) C-section</li> </ul> <p><b>Vertical emergency C-section (running from the umbilicus to the symphysis pubis) C-section through abdominal wall and uterus with incisions through:</b></p> <ul style="list-style-type: none"> <li>• Abdominal wall</li> <li>• Muscle</li> <li>• Fascia</li> <li>• Linea alba</li> <li>• Uterus</li> <li>• Amniotic sack</li> </ul>	<p><b>Difficult Cesarean deliveries as:</b></p> <ul style="list-style-type: none"> <li>• Cord prolapse</li> <li>• Single footling breech</li> <li>• Prolapsed arm</li> <li>• Triple nuchal cord</li> <li>• Transverse lie</li> </ul> <p><b>Train manual delivery:</b></p> <ul style="list-style-type: none"> <li>• Utilizing fundal pressure</li> <li>• Vacuum assisted extraction</li> <li>• Forceps extraction</li> </ul>	<p><b>Management of Postpartum Hemorrhage (PPH) after Cesarean delivery:</b></p> <ul style="list-style-type: none"> <li>• Repair of complex lacerations and uterine artery injuries</li> <li>• Supports PPH control techniques like Bakri Balloon, B-Lynch or Hayman sutures and O-Leary Stitch</li> <li>• Surgical PPH control: Compressive uterine sutures, uterine arteries ligation</li> <li>• Non-surgical PPH control: uterine fundal massage, bimanual uterine massage, uterine packing, tamponade</li> </ul>	<p><b>Postpartum and Cesarean hysterectomy:</b></p> <ul style="list-style-type: none"> <li>• Hemorrhage control</li> <li>• Clamping and cutting of uterine arteries</li> <li>• Fully operable removal of uterus</li> </ul>
<b>Features</b>			
<ul style="list-style-type: none"> <li>• Includes 1 set of twin babies (with umbilical cord and placenta)</li> <li>• Simulated amniotic fluid</li> </ul>	<ul style="list-style-type: none"> <li>• Includes 1 set of twin babies (with umbilical cord and placenta)</li> </ul>	<ul style="list-style-type: none"> <li>• Integrated pressurized bleeding system</li> </ul>	<ul style="list-style-type: none"> <li>• Contains uterus, bladder, ureters and detailed representation of uterine arteries</li> </ul>

## RealMom™ 2.0 Birthing Simulator for Realistic Obstetric Training

Practice vaginal deliveries with natural-feeling soft tissue, accurate internal anatomy and landmarks, and an authentic pelvic structure with an active soft tissue birth canal. The RealMom 2.0 full-body birthing simulator is wireless and can be remotely controlled with an easy to use instructor tablet (included).

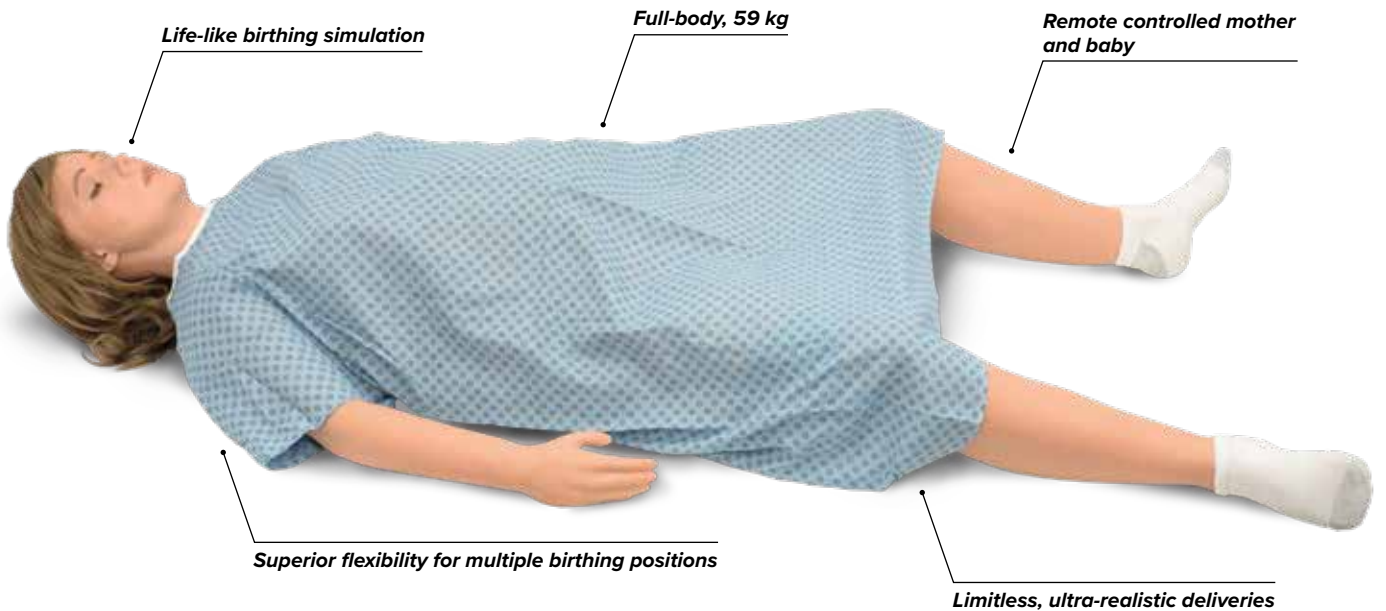

## ▶ THE WORLD'S MOST NATURAL AND REALISTIC VAGINAL BIRTHING SIMULATOR

### Unprecedented Realistic Material

RealMom 2.0 full-term baby and mother are made of an extremely realistic material that feels almost natural, no hard plastics are used as they reduce the realism of obstetric training. This birthing simulator provides human-like dilation and effacement with massageable fundus and amniotic reservoir. It also includes a very realistic baby with placenta and umbilical cord.

With the RealMom 2.0 birthing simulator, you can train the following skills:

#### Natural Delivery:

- Normal delivery without complications
- Breech delivery
- Shoulder dystocia (MacRoberts Maneuver)
- Compound delivery
- Nuchal cord
- Cord prolapse
- Placenta previa

#### Assisted Delivery:

- Assisted delivery with forceps
- Assisted delivery with vacuum
- Perform upright, side-lying and other alternative birthing positions

#### Postpartum Hemorrhage (PPH):

- Train the management of PPH with appropriate flow control and the ability to stop hemorrhage with a Bakri or Ebb Balloon

#### The Instructor Control Software requires very little programming or set-up.

The Software provides instructors with an intuitive and easy-to-use interface for remote control of vital signs via Tablet: Mother heart rate (0-220 BPM) with presets for:

- Normal
- Tachycardia
- Bradycardia

- Fetal heart rate (0-220 BPM)

- Mother Bleedings presets:

- Off
- Normal
- Impressive
- Maximum

- Respiratory rate (0-60)

- Cervical effacement, dilation and station

- Blood pressure

- SpO<sub>2</sub>

- Temperature

**M-1022179**







**Life-like Mother and Baby**

Full-body birthing simulator and full-term baby with unsurpassed realism and life-like appearance. Features realistic, silicone-based soft tissue and accurate internal anatomy.



**Natural Delivery**

The natural active, soft tissue birth canal provides human-like dilation and effacement with massageable fundus and amniotic fluid reservoir. Offers limitless ultra-realistic deliveries.



**Practice Multiple Birthing Positions**

Advanced internal skeletal structure provides accurate movement and flexibility of body and limbs. Enables to perform upright, side-lying and other alternative birthing positions.



**Enhanced Range of Deliveries**

Provides normal delivery, breech, shoulder dystocia, nuchal cord, cord prolapse, transverse and placenta previa, compound delivery.



**Fully Operable**

Vacuum assisted and operative forceps deliveries can be fully trained and teach multiple times on a realistic soft birth canal. Postpartum hemorrhage can be effectively controlled with Bakri or Ebb balloon.



**Remotely Controlled**

Intuitive and easy-to-use interface to manage dilation and delivery progression, physiological presentation and control of maternal and fetal vital signs. iOS, Android and computer browsers compatible.



**WATCH THE VIDEO ONLINE TO SEE HOW REALMOM 2.0 CAN ENHANCE OBSTETRIC SIMULATION AND SKILL TRAINING**





## SMART MOM Birthing Simulators

**Obstetric simulators focused on the two primary challenges in OB deliveries:**

- Postpartum Hemorrhage (PPH)
- Shoulder Dystocia

SMART MOM Birthing Simulators also exhibit a wide range of other birthing irregularities. Extensive Fetal Heart Rate (FHR) programming ensures a broad exposure to variations in waveforms to test your knowledge and team leadership skills in handling patient treatment modalities. The iPad® controls the birthing position and rotation of the fetus, descent speed, vaginal bleeding, amniotic fluid, meconium, and the mother's physiological condition in an easy-to-use application. Scenarios are included with the packages and make physiological changes to treatments simple and quick.

### **Easy-to-use iPad® controls ALS features:**

- Bilateral IV and BP arms
- 5-lead ECG monitoring
- Intubation
- Papillary responses
- 10 active pulse points

### **Obstetrics features:**

- Choice of delivery system: BASIC version with manual delivery or advanced version with auto delivery
- Baby, placenta, and umbilical cord
- 6 vaginal fluids for discharge
- Palpation of fetus and delivery at same time
- 10 scenarios (made up of 36 vignettes)
- Flat-screen monitor
- Laptop monitor
- FHR chart Program

Both versions come complete with adjunct baby for Leopold's maneuvers and birthing baby with placenta, umbilical cord, and first breath action. Accessories included: BP cuff, flat-screen monitor for FHR, tablet and laptop for mother's monitor, pulse oximeter, replacement skin and veins, replacement vagina and cervix, wheeled carrying case.

### **SMART MOM BASIC Birthing Simulator**

The BASIC version comes with a manual delivery system and a Simulaids-engraved iPad®.

**M-1018474**

### **SMART MOM with Auto Delivery**

The advanced version comes with an automated delivery system and a Simulaids-engraved iPad®. In addition to all features of SMART MOM BASIC, comes with a crying fetus and edema ankles.

**M-1020765**



**Manual or automated delivery**



**Shoulder Dystocia and other obstructed labor**



**Pulse oximeter**



**Life-like birthing simulation**

## Lucy Maternal and Neonatal Birthing Simulators

The new family of Life/form® Lucy Maternal and Neonatal Birthing Simulators is a comprehensive birthing simulation solution covering obstetrical events from prenatal to postnatal delivery scenarios with a new level of physical realism for an emotionally engaging learning experience.

Lucy Birthing Simulators have been designed to provide a comprehensive and economical birthing experience from prenatal to postnatal delivery scenarios. It allows students to experience realistic normal and abnormal deliveries. The quality and simple design make Lucy easy to use and care for, while teaching patient techniques for all levels of educator training.

Lucy comes in three different versions to meet your individual clinical and economic training requirements:

**Basic (M-1021721), Complete (M-1021722), and Advanced (M-1021723).**

**All three Lucy Maternal and Neonatal Birthing Simulators have the following features:**

- Deliveries: Vaginal, breech, cesarean, forceps
- Assisted, shoulder dystocia and vacuum
- Assisted birthing positions on hands and knees, lateral and supine
- 6 stages of cervical dilation
- Abdominal fetal palpation (Leopold's maneuvers)
- Episiotomy
- Postpartum hemorrhage
- Airway management: Intubation and ventilation with chest rise
- Oral and nasal care
- Lavage, gavage, suctioning
- CPR
- Intramuscular injection sites
- Scale electrode placement



➤ PLEASE REFER TO THE TABLE BELOW TO FIND A LUCY BIRTHING SIMULATOR THAT BEST FITS YOUR REQUIREMENTS

	Basic Lucy	Complete Lucy	Advanced Lucy
Item No.	M-1021721	M-1021722	M-1021723
Airway Management	✓	✓	✓
CPR	✓	✓	✓
Postpartum hemorrhage	✓	✓	✓
Clotting blood	-	✓	✓
Blood pressure arm	-	-	✓
Complete set of clots and hemorrhages	-	✓	✓
IV Arm	-	-	✓
Micro-Preemie Simulator	-	-	✓
Newborn Nursing Skills and ALS Simulator	-	✓	✓
Small soft carrying case	-	-	included
Large soft rolling carrying case	-	included	included



- + Anatomically accurate
- + Easy to use and care
- + Economical birthing experience from prenatal to postnatal delivery scenarios



Normal and difficult deliveries



IM Injections



Intubation



Blood pressure

## NOELLE® Birthing Simulators

This comprehensive teaching system combines a patient care simulator and an advanced childbirth simulator.

**The complete birthing experience before, during and after delivery includes:**

- Practice of Leopold's maneuvers
- Automatic birthing system
- Measure head descent and cervical dilation
- Practice of postpartum suturing on vulval inserts
- Replaceable dilating cervixes
- New postpartum hemorrhage and palpation module
- Multiple fetal heart sounds heard through conventional stethoscope
- Practice of shoulder dystocia interventions
- Monitor and log ventilations and chest compressions with the included Omni® Code Blue Pack

**Model shown: Noelle® Birthing Simulator with Pedi® Blue Neonate Neonate M-1012732**

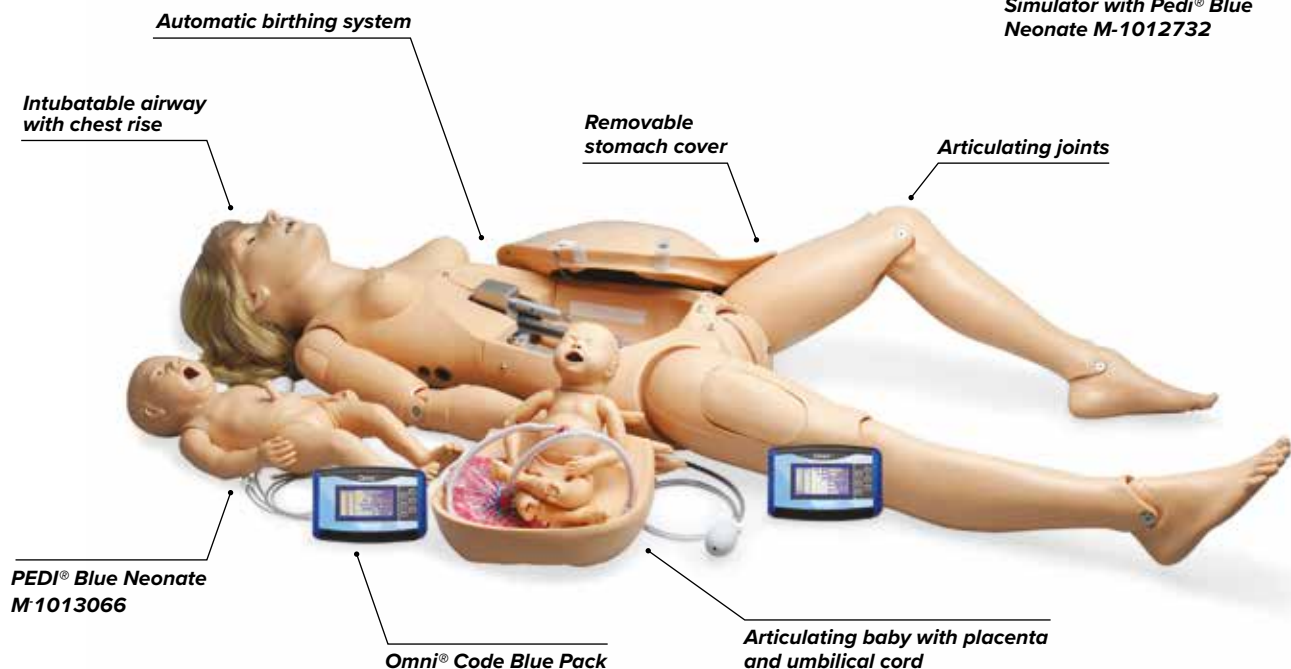

## NOELLE® is available in these additional configurations:

### NOELLE® Birthing Simulator with Birthing Baby

Full-body manikin delivered with one articulating birthing baby with placenta and one maternal OMNI® Code Blue Pack controller. NOELLE® Training Guide & Teaching Tips, carrying bag, talcum powder, lubricant, and instruction manual included.

**M-1005815**

### NOELLE® Birthing Simulator with Birthing and Resuscitation Baby

Full-body manikin delivered with one resuscitation baby with intubatable airway and umbilical catheter site, one articulating birthing baby with placenta and one maternal OMNI® Code Blue Pack controller. NOELLE® Training Guide & Teaching Tips, carrying bag, talcum powder, lubricant, and instruction manual included.

**Light Skin M-1012417**  
**Dark Skin M-1017860**

### NOELLE® Birthing Torso with Birthing Baby

Torso delivered with one articulating birthing baby with placenta and one maternal OMNI® Code Blue Pack controller. NOELLE® Training Guide, carrying bag, talcum powder, lubricant, and instruction manual included.

**M-1015567**

### Noelle® Birthing Simulator with Pedi® Blue Neonate

Full-body manikin delivered with one PEDI® Blue Neonatal Simulator with SmartSkin™, one articulating birthing baby with placenta and two OMNI® Code Blue Pack controllers (one maternal and one neonatal). NOELLE® Training Guide & Teaching Tips, carrying bag, talcum powder, lubricant, and instruction manual included.

**Light Skin M-1012732**  
**Dark Skin M-1017865**



**Extensible dilating cervix permits students to conduct vaginal exams and record results**



**Monitor ventilations and chest compressions with Omni Code Blue® pack**

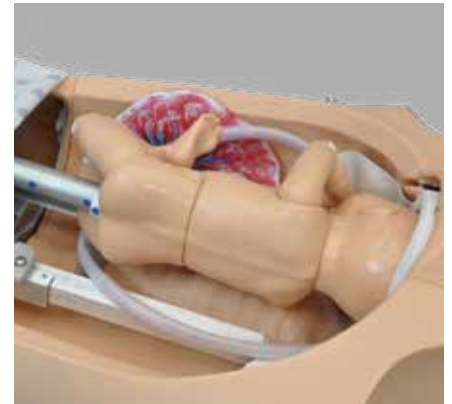

**Automatic birthing system**

**➤ PLEASE TAKE A LOOK AT THE TABLE BELOW TO FIND A NOELLE® BIRTHING SIMULATOR THAT BEST FITS YOUR REQUIREMENTS**

	<b>Birthing Simulator with Pedi® Blue Neonate</b>	<b>Birthing Simulator with Birthing and Resuscitation Baby</b>	<b>Birthing Simulator with Birthing Baby</b>	<b>Birthing Torso with Birthing Baby</b>
<b>Item No.</b>	<b>Light Skin M-1012732 Dark Skin M-1017865</b>	<b>Light Skin M-1012417 Dark Skin M-1017860</b>	<b>Light Skin M-1005815</b>	<b>Light Skin M-1015567</b>
<b>Full-body/Torso</b>	full-body	full-body	full-body	torso
<b>Baby</b>				
<b>PEDI® Blue Neonate (M-1013066)</b>	included	–	–	–
<b>Articulating baby with placenta</b>	included	included with additional resuscitation baby	included	included
<b>Multiple fetal heart sounds</b>	✓	✓	✓	–
<b>Mother</b>				
<b>Intubatable airway with chest rise</b>	✓	✓	✓	–
<b>Bilateral carotid, radial and brachial pulses</b>	✓	✓	✓	–
<b>IM sites</b>	✓	✓	✓	–
<b>IV arm</b>	✓	✓	✓	–
<b>Birth</b>				
<b>Birthing system</b>	automatic	automatic	automatic	automatic
<b>Practice of Leopold's maneuver</b>	✓	✓	✓	✓
<b>Measure head descent and cervical dilation</b>	✓	✓	✓	✓
<b>Two umbilical cords, dilating cervixes and umbilical clamps</b>	✓	✓	✓	✓
<b>Replaceable dilating cervixes</b>	✓	✓	✓	✓
<b>Postpartum</b>				
<b>Episiotomy</b>	✓	✓	✓	✓
<b>Postpartum hemorrhage (PPH)</b>	✓	✓	✓	–
<b>Perineum Insert</b>	✓	✓	✓	–

## 3B Scientific® Birthing Simulator P90 PRO

The birthing simulator offers extremely realistic training features. It was developed specifically for the skill training in normal and complicated deliveries as well as for obstetric emergency training.



### **Assessment and manipulation of fetal positions:**

Using the simulator, trainees will learn how to detect abnormal positions and presentations, and how to use manual techniques to assist the birthing process. Training of manual birthing maneuvers (like Leopold or Pinard's) can be trained so that correct measures will be applied during complicated deliveries. Furthermore, the trainee will learn when to apply obstetric emergency interventions (like a cesarean section).

### **Train the following delivery skills and techniques:**

- Normal vaginal delivery
- Normal delivery of umbilical cord and placenta
- Palpation and assessment of fetal position and presentation
- Demonstration of all normal and abnormal fetal positions and presentations (like face, neck, or brow) to represent routine and difficult deliveries
- Intrauterine manipulation of fetus
- Shoulder dystocia (adaptive birth canal and pelvic bones) demonstration and management
- Breech deliveries (including complete, footling or incomplete, and frank breech presentation)
- Palpation of fetal fontanelles features
- Complete and incomplete placenta birth
- Demonstration of placenta previa: total, partial, and marginal
- Prolapse of umbilical cord
- Nuchal umbilical cord
- Cesarean delivery
- Artificial rupture of membranes
- Clamping and cutting of umbilical cord
- Demonstrate suctioning of baby's mouth and nose
- Manual maneuvers (such as Leopold, Pinard's, Mauriceau, Prague, Woods and Rubin maneuver)

### **Delivery content:**

- 3B Scientific® Birthing Simulator P90 PRO
- Detachable, padded stomach cover with advanced insert for caesarian section
- Inflatable uterus insert for Leopold maneuver including cover that can be cut for caesarian section
- Realistic birth canal (portio, cervix, vulva)
- Fastening belt
- Lubricant
- Amniotic fluid and 100 inserts
- Assembly Kit
- Fully articulating fetal baby
- Umbilical cord and placenta

**M-1020333**

### **3B Scientific® Birthing Simulator P90 BASIC**

The BASIC version of the 3B Scientific® Birthing Simulator offers all features of the PRO version but comes with a pre-cut cesarean insert and a BASIC birth canal. It does not include an amniotomy insert nor an inflatable uterus for Leopold.

### **Delivery content:**

- 3B Scientific® Birthing Simulator P90 BASIC
- Detachable, padded abdomen cover with BASIC insert with pre-cut cesarean section
- BASIC birth canal
- Lubricant
- Assembly Kit
- Fully articulating fetal baby
- Umbilical cord and placenta

The 3B Scientific® Birthing Simulator P90 BASIC can be upgraded to the PRO version with the Upgrade Kit M-1020337.

**M-1020332**



## Upgrade Kit for 3B Scientific® Birthing Simulator P90 BASIC

With this Upgrade kit, the BASIC version of the Birthing Simulator will include all features of the PRO version.

### Delivery content:

- Abdominal wall with Cesarean insert made of cuttable silicone
- Inflatable uterus insert (Leopold maneuver) with cuttable and exchangeable upper uterine wall
- Anatomically shaped cervix and modeled vulva with vagina (birth canal)
- Safety strap for securing the simulator to a table or bed
- Amniotic inserts and fluid for artificial rupture of membranes
- Lubricant Gel (2x 250 ml)

**M-1020337**

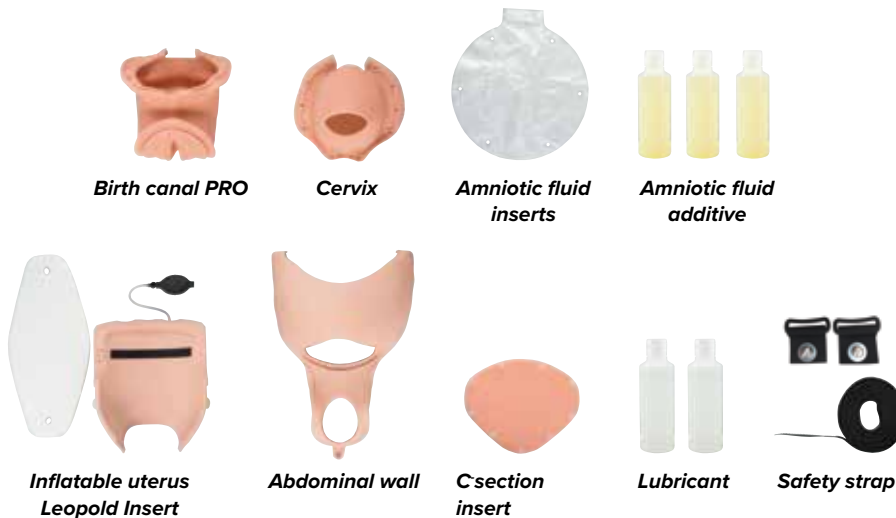
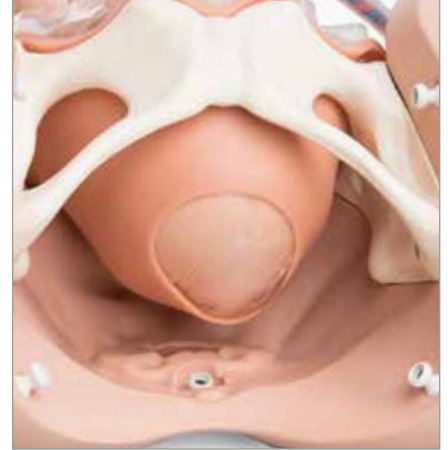

Description	Item No.	P90 BASIC	P90 PRO
<b>Replacement parts</b>			
Complete baby set	M-1020336	✓	✓
Birth canal and cervix (2x birth canal / 1x cervix)	M-1020342	-	✓
Birth canal and cervix (1x birth canal / 1x cervix)	M-1020343	-	✓
Abdominal wall BASIC	M-1020344	✓	-
Birth canal BASIC	M-1020345	✓	-
C-section insert BASIC	M-1020346	✓	-
<b>Consumables</b>			
Uterine wall for Leopold insert	M-1020338	-	✓
C-section insert PRO	M-1020339	-	✓
Complete abdominal wall set PRO	M-1020340	-	✓
Amniotic fluid insert	M-1020341	-	✓
Umbilical cord set	M-1020347	✓	✓
Lubricating gel (2 x 250 ml)	M-1020608	✓	✓
<b>Options</b>			
Inflatable uterus Leopold insert	M-1020367	✓	✓
Upgrade Kit BASIC to PRO	M-1020337	✓	-

### Episiotomy Suture Training Module P96

Add easily to the Birthing Simulator P90 PRO/BASIC our new Episiotomy insert P96 features to enhance the competence and the confidence of the healthcare professional providing postpartum care. See more information on page 11!

**M-1022212**



### 3B Scientific® PPH Trainer P97

Postpartum Hemorrhage (PPH) is commonly defined by the World Health Organization as “a blood loss of 500 ml or more within 24 hours after birth, while severe PPH is defined as a blood loss of 1,000 ml or more within the same timeframe. PPH affects approximately 2% of all women who give birth: it is associated not only with nearly one quarter of all maternal deaths globally but is also the leading cause of maternal mortality in most low-income countries”<sup>1</sup>.

The PPH trainer from 3B Scientific® is designed to be an affordable, versatile and realistic training tool, which will enhance the competence and the confidence of the healthcare professional providing postpartum care and managing postpartum bleeding.

<sup>1</sup> WHO recommendations on prevention and treatment of postpartum hemorrhage (2012)

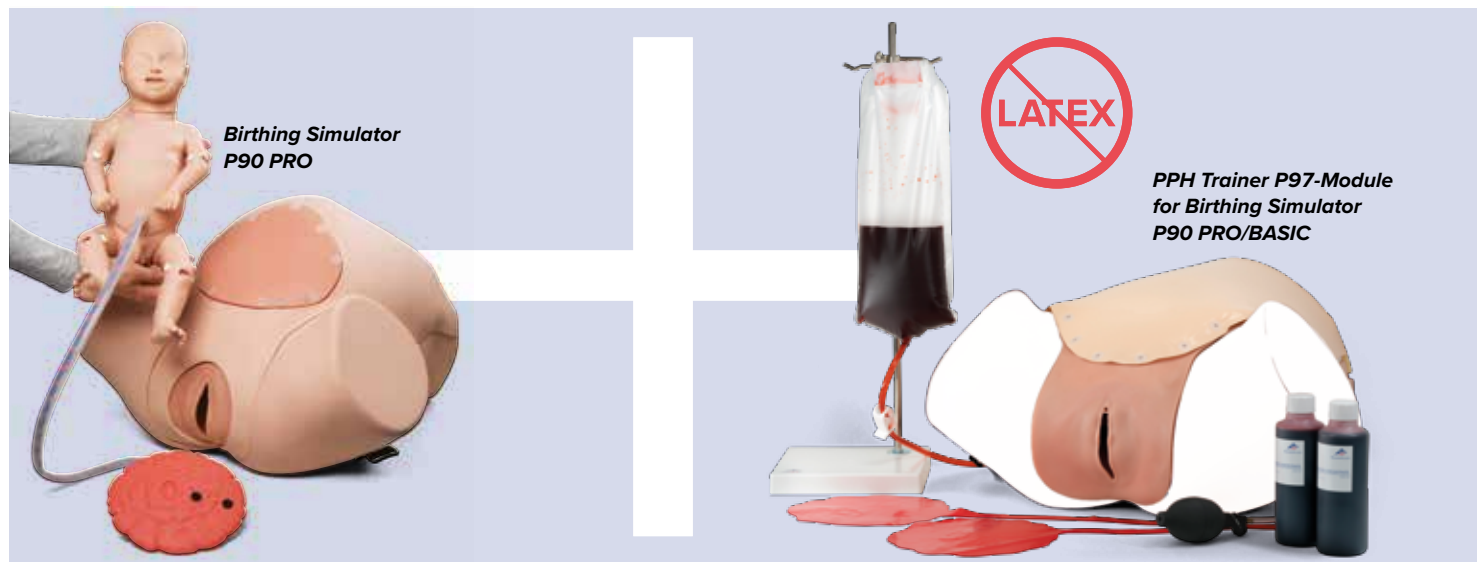





**Placenta Incomplete Simulation**  
Detachable placenta pieces



**Blood Loss Identification**  
3 possible bleeding settings: uteral, cervical and vaginal



**Important Bleeding Capacity**  
Capacity of 1.5 l blood loss to practice the blood loss visual estimation

**The trainer will be useful for training the following procedures:**

- Delivery of placenta, also incomplete
- Identification of the blood loss nature: uterus, cervix, vagina
- Visual estimation of the blood loss volume
- Atonic uterus management
- Practice the fundal massage
- Perform bimanual compression
- Practice catheterization

**Features:**

- Adult size lower torso with accurate anatomy, including ischial spines, pubic bones and sacrum for a realistic examination
- Offers a realistic simulation of an atonic or contracting postpartum uterus
- Adjust easily uterine tone with the pump attachment
- Realistic post-delivery cervices

**Offers 3 different PPH bleeding natures:**

- Uterus bleeding
- Cervix bleeding (rupture)
- Vaginal bleeding (lesion)
- Allows simulation of a bleeding up to 1,500 ml
- Simulation of a complete and incomplete placenta delivery
- Urethra built for catheterization with CH 14 catheter

**Delivery content:**

- PPH Trainer P97
  - Blood Reservoir
  - Artificial Blood Concentrate (2 x 250 ml)
  - 2 Placentas
- M-1021568**



At 3B Scientific we strive for providing you with solutions that can also be tailored to your needs. The PPH Trainer P97 is therefore also available as an add-on module for our Birthing Simulator P90 PRO and P90 Basic.

**There are two options available:**

**1) PPH Trainer P97-Module for Birthing Simulator P90 PRO/BASIC**

The PPH module P97 is easy to integrate into the Birthing Simulator P90 PRO and BASIC and will complete your obstetric suite.

**Delivery content:**

- Delivery content:
- PPH Trainer P97-Module
- Blood Reservoir
- Artificial Blood Concentrate (2 x 250 ml)
- 2 Placentas

**M-1021567**

**2) PPH Trainer P97-Module with Birthing Simulator P90 PRO**

**Delivery content:**

- PPH Trainer P97-Module
- Blood Reservoir
- Artificial Blood Concentrate (2 x 250 ml)
- 2 Placentas
- Birthing Simulator P90 PRO
- Detachable, padded stomach cover with advanced insert for caesarian section
- Inflatable uterus insert for Leopold Maneuver including cover that can be cut for caesarian section

- Realistic birth canal (portio, cervix, vulva)
- Fastening belt
- Lubricant (2 x 250 ml)
- Amniotic fluid and 100 inserts
- Assembly Kit
- Fully articulating fetal baby
- Umbilical cord and placenta

**M-1021570**



**Susie® OB Simulator**

This versatile skills trainer offers practicing routine delivery techniques and often-seen complications. Delivered with padded abdominal cover, 3 dilating cervixes, 3 vulva inserts, articulating birthing baby, 2 placentas, 3 umbilical cords, 2 umbilical clamps, episiotomy perineum insert, 48 hour postpartum uterus, elevating pillow, silicone lubricant, talcum powder and carrying bag.

**M-1013558**

**Susie® Advanced OB Simulator**

This battery powered birthing simulator offers more than 30 hours of operation and uses durable materials for years of usage. Delivered with midwifery gown, two pair of non-latex gloves, suction bulb, conventional stethoscope, Pinard stethoscope, blood collection stand with squeeze bulb, simulated blood and urine concentrate, 1 non-sterile urinary catheter, 3 distensible cervixes, 2 placentas with removable fragments, silicone lubricant and talcum powder, instruction manual and carrying bag.

**M-1019303**



*Vacuum assisted delivery*



*Realistic fetus with fontanels*



*Normal and complicated delivery*



**Birthing Simulator**

Features the pelvic cavity with major anatomical landmarks and painted outline of bony pelvis. The birthing simulator allows intra-uterine manipulation and various training possibilities for prenatal, intrapartum, and postpartum skills. Supplied with 2 stomach covers (skin-tone/transparent), 1 male and 1 female fetus with placenta, 5 umbilical cords, 2 umbilical clamps, talcum powder and carrying bag.

**M-1005790**

Other available add-ons for Birthing Simulator M-1005790	Item No.
Birthing System	M-1013794
Birthing Stations Insert	M-1005824
Palpation Module for Leopold's maneuvers	M-1005823
Articulating Fetus	M-1005814
Fetus for vacuum delivery	M-1005791



**Articulating Fetus M-1005814**

### Obstetrical Manikin

This life-like birthing simulator gives your trainees practice in normal vaginal delivery as well as birthing procedures for breech and vertex presentation of the fetus. It includes two interchangeable abdominal overlays – one containing an additional fetus in a simulated amniotic fluid sac for practicing Leopold’s maneuver, the other being transparent to allow viewing of the fetal position during labor. Anatomically correct female pelvis with representation of internal landmarks such as spinal column, angled birth canal, ileum, ischium, sacrum, sacro spinous ligaments and greater sciatic notch. Includes full term fetus with fontanelles and cranial sutures and placenta with six disposable umbilical cords and clamps.

**M-1000002**



➤ PLEASE TAKE A LOOK AT THE TABLE BELOW TO FIND AN OBSTETRICAL TRAINER THAT BEST FITS YOUR REQUIREMENTS

	Birthing Simulator	Original Child-birth Simulator®	3B Birthing Simulator PRO	OB Susie®	Advanced OB Susie®
Item No.	M-1000002	M-1005790	M-1020333	M-1013558	M-1019303
<b>Baby</b>					
Fetus	fetus with fontanelles and cranial sutures	male and female articulating fetus	male articulating fetus with fontanelles	articulating fetus	articulating fetus
Palpation of fetal fontanelles	✓	✓	✓	✓	✓
Audible maternal and newborn heart sounds	-	-	-	-	✓
<b>Birth</b>					
Birthing mechanism	manual	manual	manual	manual	automatic
Complete, frank, and footling breech birth	✓	✓	✓	✓	✓
Cesarean section delivery	-	✓	✓	✓	✓
Complete and incomplete placenta birth	only complete	only complete	✓	only complete	only complete
Artificial Rupture of Membranes (AROM)	-	-	✓	-	-
Intrauterine manipulation	-	✓	✓	✓	✓
Cord prolapse and placenta previa	✓	✓	✓	✓	✓
<b>Maneuvers</b>					
Ritgen's	-	✓	✓	✓	-
Leopold's	✓	✓	✓	✓	✓
Pinard's and Prague's (Breech)	-	✓	✓	✓	✓
Mauriceu-Smellie-Veit (Breech)	-	-	✓	✓	✓
Rubin's and Wood's (Shoulder Dystocia)	-	-	✓	✓	✓
<b>Postpartum</b>					
Episiotomy	-	✓	-	✓	-
Fundal massage	-	✓	-	✓	✓
Boggy uterus	-	via optional module	-	✓	✓
Postpartum Hemorrhage (PPH)	-	via optional module	via optional module M-1021567	-	✓
Clamping and cutting of umbilical cord	-	-	✓	✓	✓



## ➤ PRACTICE REALISTIC PRENATAL CERVICAL EXAMINATIONS

### 3B Scientific® Birthing Stages Trainer P94

Determine the labor progress using 6 pelvic inserts with various levels of cervical dilation and effacement.

The trainer consists of a set of 6 different pelvic inserts with very realistic anatomical details. The inserts can be used both as stand-alone trainers and as an extension module for the Birthing Simulator P90 (see page 86).

The inserts look the same from the outside and the birthing stations can only be identified by examination or by reading the number written on the back of the trainers.

### The following levels and birthing stages are represented:

1. Cervix closed (0.5 cm), level -2
2. Cervix open 2 cm, level -2
3. Cervix open 3 cm, half effaced, level -2
4. Cervix open 5 cm, effaced, level -1
5. Cervix open 7 cm, effaced, level -1
6. Cervix open 10 cm, effaced, level 0

### Delivery content:

- 6 birth stage inserts
  - Safety plate with 4 screws (for the optional insert in birth simulator P90, see page 86)
  - Lubricant gel
  - Carrying bag
- Made of latex-free, silicone-based material.  
**M-1020628**

### Lubricant (2 x 250 ml)

Can also be ordered separately.  
**M-1020608**



1: Cervix closed (0.5 cm), level -2



2: Cervix open 2 cm, level -2



3: Cervix open 3 cm, half effaced, level -2



4: Cervix open 5 cm, effaced, level -1



5: Cervix open 7 cm, effaced, level -1



6: Cervix open 10 cm, effaced, level 0



USE THE INSERTS ALONE OR AS AN ADDITION TO BIRTHING SIMULATOR P90 – SEE PAGE 86 FOR MORE INFORMATION!



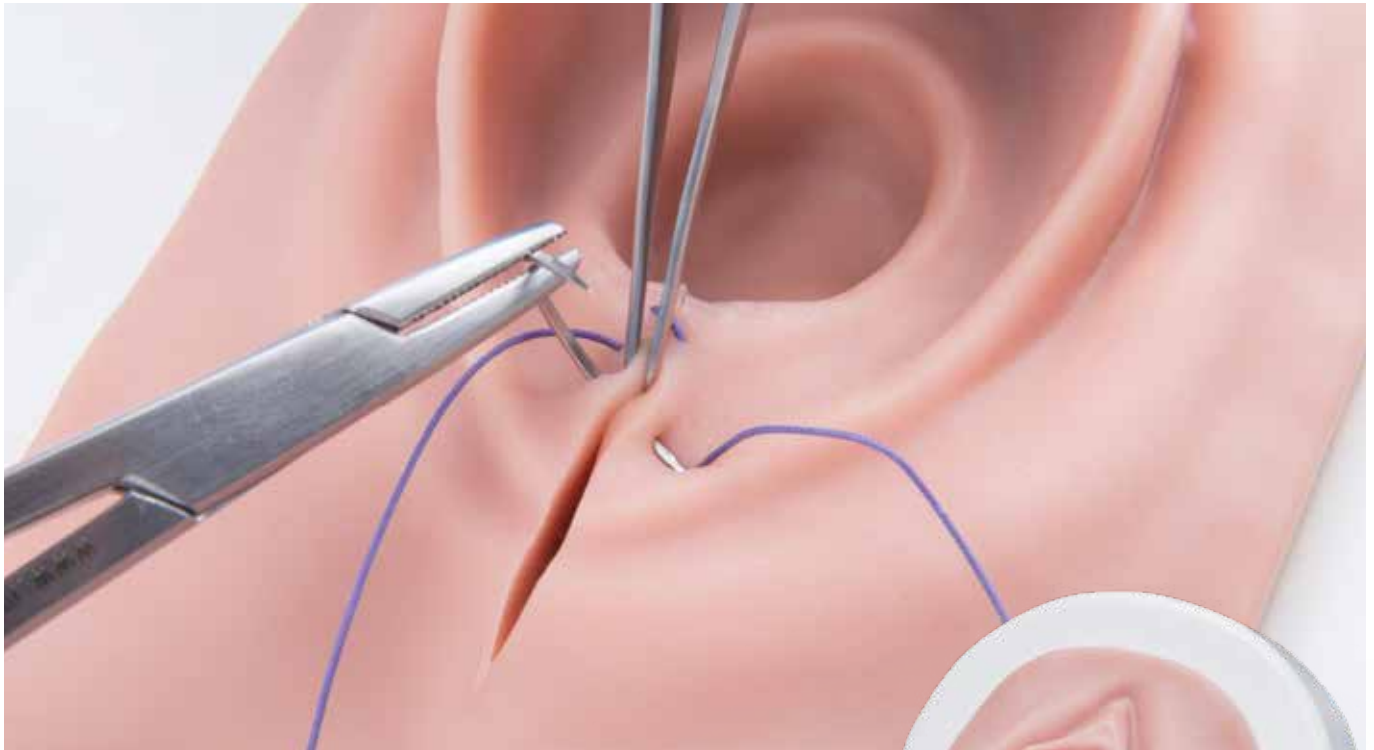

### 3B Scientific® Episiotomy and Suturing Simulator P95

Life-like texture and separate skin and muscle layers for very realistic training of suturing techniques for episiotomies as well as vaginal and labial tears. Each cut can be sutured several times. The trainee will gain experience in instrument handling as well as suture techniques and tying knots.

**With this trainer, taking care of the following birth injuries can be practiced and demonstrated:**

- Median episiotomy
- Mediolateral episiotomy
- Lateral episiotomy
- Vaginal tears
- Labial tears

**To make caring for and closing these birth wounds as realistic as possible, the following muscle structures can be palpated and sutured in the perineal area:**

- M. sphincter ani externus (outer anal sphincter muscle)
- M. transversus perinei superficialis (superficial transverse perineal muscle)
- M. bulbospongiosus (bulbospongiosus muscle)
- Muscle and skin layers can be sutured separately

The adjustable base holder stands firmly on the table without slipping and enable a more realistic training angle during suture. The insert can be taken out of his base and then worked on while it is lying on the table. This value-for-money tissue insert can be bought individually or in packs of 5 inserts.

#### **Delivery content:**

- Episiotomy Silicone insert
- Base
- Stand

Made of latex-free, silicone-based material.

**M-1019639**



Consumables and replacement parts	Item No.
Replacement insert for episiotomy trainer	M-1019640
Replacement insert set for episiotomy trainer (Set of 5)	M-1019641
Suturing kit (episiotomy and suture trainer)	M-1020767

# GYNECOLOGY

➤ PERFECT HANDS-ON ADDITION TO ANY GYNECOLOGY SKILLS CURRICULA



## 3B Scientific® Gynecologic Skills Trainer P91

The Gynecologic Skills Trainer P91 is a full-sized, adult lower torso made of 3B Scientific SKINlike™ high-quality silicone for a realistic look, feel and texture in addition to a life-like softness offered during palpation. It is a new versatile training tool designed to add hands-on experience for learners practicing gynecologic skills.

The P91 Gynecological Skills Trainer is an excellent tool for developing confidence and skills to provide patients with high-quality, comprehensive care.

*The trainer will be useful for demonstrating the following procedures:*



### **Bimanual Examination**

Realistic, flexible vaginal canal provides ideal examination practice



### **Speculum Examination**

SKINlike™ high-quality silicone offers realistic resistance and elasticity



### **Tenaculum Practice**

Use of real gynecologic tools

**The trainer will be useful for demonstrating the following procedures:**

- Perform bimanual examinations with palpable, realistic, normal and abnormal uteri
- Perform vaginal examination with speculum
- Practice use of tenaculum
- Train vaginal examination with easily interchangeable cervixes and have visual recognition of normal and abnormal anatomy variations
- Evaluate multiple conditions using the interchangeable cervixes “normal” and “pathologic”
- Pap test for cervical screening
- Practice catheterization
- Suppository administration in the patent rectum

**Features:**

- Adult-sized female lower torso with accurate anatomy, including ischial spines, pubic bones and sacrum for a realistic examination
- Leg stumps already in examination position and with the gynecologic examination wedge the possibility to simulate a leaned position of the patient as in a gynecological examination chair
- Soft abdominal cover allows bimanual palpation of normal and abnormal uterus
- Offers realistic flexibility of the vaginal wall
- Seamless, flexible skin for practice of speculum placement
- The bladder can be simulated full or empty to make the palpation of the structure possibly restricted
- Urethra built for catheterization simulation with CH 14 catheter
- Use easy interchangeable cervixes for visualization with speculum
- Normal Fallopian tubes are removable and replaceable by abnormal fallopian tubes with an ectopic pregnancy

**M-1021592**

Consumables and replacement parts	Item No.
Abdominal Cover	M-1021596
Uteri (Set of 4)	M-1021595
Cervices (Set of 6)	M-1021593
Vagina Insert	M-1021600
Ectopic Pregnancies Set	M-1021656

**Multiple interchangeable uteri to teach specific skills to all training levels:**

- Normal uterus
  - Bicornate uterus
  - Stretched uterus with removable myomas
  - Big size uterus (13 cm large, 11 cm high)
- The normal uterus can be used to simulate an anteverted uterus or a retroverted uterus. Ectopic pregnancy can be simulated on all the uteri.



**Set of 5 cervices for visual recognition of normal and abnormal characteristics including:**

- Nulliparous or para 0
- Multiparous
- Cervical erosion (ectropion)
- Cervical dysplasia
- Carcinoma
- Barrel-shaped carcinoma



**Visual Cervices Examination**

Normal and pathologic cervixes easily interchangeable



**Catheterization**

Practice didactic catheterization



**Suppository Administration**

Present a patent rectum

## ► DEMONSTRATE AND PRACTICE MULTIPLE PROCEDURES!

### ZOE Gynecological Simulator

This simulator represents a female adult lower body with relevant internal anatomical landmarks and anatomically accurate fimbriae and ovaries. It combines and delivers the ability to demonstrate multiple gynecological procedures, practice laparoscopic examination and mini-laparotomy, recognition of pathologies and placement of contraceptive devices.

#### Training features:

- Vaginal speculum and bimanual pelvic examination
- Uterine sounding
- Insertion and removal of contraceptive devices such as IUD, 75 mm diaphragm or female condom
- Laparoscopic visualization and occlusion of fallopian tubes
- Minilaparotomy

Includes talcum powder, lubricant and soft nylon carrying bag.

51 x 46 x 25,5 cm; 8.5 kg

**M-1005797**



Replacement parts and consumables	Item No.
7 Uteri – Normal with External Pathologies	M-1005798
7 Uteri – Normal with Internal Pathologies	M-1005799
Postpartum Uterus, 48 hours	M-1005812
Postpartum Uterus, 10 minutes	M-1017715
2 Early Pregnant Uteri	M-1005813
Normal Cervices	M-1019247



### EVA Gynecological Training Manikin

A life-like female pelvis for developing diagnostic skills in gynecological Procedures, anatomical instruction, abdominal palpation, and speculum instruction. The trainer allows the comprehensive, stress-free introduction of gynecological examinations or more advanced tactile comparisons of pelvic pathologic conditions in a classroom setting, easing the way into clinical experience.

Constructed of soft, easily cleaned, vinyl materials that approximate skin texture. Provides detailed, life-like anatomical features and references.

- Normal cervix and uterus for IUD insertion and removal
- Normal parous cervix
- Cervix with endocervical polyp
- Cervix with ectropion characteristics
- Cervix with neoplasia (carcinoma)
- Pregnant 10 week uterus
- 2 adnexal masses

Manikin comes with instruction sheet and soft nylon bag.

30.5 x 33 x 33 cm; 4 kg

**M-1005723**





### Cervical Exam and Pap Smear Test Simulator

The Pap test is the most frequently performed cancer screening test in the world. It is essential for women's healthcare practitioners to achieve competence in this vital but highly sensitive procedure. With the Life/form® Cervical Exam and Pap Test Trainer, students can practice external and internal examinations, speculum insertion, and cytological sampling techniques on a simulator that is incredibly realistic and easy to use. Features seven cervical conditions: normal, early pregnancy, polyp, early cancer, late cancer, inflammation and dysplasia.

#### About the simulator:

- Compact size for easy setup, storage, and transport
- Disassembles completely for easy cleaning
- Extra-soft material and lifelike detail give extremely realistic training experience
- Fraction of the cost of a full-size simulator
- Includes materials for making realistic body fluids and secretions
- Modular design offers quick change-out for different scenarios
- Movable cervix

Includes external genital pad, vagina, seven-piece cervix set in plastic case, support blocks, baby powder, methyl cellulose, blood packet, syringe, lubricant, and instruction manual.

Speculum and cytological sampling equipment not included.

**M-1018643**



### GYN/AID® Gynecological Simulator

This simulator represents a female adults lower body with soft outer skin as well as anatomically accurate fimbriae and ovaries. Various pelvic examinations including recognition of pathologies and placing of contraceptive devices can be trained.

#### Features:

- Vaginal speculum and bimanual pelvic examination
  - Uterine sounding
  - Insertion and removal of contraceptive devices such as IUD, diaphragm, cervical cap, contraceptive sponge or female condom
- The simulator is supplied with normal and abnormal cervixes and uteri which can be easily changed.

**M-1005789**



### Advanced Pelvic Examination and Gynecological Simulator

Now in one completely redesigned unit, the Advanced Pelvic Examination and Gynecological Simulator is ideal for all aspects of gynecological education, training, and competency evaluation, including the bimanual exam, speculum exam, and cytology sampling. Students will appreciate the unprecedented realism of its internal and external features; while instructors will love the interchangeable components that make up its unique modular system. Components can be combined in a multitude of ways. This simulator allows you the flexibility of customizing your scenarios with use of included makeup, blood, and thickener. Additional specialized modules are also available (STD, post-menopause, S.A.N.E. and pre-puberty).

#### Starter unit includes:

- Torso
- Normal genital pad
- Normal pelvic organ block with vagina and rectum
- Abdominal gel pad
- Fabric abdominal pad
- Abdominal overlay skin
- Seven uterus/cervix pieces (normal/normal with discharge option, retroverted/ cervicitis, cancer/cancer, transparent IUD, trainer, post-menopause/ herpes, fibroids/polyp, early pregnancy)
- Five detachable ovaries (normal polycystic, small cyst, large adnexal mass)
- Bladder insert
- Pelvic organ prolapse insert
- Baby powder
- Injury shades makeup wheel
- Primary colors makeup Wheel
- Blood mix
- Methyl cellulose thickener
- Syringe
- Lubricant
- Instruction manual
- Hard carrying case

**M-1019960**

Gynecological simulation allows learners to acquire skills in a non-threatening environment while avoiding harm to patients. Decreased patient availability or limited work hours for residents in gynecology require learners to think creatively and practically on how to optimize their education.

**At 3B Scientific we prepared the below overview to help learners and students choose a gynecological trainer that best fits their needs and requirements.**



	Cervical Exam and Pap Smear Test Simulator	GYN/AID® Gynecological Simulator
Item No.	M-1018643	M-1005789
Removable soft outer skin	-	✓
Palpation of uterus and ovaries	-	only uterus
Bimanual exam	-	✓
Speculum exam	✓	✓
Rectal exam	✓	-
Minilaparotomy	-	-
Uterine sounding	-	✓
Laparoscopic tubal ligation	-	-
Full bladder simulation	-	-
Catheter insertion	✓	-
Vaginal Discharge option	✓	-
IUD insertion	-	✓
Diaphragm sizing and fitting	-	✓
Female condom insertion and removal	-	✓
Interchangeable uteri and cervices	-	✓
Uteri	-	normal anteverted with transparent top, seven uteri with one normal "control" uterus and six with external uterine abnormalities
Cervices	seven cervical conditions: normal, early pregnancy, polyp, early cancer, late cancer, inflammation and dysplasia	two normal, six with cervical abnormalities
Ovaries	-	-
Fallopian tubes	-	two
Carrying case	-	included



MORE INFORMATION ABOUT THE TRAINERS FEATURED IN THIS TABLE ONLINE AT [3BSCIENTIFIC.COM](http://3BSCIENTIFIC.COM) AND ON THE PREVIOUS PAGE



Gynecologic Skills Trainer P91	ZOE® Gynecological Simulator	EVA Gynecological Training Manikin
M-1021592	M-1005797	M-1005723
✓	✓	-
✓	✓	only uterus
✓	✓	✓
✓	✓	✓
✓	✓	✓
-	✓	-
-	✓	-
-	✓	-
✓	-	-
✓	-	-
-	-	-
-	✓	✓
-	✓	-
-	✓	-
✓	✓	-
normal, bicornate, stretched with removable myomas, enlarged uterus	anteverted, retroverted parous, normal with short fallopian tubes, three pregnancy uteri	normal and pregnant 10-week, two adnexal masses
normal nulliparous, normal multiparous, ectropion (erosion), dysplasia, with carcinoma, barrel-shaped carcinoma	five normal, four abnormal	normal, normal parous cervix, with endocervical polyp, with ectropion characteristics, with neoplasia
two normal	two normal	-
eight	ten	-
-	included	included

# PROSTATE AND RECTAL EXAMINATION

## Prostate Examination Simulator

This prostate examination simulator consists of a male abdomen body and 4 different interchangeable prostate glands which can be inserted to allow realistic practice in diagnosis of prostate cancer by rectal examination.

- Stage A Gland: Benign, slightly enlarged, but otherwise normal prostate gland.
- Stage B Gland: A discrete, hard nodule is palpable in the upper right quadrant, simulating a beginning stage of carcinoma.
- Stage C Gland: The spread of carcinoma is demonstrated in this gland. The small nodule has increased in size and has become an external hard mass on the surface of the gland.
- Stage D Gland: This gland is totally replaced with carcinoma. The entire gland will feel hard and irregular.

Comes complete with four glands, hard carrying case, lubricant, cleaner, and teaching guide.

54.5 x 38 x 30.5 cm, 11 kg

**M-1005594**

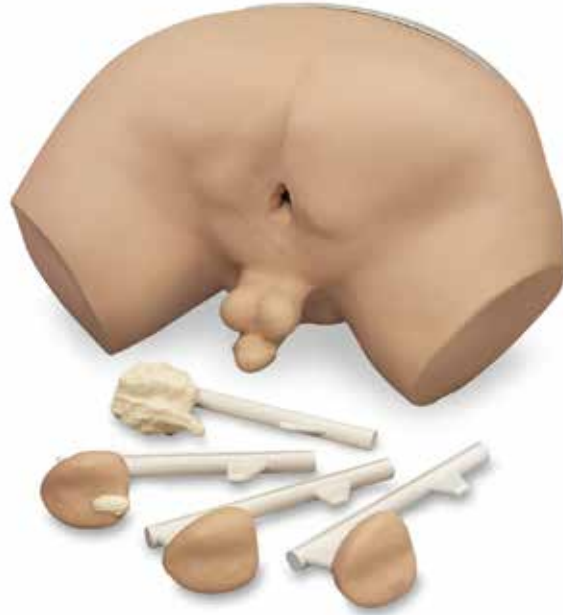

## Replacement parts and consumables:

**REN Cleaner** M-1005776

**Lubricant Set (pack of 6)** M-1017903



PLEASE SEE PAGE 267 FOR OUR PROSTATE MODELS



## Advanced Patient Care Male Prostate Simulator

The simulator features four interchangeable modules, each individually mounted on clear plastic cards for easy placement and removal:

1. A moderately enlarged benign prostate
2. A prostate with two discreet nodules
3. A prostate with an easily palpable large mass
4. A prostate with malignant invasive cancer

Realistic anal opening permits insertion of a lubricated, gloved finger.

Includes instruction manual and soft carrying bag.

**M-1020127**



## No Scalpel Vasectomy (NSV) Model

A compact simulator developed to assist in learning a new method of vas occlusion. To provide realism, the leg stumps are designed to get in the way of the student as the procedure is mastered. Includes two removable scrotal skins and two testicles, two long vas assemblies that can be advanced as needed for NSV exercises, and instructions for use.

30.5 x 30.5 x 32 cm, 2.25 kg

**M-1020196**

➤ AFFORDABLE DIGITAL RECTAL EXAM SIMULATOR FOR CLINICAL SKILL TRAINING!

**3B Scientific® Prostate Examination Trainer, 4 Stages in 1 Trainer P58/1**

Demonstrate and practice digital rectal examinations (DRE) with this affordable skill trainer. The trainer includes 4 different prostates to train professional palpation methods (side position or bent forward) and diagnostic skills associated with rectal examinations.

- Normal prostate
- Advanced prostate carcinoma
- Prostate carcinoma at an early stage
- Benign prostatic hyperplasia (BPH)

The shape, position and consistency of the prostate can be assessed, allowing irregularities, induration and nodes on the otherwise smooth surface of the prostate to be felt. For reference and self-control, the trainer also includes the corresponding transrectal sonographic imaging (transrectal ultrasound, TRUS) for each stage. While in use, the prostate and the sonographic images are hidden and cannot be seen by the trainee. The compact shape of the DRE Trainer makes it easy to store and the perfect skill trainer for every medical simulation lab.

**M-1013116**

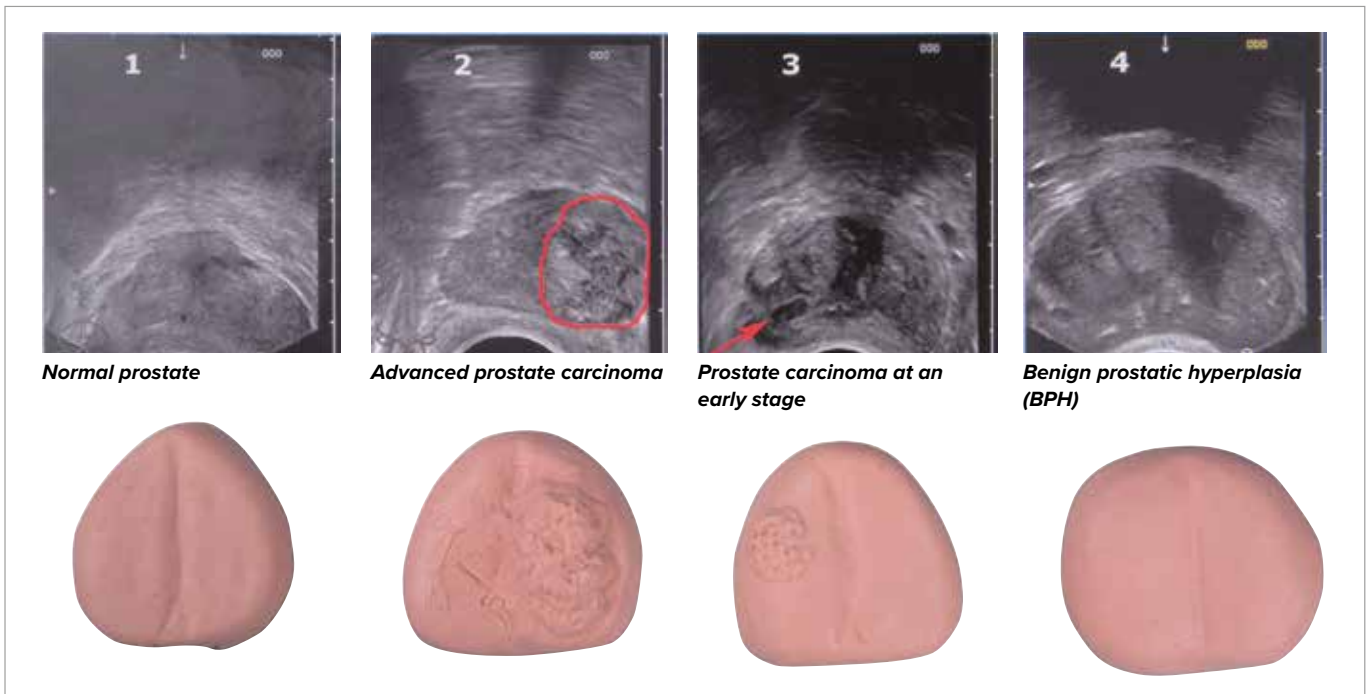

**Normal prostate**

**Advanced prostate carcinoma**

**Prostate carcinoma at an early stage**

**Benign prostatic hyperplasia (BPH)**

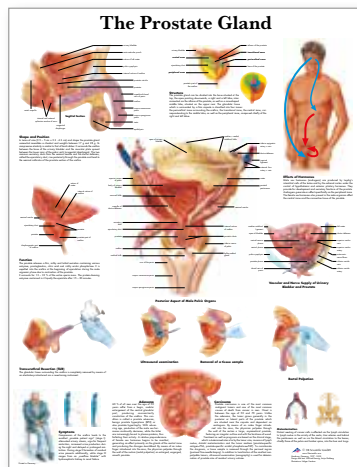

**The Prostate Gland**  
50 x 67 cm, laminated  
**M-1001566**

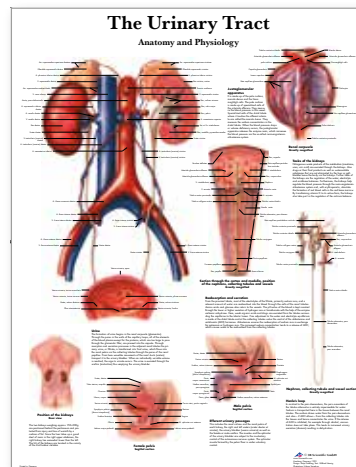

**The Urinary Tract**  
50 x 67 cm, laminated  
**M-1001562**

# PATIENT CARE | ADULT



### 3B Scientific® Patient Care Manikin PRO Build and evaluate advanced patient care and nurse aid competencies with scenario based training!

The patient care manikin simulates an adult, life-size patient, with interchangeable genitals. It can be positioned like a real patient with natural movement of the arms, legs, and joints. It is made of durable, unbreakable, and water-resistant plastics for longevity in the everyday training use.

The PRO version includes removable organs for additional patient care training features like catheterization, enema administration, ostomy care, irrigations and naso-gastric lavage and gavage.

#### **Delivered with:**

Organs (lungs, heart, stomach, bladder and intestinal section), injection pads (upper arm, thigh, and buttocks), intestine tube, catheter, duodenal probe, talcum powder, vaseline, lubricant, amputation stump, inserts with wound depictions (upper arm and thigh), and tools for fitting.

Meets the OBRA requirements of Nurse Aide Training and Competency Evaluation Programs (NATCEP).

174 cm; 15.5 kg delivered with assembly tools

**M-1018816**

### 3B Scientific® Patient Care Manikin BASIC

The 3B Scientific® Patient Care Manikin is also available in a basic version, offering a variety of training possibilities for basic patient care and nurse aide competencies. It comes without organs but can be upgraded to include all training features of the PRO version using the Upgrade Kit available below.

174 cm; 14.4 kg

**M-1018817**



### Upgrade Kit (not shown)

You can easily upgrade the BASIC Patient Care Manikin to the PRO version using this kit. It includes the inner organs and allows for training of catheterization and naso-gastric lavage and gavage.

**M-1000504**

**Patient care training features:**



**Removable organs for advanced training features like catheterization**



**Wound care (laceration and abrasion)**



**Decubitus evaluation and care (stages 2 – 4)**



**Diabetic foot syndrome**



**PRO version delivered with organs**



**Hair care (washing, combing, drying)**



**Wound management (stomie and surgical staple)**



**Simplified assembly**

**➤ PRACTICE BASIC AND ADVANCED NURSING, CLINICAL AND EMERGENCY SKILLS!**

The **BASIC** and **PRO** versions of the patient care manikins offer different training features:

	Patient Care Manikin BASIC	Patient Care Manikin PRO
<b>Item No.</b>	<b>M-1018817</b>	<b>M-1018816</b>
<b>Training features:</b>		
Personal hygiene, cleaning (removable partial prosthesis)	✓	✓
Lifting, mobilization	✓	✓
Bandaging and wound dressing (including stump dressing)	✓	✓
Irrigations (eyes, ears)	✓	✓
Injections (intramuscular and subcutaneous)	✓	✓
Oxygen treatment, artificial respiration	✓	✓
Tracheotomy care	✓	✓
Decubitus evaluation and care	✓	✓
Diabetic foot syndrome care	✓	✓
Catheterization (male and female)	-	✓
Enema administration	-	✓
Naso-gastric lavage and gavage	-	✓
Ostomy care (colostomy)	-	✓
Irrigation (intestines, bladder, vagina)	-	✓

BASIC and PRO consumables and replacement parts	Item No.
Spare amputation stump, right	M-1020714
Spare head, complete	M-1018812
Set of 6 spare injection pads	M-1012754
Spare sealing cap for tracheotomy	M-1020715
Spare chest skin	M-1020707
Spare dental partial prosthesis	M-1020705
Spare forearm with hand	Left M-1020711 Right M-1020709
Spare thigh	Left M-1020712 Right M-1018813
Spare upper arm	Left M-1020710 Right M-1020708
Spare lower leg	Left M-1020713 Right M-1018814
<b>Consumables and replacement parts for PRO</b>	
Spare female genital insert	M-1020723
Spare male genital insert	M-1020724
Spare lung	M-1020718
Spare heart	M-1020719
Spare bladder	M-1020722
Spare section of intestine	M-1020721
Spare stomach	M-1020720



All parts also fit older models – upgrade yours now!  
More information available online at [3bscientific.com](http://3bscientific.com)



**Susie Simon® Patient Care Manikin with Ostomy**

**Full-size dual sex adult manikin with movable joints as well as soft fingers and toes for training of important basic nursing skills such as:**

- Removable upper and lower dentures for oral hygiene
- Realistic eyes for ophthalmic exercises
- Ear canal or otic drops and irrigation
- Mouth, nose, and tracheotomy openings for nasogastric lavage and gavage
- Interchangeable genitalia
- Intramuscular injection site in right and left upper arm and buttock
- Enema administration capability
- Realistic urethral passage and bladder for catheterization exercises
- Vaginal douching and pap smear exercises
- Stomas of a transverse colostomy, ileostomy, and suprapubic stoma
- Bathing and bandaging activity

162.6 x 45.7 cm; 16.5 kg

**M-1005785**

**Consumables and replacement parts:**

<b>Arm Injection Site</b>	<b>M-1005786</b>
<b>Buttock Injection Site</b>	<b>M-1005787</b>
<b>Ileostomy</b>	<b>M-1012749</b>
<b>Ulcerated Foot</b>	<b>M-1019238</b>
<b>Carrying Bag</b>	<b>M-1005788</b>

**Susie Simon® Patient Care Manikin without Ostomy**

All features of M-1005785 but without ostomy. Comes with neck brace, instruction manual and carrying case.

**M-1017535**



**Simple Simon® Patient Care Manikin without Ostomy**

**The full-size adult manikins with movable joints and soft fingers and toes are ideal for training of important basic nursing skills such as:**

- Hair care and surgical draping
- Bathing and bandaging
- Oral and dental hygiene (movable jaw with removable dentures)
- Ophthalmic care
- Ear irrigation and application of otic drops
- IM injection (arm and buttock)

The legs can be removed for compact storage.

Supplied with neck brace.

**M-1005807**

**Simple Susie® Patient Care Manikin without Ostomy (not shown)**

All features of M-1005807 but female appearance and without ostomy. Comes with neck brace, instruction manual and carrying case.

**M-1005803**



**Lower dentures**



**Ear canal**



**Catheterization**



Convenient soft carrying case for all Susie Simon® models M-1005788



For Susie Simon® Nursing Care Simulator M-1005785:



Arm Injection Site M-1005786

Optional Ulcerated Foot M-1019238



➤ PLEASE REFER TO THE COMPARISON TABLE BELOW TO FIND A PATIENT CARE SIMULATOR THAT BEST FITS YOUR REQUIREMENTS



	Susie Simon® Nursing Care Simulator	Susie Simon® Nursing Care Simulator	Simple Susie® Nursing Care Simulator	Simple Simon® Nursing Care Simulator	3B Scientific® Patient Care Manikin PRO
Item No.	without ostomy: M-1017535	with ostomy: M-1005785	without ostomy: M-1005803	without ostomy: M-1005807	M-1018816
Gender	male and female	male and female	female	male	male and female
Wig for hair care	✓	✓	✓	-	✓
Movable jaw with tongue	✓	✓	✓	✓	✓
Removable dentures	✓	✓	✓	✓	✓
Ear irrigation	✓	✓	✓	✓	✓
Nasogastric lavage and gavage	✓	✓	-	✓	✓
Tracheotomy care	-	-	-	-	✓
IM sites at upper arm in buttock	✓	✓	✓	✓	✓
IM site at the upper legs	-	-	-	-	✓
Enema administration	✓	✓	-	-	✓
Catheterization	✓	✓	-	-	✓
Realistic vagina and cervix	✓	✓	✓	-	-
Vaginal douching and pap smear exercises	✓	✓	-	-	-
Sculpted stomas	-	✓	✓	-	✓
Surgical & amputation wound	-	-	-	-	✓
Diabetic foot & decubitus ulcers	-	-	-	-	✓
Laceration wound	-	-	-	-	✓
Detachable and removable internal tanks	✓	✓	-	-	✓
Transverse colostomy, ileostomy, and suprapubic stoma	-	✓	-	-	only colostomy



## KERi™ and GERi™ Nursing Skill Manikins

These manikins feature a life-like range of motion and can be positioned just like a real patient. KERi™ is the age neutral version, while GERi™ simulates an elderly patient with skin wrinkles and folds.

- + Lightweight (13 kg) full-size adult at 146 cm tall
- + Female appearance, easily converts to male with removal of wig and attachment of male genitals
- + Decubitus Sacral Ulcer – Stage 1
- + Dilated and Constricted Pupil Comparison
- + Cancerous Mole Comparison
- + Allow practice of over 35 patient care procedures
- + Reddened Skin Folds

**KERi™**



**GERi™**



*Positioning and transfer techniques*



*Tracheostomy care*



*Blood pressure*

➤ MAKE THE TRAINING EVEN MORE REALISTIC WITH THESE KERI™ AND GERI™ UPGRADE KITS!

**Nursing Care Wound Kit**

This wound kit offers a highly detailed variety of disease, pressure and surgically induced wounds.

**M-1017984**

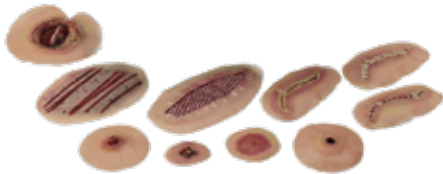

**Auscultation Upgrade Package for GERI™**

The auscultation upgrade torso offers 12 heart and 16 lung conditions controlled by the Smart-Scope™ and remote control. **M-1020045**



**Optional Edema Foot with Deep Tissue Injury**

The foot uses life-like simulated tissue pads to demonstrate stages 1+ through 4+, as well as a non-pitting stage of edema known as brawny edema.

**M-1019744**



**Optional Pressure Ulcer Foot**

Great for reinforcing that pressure ulcers are more likely to appear on various pressure points.

**M-1017985**

Item No.	Basic		Complete		Advanced		Auscultation	
	KERI™ M-1020187	GERI™ M-1005620	KERI™ M-1013742	GERI™ M-1005597	KERI™ M-1017567	GERI™ M-1005606	KERI™ M-1020147	GERI™ M-1020146
Skin inspection and care	✓		✓		✓		✓	
Bandaging	✓		✓		✓		✓	
Washing	✓		✓		✓		✓	
Denture Placement	✓		✓		✓		✓	
Hearing aid placement	✓		✓		✓		✓	
Ear and eye irrigation	✓		✓		✓		✓	
Ostomy and tracheostomy care	✓		✓		✓		✓	
Positioning and transfer techniques	✓		✓		✓		✓	
Pericare	✓		✓		✓		✓	
Intramuscular injections	✓		✓		✓		✓	
Gastrostomy	-		✓		✓		✓	
Pap smears and douching	-		✓		✓		✓	
Enema administration	-		✓		✓		✓	
Prostate exam	-		✓		✓		✓	
Urinary catheterization	-		✓		✓		✓	
Nasogastric tube placement	-		✓		✓		✓	
IV insertion	-		-		✓		✓	
Blood pressure monitoring	-		-		✓		✓	
Recognition of heart sounds	-		-		-		✓	
Recognition of lung sounds	-		-		-		✓	

### Clinical Chloe™ Patient Care Simulator with Sculpted Stomas

*The basic version for nursing care training allows you to practice:*

- General patient care
- Injections (IM injection sites in arm, thighs, and buttock)
- Breast palpation
- Airway management
- GYN Training (vaginal douching and pap smear exercises)

**M-1017542**



### Clinical Chloe™ Advanced Patient Care Simulator

*In addition to the basic version, the advanced version features:*

- CPR monitored by included
  - OMNI® Controller
  - Injections (advanced training arm and hand for IV, IM, and subcutaneous techniques)
- Carrying bag and instruction manual included. Detachable and removable internal tanks, latch provides secure seal between ostomies and internal tanks.

**M-1017574**

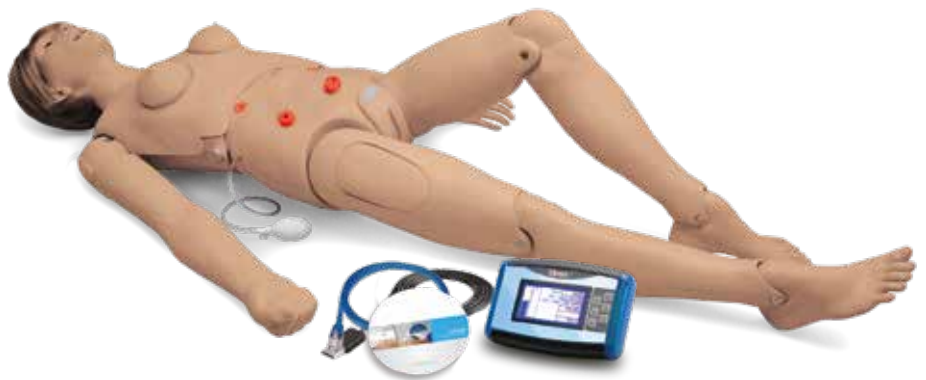

### Code Blue® Multipurpose Patient Care and BLS Manikin

Simulator with non-intubatable disposable Airway.

*This adult manikin features training of:*

- Oral and denture hygiene
- IM (arm and buttock), IV and subcutaneous injection
- Ostomy care
- Naso-gastric lavage and gavage
- Male and female catheterization
- Enema administration
- Vaginal douching and pap smear exercises
- Palpable prostate and breast
- Amputation stump
- 2 decubitus ulcers
- Eyes open and close (one pupil is dilated)
- Regular or counter pulsation CPR
- Mouth to mouth resuscitation
- Palpable carotid pulse

Omni™ Code Blue® Pack included. Also supplied with ten disposable one-piece airways, neck brace, and carrying bag.

**M-1005782**



## NEW! Bowel Care Trainer P16

High quality life-size bowel care trainer for realistic enema and bowel care management and interventions training. Improve the hospital patient care training in order to reduce the risk of complications associated with management of lower bowel dysfunction and ensure patient safety.

This high quality bowel care trainer simulates the buttock of a patient with femoral stumps, anus and bowel in pre-positioned left lateral recumbent position. The upper buttock is soft and flexible to be most realistic; the trainee has to lift it to gain access to the anus.

### Technical features of the Bowel Care Trainer P16:

- Supports the insertion of CH16 to CH40 catheters and balloon rectal tubes
- The different Digital Rectal Inserts are made of SKINlike™ sturdy silicone to simulate human skin and tissue haptic during DRE and DRS
- Anus stays closed and remains impenetrable after the removal of the catheter due to the high quality of the insert material
- Secure fluid reception reservoir system ensures portability, impermeability, security
- Administer standard enema solutions without risk up to a volume of 2 liters
- Fluid can be drained into the reception reservoir or directly into a nearby sink or canister
- Optimized design to enable a quick and simple installation for each procedure
- Easy to clean

### Delivery content:

- Bowel Care Trainer P16 by 3B Scientific
- Secure fluid reception reservoir
- 1 DRE, 1DRS and 1 DRF insert
- 2 magnetic 3D anatomical models of Hemorrhoids
- Artificial solid stools (Bristol Stool Chart type I)
- Solid (150 g) and soluble (60 g) stool powder, artificial
- Dosage spatula and cup for stool preparation
- Bottle of concentrate blood (250 ml), artificial
- Blood pipette injector
- Talcum powder (100 g), Vaseline
- Plastic storage box for consumables
- Soft carrying bag



### Dimensions and weight:

3,8 kg; 55 × 35 × 32 cm

**M-1022519**

### Replacements and Consumables:

**Artificial Soluble Stool Powder (60 g)**  
**M-1022521**

**Artificial Solid Stool Powder (1 kg)**  
**M-1022522**

**Digital Rectal Inserts Replacements Set**  
**M-1022523**

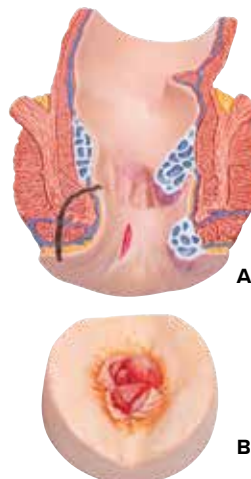

**Contains two 3D (three dimensional) anatomical didactic models of hemorrhoids to facilitate the explanation of complication or contraindication:**

- A rectum frontal section with hemorrhoids, anal fissures and fistulae
- B external view with swollen anal prolapse and hemorrhoid knots

The 3D models are attached to the model with magnets so they can be passed from student to student during class.



**Enema Administration Simulator**

Each student can realistically practice administering an enema using this life-like model. The upper buttock is flexible so that the trainee must raise the buttock in order to locate and make insertion into the anus. The simulator features a one quart fluid reservoir that is adequate for most demonstration and practice purposes. For large groups, a drain tube is provided so that the fluid can be drained directly into a large container or sink for continuous use. Includes a hard carrying case, enema administration set, and teaching guide.

**M-1005626**

**Consumables and replacement parts:**

- Highly-concentrated Lubricant**      **M-1005629**
- Fluid Administration Set**            **M-1013186**
- REN Cleaner**                              **M-1005776**



**Ostomy Care Model**

This BIOlike™ life-size model contains four stomas that can be lubricated and dilated with an inserted finger. The model may be washed, taped, bandaged, and fitted with ostomy bags. Comes with lubricant, draping sheet, and carrying case.

33 x 46 cm; 4.55 kg  
**M-1005570**



**Ostomy Care Simulator**

Reproduction of an abdomen showing the anatomy of both a colostomy and ileostomy to provide life-like functions and appearance. Dilation of the stomas can be demonstrated and practiced, along with application of post-operative and permanent ostomy bags. The colostomy can be irrigated. Drainage and excretion at the ileostomy (water) and colostomy (simulated stool) can be pumped by syringes. Delivered with simulated stool and carrying case.

45.5 x 45.5 x 30.5 cm; 11 kg  
**M-1005591**

**> IMPACTS VISION, HEARING, GRIP STRENGTH AND PHYSICAL ABILITIES**

**New Aged Simulation**

In order to better understand your patients, walk a mile in their shoes. There is no better way to create empathy than to actually experience the physical challenges aging patients face on a daily basis.

**Easy to put on and adjust!**

The body suit is worn like an overall, the different restrictions can easily be adjusted to change the range of motion, and even simulate hemiparesis.

**Different sizes available!**

**Size S (145 – 155 cm)**  
**M-1020111**

**Size L (165 – 175 cm)**  
**M-1021894**

**Size M (155 – 165 cm)**  
**M-1020112**

**Size XL (175 – 185 cm)**  
**M-1021895**



# PATIENT CARE

## CHILD AND INFANT



### Male Baby Care Model

**Very useful for pre-birth courses! This true-to-life model of a newborn male baby is suitable for a variety of different training procedures:**

- Changing the baby's nappy
- Feeding and administration of medicine
- Obtaining urine specimens
- Dressing and undressing
- Picking up, carrying, and positioning of a baby (head tilts backwards if the baby is incorrectly held)
- Washing, cleaning of mouth, eyes, ear and nose
- Taking a rectal temperature
- Examination of fontanelles and testicles

52 cm; 2.7 kg

**M-1000506**



### 3B Scientific® Pediatric Nurse Training Baby, Newborn

Practice paediatric nursing care on a realistic newborn manikin.

This advanced and incredibly realistic manikin with male and female features includes internal organs (heart, lung, intestine system, stomach, and bladder), interchangeable genital organs and fully movable head, arms and legs.

**It allows the trainees to easily practice basic care like washing, dressing and umbilical care, as well as the following pediatric nursing care options:**

- Suctioning of nasopharynx
- Tube Insertion
- Insertion and care of a tracheal cannula
- Intramuscular and subcutaneous Injections
- Obtaining urine specimens with a urine collection bag
- Bladder catheterization, male and female
- Taking a rectal temperature
- Enema insertion

52 cm; 2.8 kg

**M-1000505**

### Life/form® Micro-Premie Simulator

This 25-week ELBW (Extremely Low Birth Weight) neonate is the smallest and most realistic pre-term infant available. Delivery of an ELBW infant remains to be an extreme medical emergency, requiring specialized techniques that can be trained with this outstandingly realistic simulator. The baby can be ventilated and will accept a functional ET tube, NG tube, umbilical catheter, and IV line, as well as a non-functional chest tube and stomas.

**Delivered with:** diaper, hat (colour may vary), umbilicus, omphalocele, neural tube defect, bilateral chest block, unilateral chest block, airway, 3 cc syringe, 25-gauge butterfly needle, lubricant, blood powder, bulb and tube assembly.

**M-1020812**



**Delivery Content**



**Birth Defects**



**Umbilicus**



MORE BABY CARE MODELS IN PARENT EDUCATION ON PAGE 287

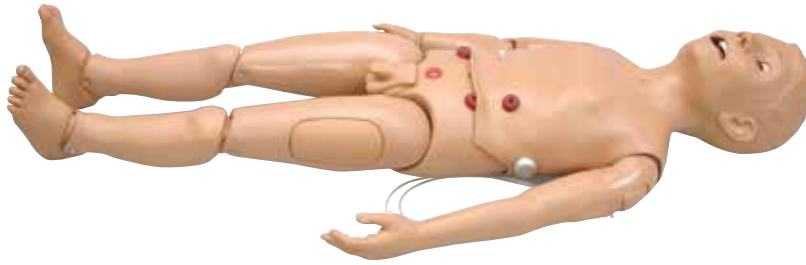

**Multipurpose Patient/Emergency Pediatric Simulator**

This manikin of a 5-year old is ideal for training pediatric patient and nursing care as well as CPR. Its realistic face skin and molded hair, the articulating joints, and realistic hands and feet make for an impressive training experience.

**Training Features:**

- Ophthalmic procedures
- Realistic chest cavity, with realistic internal organs for unparalleled
- CPR performance
- Bathing and bandaging activity
- Place nasal and oral gastric tubes
- Lavage/gavage
- G-tube placement
- Stomas for ileostomy, colostomy, and suprapubic exercises
- Male and female catheterization
- Enema administration
- Placement of rectal suppositories
- IM injection sites in deltoid and upper thigh

**Emergency Care Features:**

- Oral, nasal, and digital intubation
  - Place OP/NP tubes
  - Right/left mainstem bronchi
  - Suctioning
  - BVM
  - Chest compression/rise
  - Intraosseous infusion
  - IV arm with variable, palpable pulses
- Supplied with T-shirt and shorts, soft carrying bag, and instruction manual.

**M-1017564**



**Mike & Michelle® Child Patient Care Manikin**

This manikin simulates a 5-year old child with rotatable arms and legs (jointed elbows and knees) and articulating head. Supplied with T-shirt, shorts, neck brace and carrying bag.

**It allows training of basic and advanced pediatric patient care procedures such as:**

- Bathing and bandaging
- Ophthalmic exercises
- Oral and dental hygiene (articulating jaw with teeth and tongue)
- Tube feeding and gastric suction
- IM injection (upper thigh and deltoid)
- Tracheotomy care
- Male and female catheterization
- Enema administration

**M-1005808**



**Life/form® Special Needs Infant**

This newborn-size infant allows health care facilities and medical staff to teach procedures for special needs infants. The simulator was developed for a wide range of training, including for beginning nursing students.

**Procedures that can be practiced include:**

- Tracheostomy care (lavage and suctioning)
- Gastrostomy cares (lavage and gavage)
- Nasogastric care (placement, lavage, gavage, and suctioning)
- Urethra catheterization (insertion, placement, and care)
- Colostomy stoma (basic care purposes only)

**female M-1018099**

**male M-1018198**



➤ PLEASE REFER TO THE COMPARISON TABLE BELOW TO FIND A PEDIATRIC CARE SIMULATOR THAT BEST FITS YOUR REQUIREMENTS

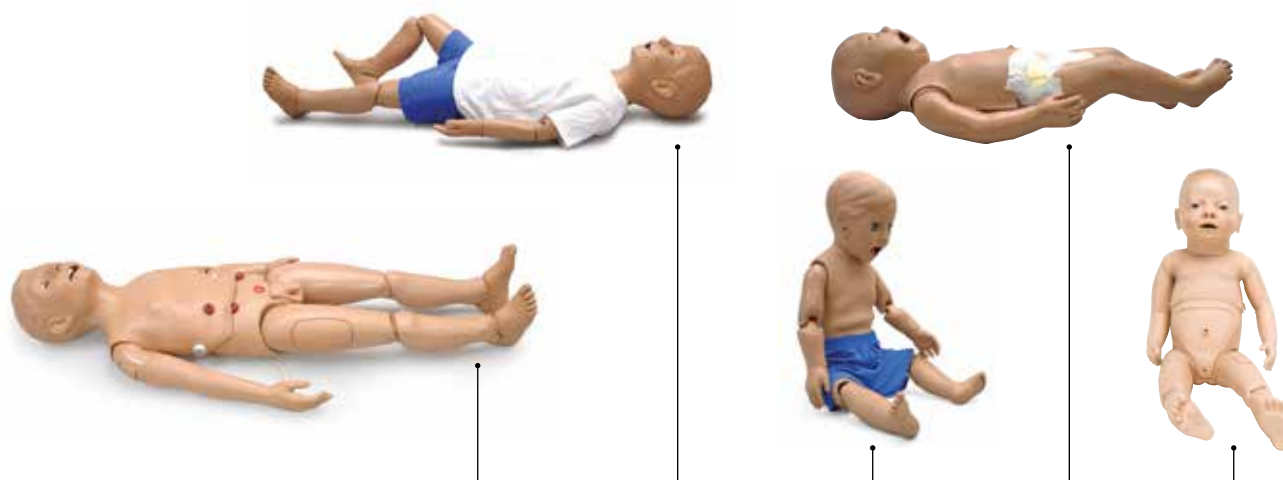

	Multipurpose Patient Care Simulator	Nursing Care Patient Simulator	Mike® and Michelle® Pediatric Care Simulator	Susie Simon® Nursing Care Newborn Patient Simulator	3B Scientific® Pediatric Nurse Training Baby
Item No.	M-1017564	M-1005808	M-1005804	M-1005802	M-1000505
Age	5-year old	5-year old	1-year old	newborn	newborn
Ear irrigation	✓	✓	✓	✓	✓
Realistic chest cavity for CPR	✓	-	-	-	-
Bathing and bandaging	✓	✓	✓	✓	✓
Place nasal and oral gastric tubes	✓	✓	✓	only nasal	✓
Lavage and gavage	✓	-	-	-	✓
G-tube placement	✓	-	-	-	-
Tracheotomy placement	-	✓	✓	-	-
Stomas	✓	-	-	-	-
Interchangeable genitalia & Catheterization	✓	✓	✓	✓	✓
Enema administration	✓	✓	✓	✓	✓
Placement of rectal suppositories	✓	-	-	-	-
IM sites	✓	✓	✓	✓	✓
Intubation	✓	-	-	-	-
Place OP/ NG Tubes	✓	-	-	-	✓
Suctioning	✓	-	-	-	✓
BVM and chest rise	✓	-	-	-	-
IO infusion & IV arm	✓	-	-	-	-
Heel stick and finger prick technique	-	-	-	✓	-
Carrying bag	included	included	included	included	included



VISIT [3BSCIENTIFIC.COM](http://3BSCIENTIFIC.COM) TO FIND OUT MORE ABOUT PRODUCTS FEATURED IN THIS TABLE



# WOUND CARE AND BANDAGING

➤ REALISTIC PRACTICE OF WOUND CARE!



### 3B Scientific® Trainer for Wound Care and Bandaging Techniques

Using this high quality simulator, students learn how to care correctly for their patients' wounds and can practice a wide range of dressing and bandaging techniques. The life-like skin reacts realistically to adhesives and bandages, so students can practice in conditions as close to reality as possible. Given the flexible structure of the material, students can practice putting on and changing bandages and dressings in realistic conditions.

The following 13 wounds and drain systems resulting from surgical procedures and injuries are represented realistically on the torso with already applied wound closures (staples and sutures):

- Wound after a thyroidectomy
- Wound after a sternotomy (with drain)
- Wound after a mastectomy (with drain)

- Wound after a splenectomy (with drain)
- Wound after a thoracotomy (pneumonectomy)
- Wound after a median laparotomy (e.g. cystectomy)
- Wound after an appendectomy
- Wound after a Pfannenstiel incision (e.g. C-section or abdominal hysterectomy)
- Wound after a laminectomy
- Wound after a nephrectomy (side incision)
- Wound after an amputation (leg stump)
- Colostomy
- Decubitus (Stage II)

Easy to clean and store, includes carrying bag.

**M-1020592**



### 3B Scientific® Decubitus Simulator

**With this realistic and affordable wound care trainer, nursing and medical students will be able to:**

- Visualize and understand the differences in decubitus wounds
- Practice wound cleansing
- Practice bandaging techniques with multiples dressings methods
- Improve the classification, staging, and their wound assessment skills
- Measure wound length, depth, undermining, and tunneling

**3B Scientific® Decubitus Trainer display the following pressure ulcers:**

- Decubitus Stage I (greater trochanter): 6 x 3 cm
- Decubitus Stage II (buttocks): 7 x 6 cm
- Decubitus Stage III (buttocks): 6.5 x 7.5 cm
- Decubitus Stage IV (greater trochanter): 10 x 4.5 cm

The realistic texture and flexibility of the skin offer a realistic haptic and optic, and therefore promote effective training. Each wound has been colored exactly as seen on a real patient.

Delivered with carrying bag.

**M-1019698**

### Life/form® First Aid Arm

Students will need to react just as in an actual emergency and select the appropriate method to control bleeding and treat the wound. Synthetic blood can be made to flow from either the cut on the forearm or from the severed thumb, or from both at the same time. The severed thumb allows training in proper care and handling of separated body members.

- Regulate rate of bleeding and create venous or arterial flow
- Blood returns to collection tray for reuse
- Pressure points function realistically at wrist and upper arm

Includes vinyl arm with wound, severed thumb, collection tray, arterial pulse bulb, venous supply bag, one quart of Life/form® blood, teaching guide, and hard carrying case.

**M-1013748**

### Consumables and replacement parts:

<b>Artificial Blood</b>	<b>M-1005611</b>
<b>Venous Blood</b>	<b>M-1005691</b>
<b>Fluid Supply Stand</b>	<b>M-1005692</b>
<b>Fluid Supply Bag</b>	<b>M-1005693</b>

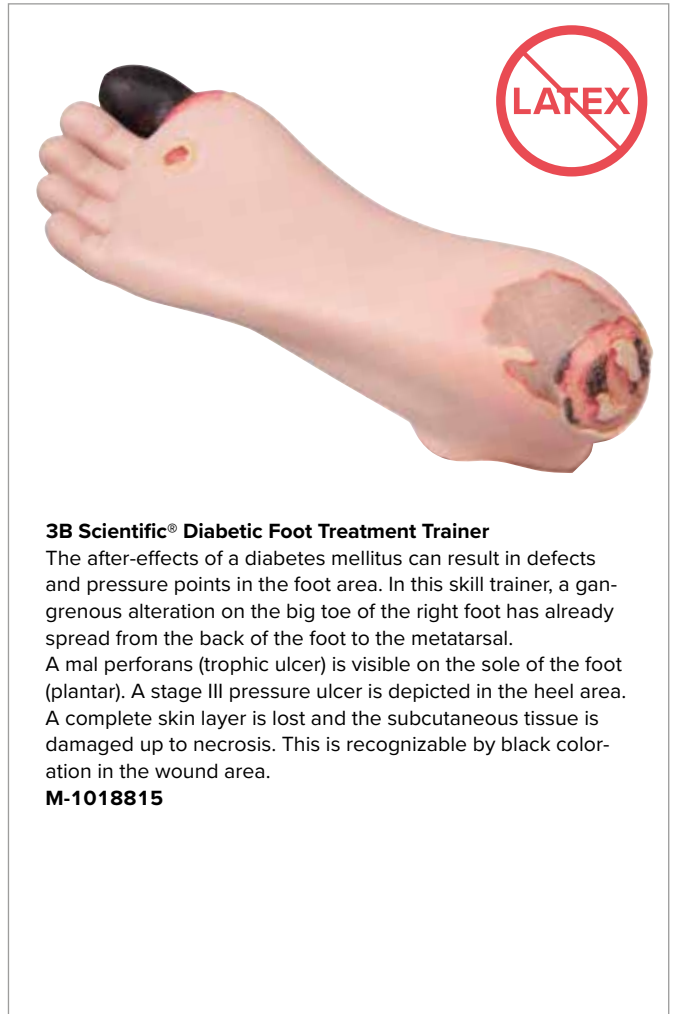

### 3B Scientific® Diabetic Foot Treatment Trainer

The after-effects of a diabetes mellitus can result in defects and pressure points in the foot area. In this skill trainer, a gangrenous alteration on the big toe of the right foot has already spread from the back of the foot to the metatarsal. A mal perforans (trophic ulcer) is visible on the sole of the foot (plantar). A stage III pressure ulcer is depicted in the heel area. A complete skin layer is lost and the subcutaneous tissue is damaged up to necrosis. This is recognizable by black coloration in the wound area.

**M-1018815**



# CATHETERIZATION

➤ AFFORDABLE SKILL TRAINER FOR REALISTIC MALE AND FEMALE URINARY CATHETERIZATION!

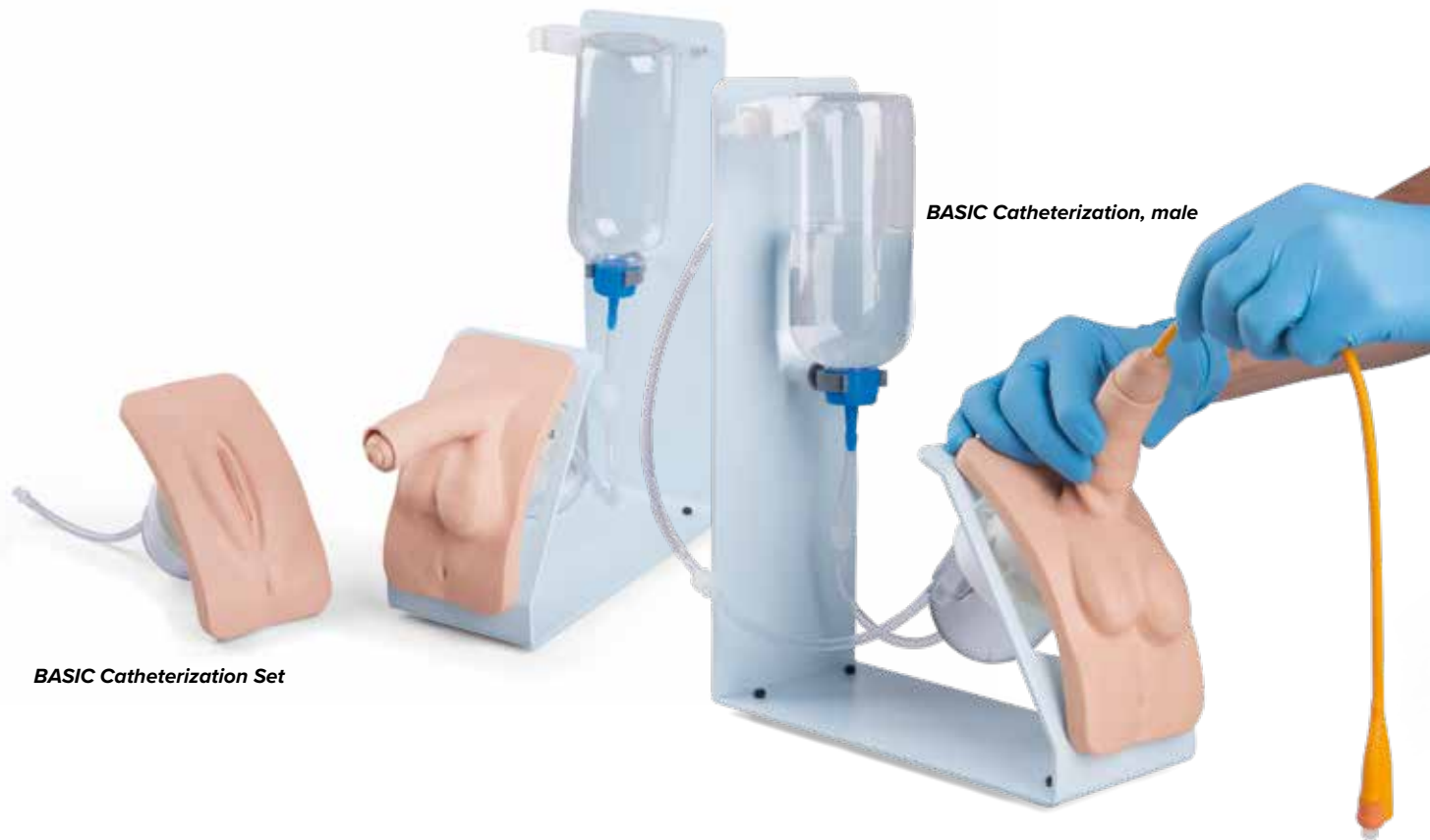

**BASIC Catheterization Set**

**BASIC Catheterization, male**



## Catheterization Simulator

- + Magnetic easy-to-change genital inserts
- + Easy to clean and maintain
- + Transparent bladder so you can observe the success of the procedure
- + Level of difficulty adjustable

### **For realistic training of male and female catheterization:**

- Life-like resistance for a realistic training effect
- 3 levels of adjustable urethral narrowing
- Soft and movable foreskin and labia

### **Immediate learning effects:**

- Check the positioning of the catheter through the transparent bladder
- Fluid will flow if the catheterization has been carried out correctly
- In the PRO version, the abdominal wall can be removed so that the process can be directly observed

With the catheterization trainer, both male and female catheterization can be demonstrated, practiced and assessed. The interchangeable genitalia are anatomically correct and made from realistic material. The foreskin and labia are soft and pliable, so that all necessary steps (like disinfecting the area) can be practiced.

### **Adjust the levels of difficulty:**

On the male insert, three different levels of urethral narrowing can be set. In the narrowest setting, catheterization is not possible, leading to the conclusion that a suprapubic catheter is needed. A suprapubic catheter is already in place on which correct care and cleaning can be practiced.

### **Additional benefits:**

- Non-slip feet
- Easy to clean, all parts can be taken apart easily
- Magnetic connectors for quick and easy set-up and dismantling

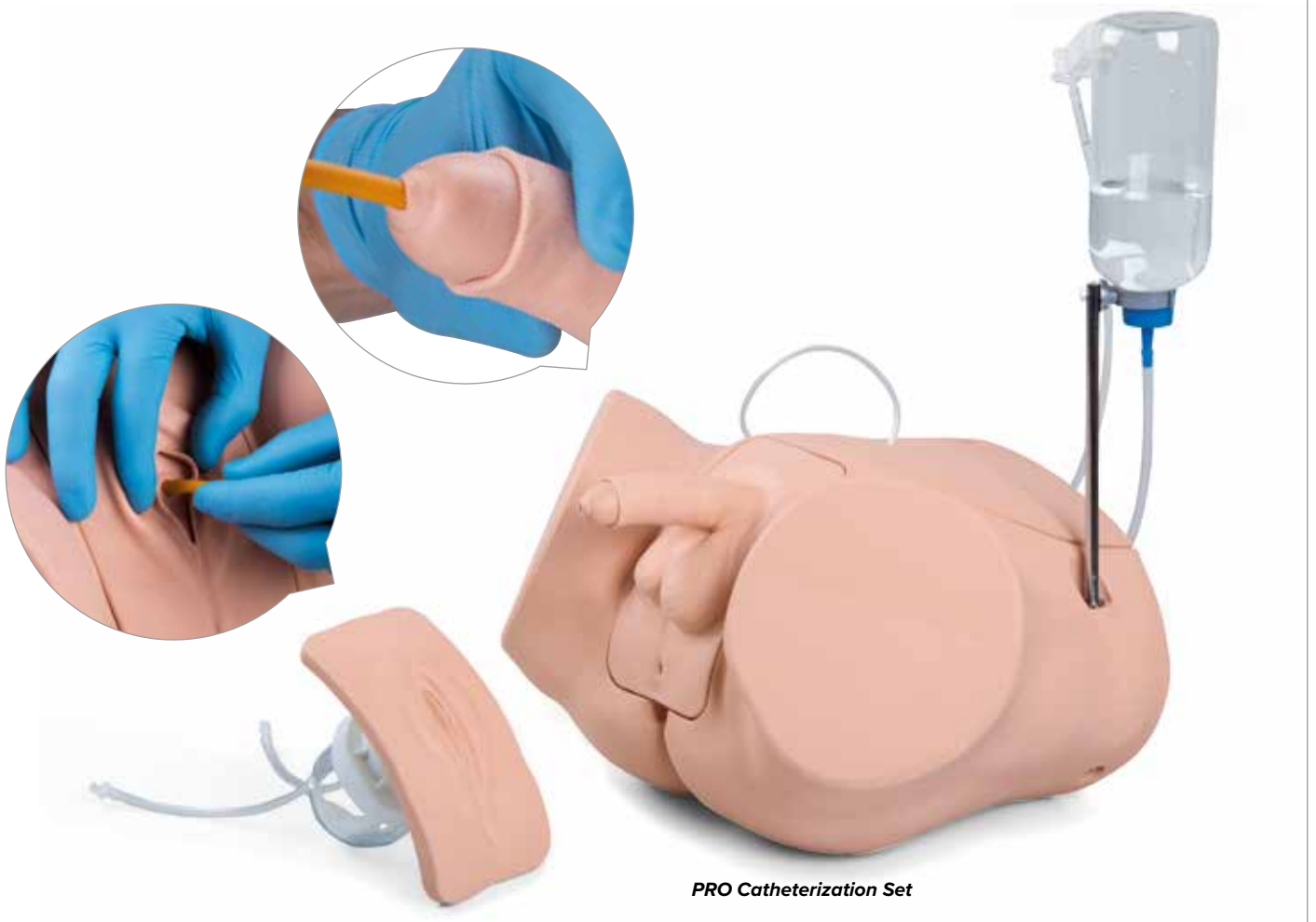

**Available in these versions:**

**3B Scientific® BASIC Catheterization Set**

- Stand with magnetic connections for genital inserts
- Male and female catheterization set with transparent bladder
- Bottle and tube connectors

**BASIC Catheterization Set** M-1020842

**BASIC Catheterization, male** M-1020232

**BASIC Catheterization, female** M-1020231

**3B Scientific® PRO Catheterization Set**

- Realistic lower abdominal model
- Male and female catheterization set with transparent bladder
- Bottle and tube connectors
- Carrying bag

**PRO Catheterization Set** M-1020843

**PRO Catheterization, male** M-1020230

**PRO Catheterization, female** M-1020229

**Consumables and replacement parts:**

**Catheterization insert only, male** M-1020234

**Catheterization insert only, female** M-1020233



*The PRO version also contains a suprapubic catheter on which care and cleaning can be practiced.*



*The three different grades of urethral narrowing can be easily adjusted manually at any time.*

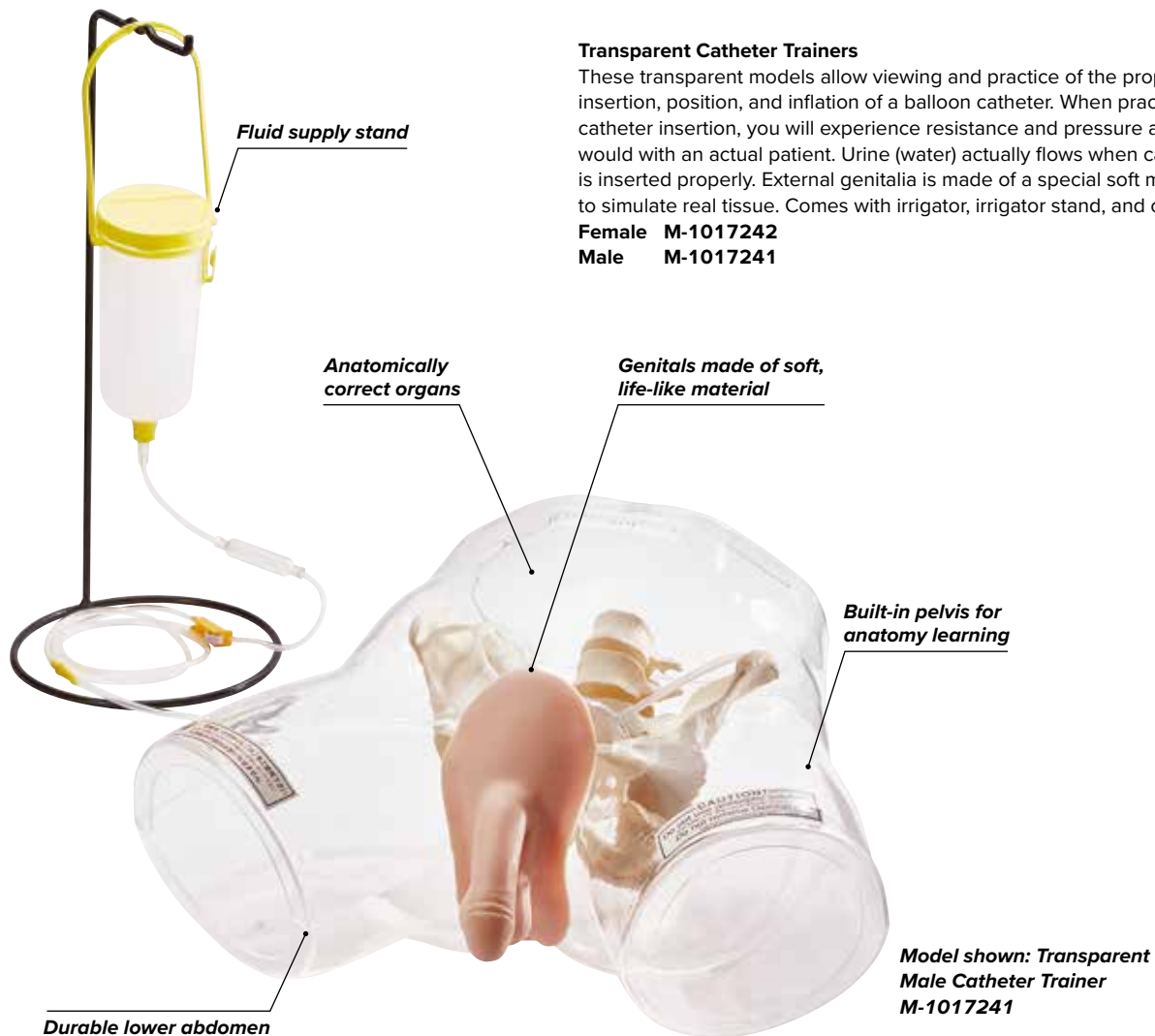

**Transparent Catheter Trainers**

These transparent models allow viewing and practice of the proper insertion, position, and inflation of a balloon catheter. When practicing catheter insertion, you will experience resistance and pressure as you would with an actual patient. Urine (water) actually flows when catheter is inserted properly. External genitalia is made of a special soft material to simulate real tissue. Comes with irrigator, irrigator stand, and case.

**Female M-1017242**  
**Male M-1017241**

**Heart Catheterization Simulator**

This simulator is ideal for practicing central venous catheterization. All appropriate landmarks are palpable for realistic identification of insertion sites. Remove skin to reveal location of veins, arteries, and other landmarks. Artificial blood flows from needle to provide confirmation of proper needle location. Venous catheters can be snaked into place once the introducer is properly inserted. Includes fluid supply bags, replaceable skin, tubing sealant, needles, one quart of blood, and teaching guide in a hard carrying case. Fluid supply stand not included.

71 x 43 x 25 cm

**M-1017260**



PLEASE VISIT [3BSCIENTIFIC.COM](http://3BSCIENTIFIC.COM) FOR A FULL LIST OF AVAILABLE CONSUMABLES AND REPLACEMENT PARTS

# CENTRAL LINE- AND PORT MANAGEMENT



## Chester Chest™

Chester Chest™ has been an industry standard since 1986 for the teaching of central line care. Chester Chest™ makes it possible to teach and practice the infusion, withdrawal, care, securement and dressings of multiple vascular access lines.

- Successful access is confirmed by a blood return
- Fluid can be infused and blood withdrawn from all the lines
- Can be used in upright and supine positions

## Chester Chest™ with Standard Arm M-1021821

## Standard Arm for Chester Chest™ M-1021823

## Chester Chest™ with Advanced Arm M-1009801

## Advanced Arm for Chester Chest™ M-1005840

## Peter PICC Lines Simulator

It has become critical in controlling costs to ensure that the competency of all IV staff is assessed, maintained, demonstrated, and improved continually. Vascular access simulators are acknowledged as the most efficient way to teach staff and assess competency. Validate and train the knowledge and skills needed for Peripherally Inserted Central.

### Catheter (PICC) lines with this simulator:

- Model presented in supine position with arm at 90-degree angle to body
- Movable chin simulates occlusion of jugular
- Anatomically correct cephalic, basilic, and median basilic veins, jugular, subclavian, and superior vena cava

**M-1017957**



## › TEACH HEALTHCARE STAFF THE CARE AND USE OF TWO DIFFERENT TYPES OF CATHETERS



## Deluxe Venous Access Device Model

Reproduction of a male chest mounted on a collapsible easel designed for training in vascular access device maintenance and dressing central venous catheters. Made of skinned, lightweight urethane foam, this model may be washed with soap and water or with antiseptics.

- Bilateral subclavian venous catheter connections
- Implanted PORT-A-CATH
- Both catheters may be flushed with water
- Accepts betadine and most other antiseptics
- Replaceable chest module

53 x 38 cm; 4.5 kg

**M-1005563**

# SUTURING

› APPLY THE WOUND ANYWHERE ON THIS TRAINER AND PRACTICE SUTURING HUNDREDS OF TIMES!

## 3B Scientific® Suture Training Arm

The realistic anatomy of the 3B Scientific® Suture Training Arm offers the possibility for suture training that is a lot more complex than with regular suture pads. Given its movable hand and fingers, even challenging sutures in hard to reach places like between the fingers can be practiced. Both the skin and the subcutaneous tissue are represented for a life-like suturing experience.

Additionally, each wound can be sutured several times, making this trainer very economic and suitable even for larger skill training classes.

- Movable fingers for suture training of challenging wounds between fingers
- Skin and subcutaneous tissue differentiated for realistic suture experience
- Wounds can be inflicted by instructor anywhere on the training arm
- For surgical staples procedure

**M-1020904**



## Suture and Stapling Practice Trainers – Leg

Made with a soft vinyl skin over a core of stitchable foam to provide a life-like suturing experience. Soft and pliable for easy sewing, the skin is tough enough that sutures will not pull out when tightened. The unit is provided with three wounds. Conservatively, more than one hundred cuts can be made on the trainer and each of these cuts can be sutured several times.

- Realistic skin texture with wrinkles, pores, and visible toeprints
  - Disposable limbs provide hundreds of suturing experiences before wearing out
- Trainer comes complete with a starter package of sutures and instruction booklet.

**M-1005683**





**Life/form® Interactive Suture Trainer**

The trainer attaches easily to an arm, leg, or hip, allowing practice of suturing techniques in addition to essential communication and patient interaction skills. This convenient, cost-effective kit offers practice at all skill levels, including tying knots, placement of staples, and suturing both superficial and deep wounds. Wounds automatically open when cut. Includes suture pad, attachable pad base with straps, needle holder, suture scissors, tissue forceps, scalpel, soft carrying case, nylon suture, instrument case and instruction manual.

**M-1018196**



**Life/form® Suture Kit**

Train incisions and determining the depth of suturing and the technique to be used. Practice and demonstrate tying knots, stapling and placement of staples, use of surgical glue, suturing deep tissue, and suturing subcutaneous tissue. Features epidermis, dermis, fascia, fat, and muscle layers. The skin will allow placement and closure of superficial sutures. Includes suture pad, tray to hold pad, durable carrying case, needle holder, suture scissors, tissue forceps, scalpel, nylon suture and small case to hold the instruments.

**M-1017981**



**Surgery Skill Trainer**

The Surgery Trainer allows open surgery practice and offers an advanced skills capability for cut and suture practice. The single sided skin pad and a piece of abdominal bowel (which can be anastomosed) are replaceable.

**M-1005144**

**Consumables and replacement parts:**

**Two Layered Abdominal Bowel, 3 x 27 cm**

**M-1005149**

**Two Layered Abdominal Bowel, 2 x 9 cm**

**M-1005146**

**Single-Sided Skin Pad, 11 x 8 x 2 cm**

**M-1005145**

**Double-Sided Skin Suture Pad**

**M-1005133**



**Skin Suture Trainer**

A great low cost way to practice surgical opening and closing techniques.

- Economical reversible pad
- Designed to make complex incisions such as flap and dog turn suturing more realistic
- A sub-dermal layer is present to make secure intradermal sutures
- Base has suction feet to enable slip free use 11 x 14 cm

**M-1005134**

**Consumables and replacement parts:**

**Double-Sided Skin Suture Pad**

**M-1005133**



**Suture Practice Trainer**

This is a basic skill trainer which offers a limited facility for knot tying. The foam can be turned over and or replaced.

- Rubber suction feet
- Washable parts
- Sutures and string not provided

**M-1005147**

**Consumables and replacement parts:**

**Foam Pad M-1005148**

# BLOOD PRESSURE

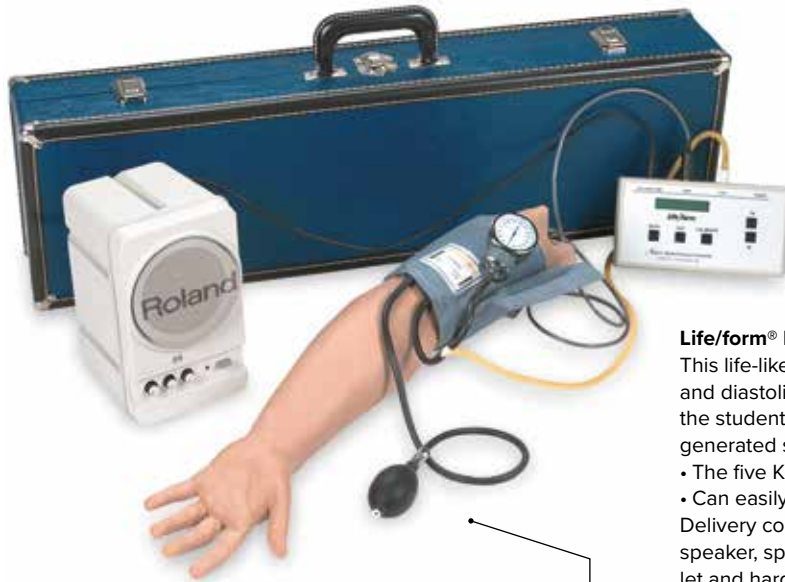

## Life/form® Deluxe Blood Pressure Arm with Speaker

This life-like simulator allows the presetting of values for both systolic and diastolic pressures. The instructor can unfailingly know whether the student has performed the procedure accurately. All electronically generated sounds are digitally recorded.

- The five Korotkoff phases can audibly be discerned
  - Can easily be calibrated for use with any sphygmomanometer
- Delivery content includes the Life/form® Arm Replica with embedded speaker, sphygmomanometer, electronic control unit, instruction booklet and hard carrying case. Does not include a stethoscope.

**115 V M-1005622**

**220 V M-1005623**

## Consumables and replacement parts:

**Amplifier/Speaker System 110 V M-1019721**

**Amplifier/Speaker System 220 V M-1020046**

**Electronic Control Unit M-1019718**



## Life/form® Blood Pressure Cuff Replacement

Replacement for use with Blood Pressure Simulators M-1005621, M-1005622 and M-1005623.

**M-1020960**

## Life/form® Blood Pressure Simulator

This Blood Pressure Simulator teaches physical assessment and helps resolve the uncertainties common in teaching students to take blood pressure. This life-like simulator allows the presetting of values for both systolic and diastolic pressures. Provides an excellent means to practice listening to and distinguishing blood pressure sounds prior to actual clinical experience. It is possible to audibly discern the five Korotkoff phases.

Includes the Life/form® Blood Pressure Arm with embedded speaker, sphygmomanometer, electronic control unit, instruction manual, and soft carrying case.

**M-1005621**

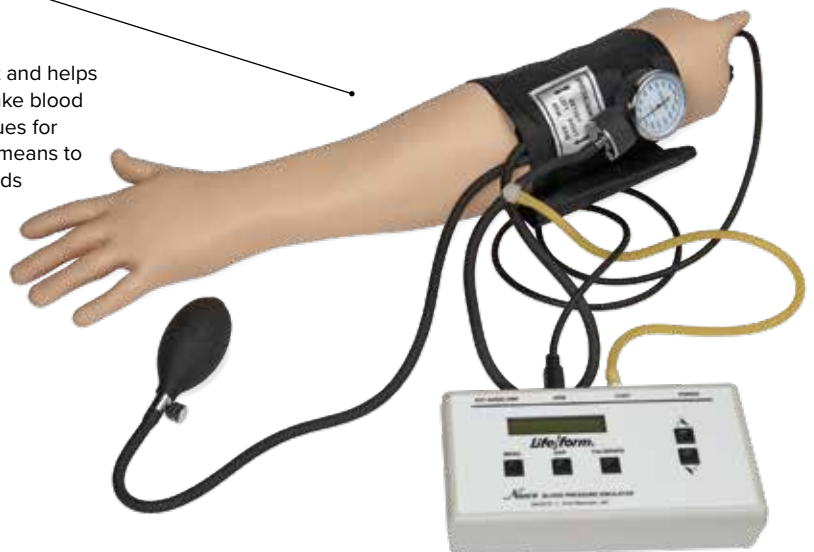

**Blood Pressure Training System with Speakers and Omni®**

The Blood Pressure Training Systems include a full-size adult left arm that may also be attached to any Gaumard® adult manikin. These versatile training tools were developed to assist health professionals teach the processes and skills required to perform blood pressure auscultation procedures and techniques.

Systolic and diastolic pressures, auscultation gap and pulse rate are adjustable. Cuff pressure can be seen on a display. International power supply 100 to 240 VAC. Soft carrying bag and instruction manual.

89 x 38 x 48 cm; 3.5 kg  
**M-1019813**

**Blood Pressure Training System with Omni®**

Same features as M-1019813 but does not include speakers.  
 89 x 38 x 48 cm; 2.9 kg

**M-1018870**



**Life/form® Blood Pressure Arm**

The pediatric blood pressure arm represents a 5-year old and is programmed to demonstrate the five Korotkoff phases. Select systolic and diastolic settings, adjust volume and pulse rate, and easily calibrate when needed. Has palpable radial pulse. The optional Amplifier/Speaker System (M-1019721 for 110V or M-1020046 for 220V) can be used instead of the speaker in the arm to broadcast sounds for a group. Includes sphygmomanometer, cuff, gauge assembly, six AA batteries (included).

**M-1019791**

Item No.	M-1005621	M-1005622	M-1005623	M-1018870	M-1019813
Palpable radial pulse	✓	✓	✓	✓	✓
Five Korotkoff phases	✓	✓	✓	✓	✓
Systolic and diastolic pressures	✓	✓	✓	✓	✓
Auscultation gap	✓	✓	✓	✓	✓
Pulse rate	✓	✓	✓	✓	✓
Use with any stethoscope	✓	✓	✓	✓	✓
Use with any sphygmomanometer	sphygmomanometer included	✓	✓	✓	✓
External speakers with volume control	optional Speaker System (M-1019721 for 110V or M-1020046 for 220V)	included	included	-	included
Control Unit	included	included	included	included	included
Power supply	100V to 240V	115V	220V	100V to 240V	100V to 240V
Carrying bag	included	included	included	included	included

# CLINICAL SKILLS | CHILD



## ➤ CAN BE USED WITH ANY STETHOSCOPE!

### **PAT™ the Pediatric Auscultation Trainer**

The PAT™ trainer engages the technology of the SimScope™ stethoscope to simulate pediatric heart, lung, and bowel sounds utilizing a large sounds library. Using the provided SimScope™ stethoscope, users are able to access a large variety of pathological conditions in order to customize scenarios. By placing the SimScope™ over the anatomically correct locations of PAT™, the programmed sounds will be played through the scope, allowing for students to employ and enhance their diagnostic skills. Utilizes an extensive heart, lung, bowel and bruit sounds library

- Listen at anatomically correct auscultation sites
- Customized library available to fit specific scenarios and programs
- Portable and lightweight
- Easy to use
- WiFi upgrade allows for remote selection of sound scenarios

Delivery includes a male manikin, a DELL Laptop with a pre-installed software, a SimScope™, the SimScope™ software and site license, a USB cable, 1 PAT T-shirt and a user's manual.

**M-1020096**

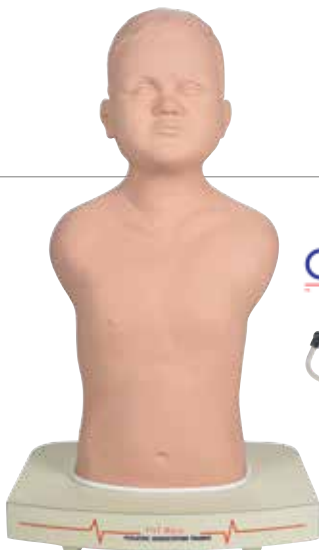
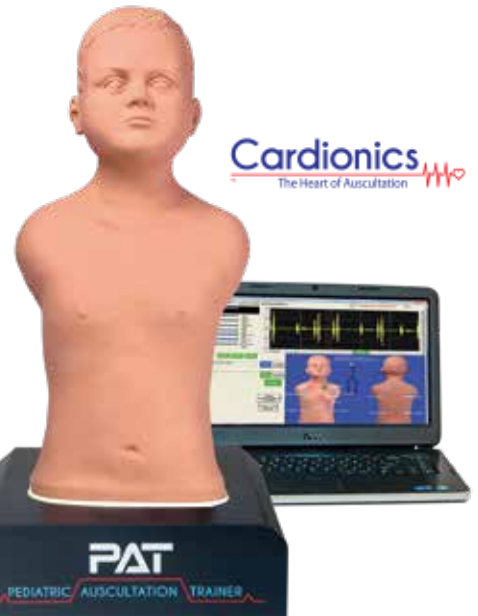

**Cardionics**  
The Heart of Auscultation



### **PAT Basic™ with WiFi**

Heart, lung and bowel sounds can be changed on the laptop and transmitted immediately to PAT Basic™ via WiFi connection.

**M-1020100**

### **PAT Basic™ without WiFi**

Heart, lung and bowel sounds can be changed on the laptop and transmitted to PAT Basic™ via cable (included).

**M-1020098**



PLEASE REFER TO PAGE 151 TO SEE MORE AUSCULTATION TRAINERS

### Child Heart & Lungs Sound Trainer

This self-contained heart and lung sound generator delivers site-specific heart and lung sounds typical of a 4-year old child. Use any stethoscope in the normal auscultation site for pediatric assessment to listen as ten lung speakers and a heart speaker mimic actual sounds. The unit can be run from either a conventional PC using your mouse and monitor, or through the special handheld remote. An external speaker jack allows you to broadcast sounds to the entire classroom, or you can use it for audible testing of more than one student at a time. Classroom broadcasts of speakers/sounds in specific locations allow students to hear precise sound anomalies encountered when they auscultate the manikin. No programming required. Simply plug in, attach your USB mouse and monitor cable, and point and click your way to student excellence in lung and heart sound knowledge.

The simulator comes with a power cord, user reference, and carrying case. No assembly of manikin or installation of programming is required.

48.3 x 45.7 x 23 cm

**M-1017237**



### Life/form® Infant Auscultation Trainer

The Life/form® Infant Auscultation Trainer simulates heart, bowel, and lung conditions selected by the instructor via wireless remote control. The student must palpate to identify the correct auscultation sites and will hear different heart, bowel, and lung sounds as the SmartScope® is moved from site to site. The instructor can program the remote control, selecting from two dozen conditions and even switch conditions so students can compare and make a diagnosis.

Includes Infant Auscultation Trainer, SmartScope® remote, and hard carrying case.

**M-1017975**

### Heart and Lung Sounds Simulator, 5-year old

Students must learn where the base heart sound may be best heard or where the bell should be placed to hear stress or wheezing in a young child. Site specificity is obtained through an exciting new wireless technique in which the student uses anatomic landmarks on the manikin to locate the site where a specific sound should be heard. If correct, they will hear the appropriate sound through the stethoscope and/or external speakers.

**M-1020853**



## ► TRAIN PEDIATRIC CAUDAL INJECTION AND LUMBAR PUNCTURE PROCEDURES



### Life/form® Pediatric Lumbar Puncture Simulator

The Life/form® Pediatric Lumbar Puncture Simulator represents a 10 – 12 month old infant placed in a left lateral decubitus position with the neck and knees flexed, approximating the necessary fetal position. The embedded iliac crest offers exceptional realism, while the removable spine, spinal canal and skin pad make training simple and hassle free.

- Perform lumbar puncture in the L3-L4, L4-L5 or L5-S1 spaces
- Palpate iliac crest and spine to find correct locations
- Fluid flows when needle is inserted correctly

9 kg  
**M-1017244**



### Life/form® Pediatric Caudal Injection Simulator

Caudal block is widely used as a safe, easy, and effective method of regional anesthesia in pediatric surgery. This dual-purpose simulator represents a 12-month-old infant in the left lateral decubitus position with neck and knees flexed. Retaining all the functions of the Pediatric Lumbar Puncture Simulator (M-1017244, presented above), this trainer also includes an anatomically correct coccyx with sacral hiatus for more realistic practice. Features include embedded iliac crest for exceptional realism, removable spine, tactilely correct spinal canal, and two soft skin pads – one transparent for preliminary anatomic study, and one opaque for more advanced hands-on training. Fluid flow provides immediate feedback on proper needle placement for either procedure. Students will appreciate the opportunity to practice these two important procedures on a single simulator that is both appealing and anatomically accurate.

#### Benefits:

- Targets key skills specific to pediatric lumbar puncture and caudal injection procedures
- Palpation of landmarks
- Needle positioning and insertion
- Cerebrospinal fluid collection
- Measure cerebrospinal fluid pressure
- Intrathecal injections
- Practice two procedures with one simulator

**M-1022141**

A photograph of the Nita Newborn™ Infant Venous Access Simulator. It shows a realistic infant mannequin lying on its back on a white base, with various medical supplies including a syringe, a small bottle, and a tube. A red circle with a diagonal line through it and the word "LATEX" is overlaid on the image, indicating that the simulator is latex-free.

**Nita Newborn™ Infant Venous Access Simulator**  
A unique, anatomically correct female baby developed to teach and practice the vascular accessing of newborns and infants. Barely discernable blue Dermalike™ veins are under the replaceable translucent skin on the head, arms and the right leg. Veins give a realistic pop and flashback when needle is properly placed. The veins presented include the temporal, external jugular, post-auricular, basilic, cephalic, saphenous and popliteal. Practice accessing, securing, site care, and maintenance for standard IVs and PICC (Peripherally Inserted Central Catheter). Nasal and oral openings allow placement of nasal cannulas, as well as nasogastric and feeding tubes to teach suctioning, securing, dressing, cleansing, and maintenance.  
**M-1009799**

### Life/form® Infant Male and Female Catheterization Trainer

The Infant Male and Female Catheterization Trainer is an inexpensive 2-in-1 trainer that provides realistic practice of this difficult skills procedure.

- Practice insertion, position, catheter balloon inflation and deflation
- Feel resistance and pressure as with a real patient
- Urine flows when catheter is in proper position
- Practice both male and female infant catheterization training
- Anatomically realistic with both male and female genitals
- Genitals made of soft, life-like material
- Replaceable male and female genitals
- Lower half of infant only
- Design for use with a standard 8 French Slatex or silicone intermittent catheter

Includes: infant manikin, one male and one female genital insert, 60 ml lubricant, infant foley catheter, and instruction manual.

**M-1013060**



#### Consumables and replacement parts:

Lubricant Kit – 3 Pack **M-1009800**

REN Cleaner **M-1005776**

A photograph showing the components of the Life/form® Infant Circumcision Training Kit. It includes a blue carrying case with the Life/form logo, a tan-colored infant manikin torso, several pairs of surgical forceps and scissors, a pair of forceps, and a small white container. A red circle with a diagonal slash and the word "LATEX" is overlaid on the image, indicating that the kit is latex-free.

### Infant Circumcision Training Kit

Made with soft, life-like material. The trainer includes the foreskin, glans penis, frenulum, meatus, and coronal groove. Practice separating foreskin from the glans, removal of the foreskin, and suturing techniques. The trainer has been designed for clamp methods, dorsal slit, and sleeve circumcisions. The trainer may also be used to demonstrate the procedure and practice aftercare skills to family members. Since there are different methods of circumcision, the circumcision trainer has been designed for Mogen clamp method, Guillotine clamp method, Gomco clamp method, plastibell method, dorsal slit method, forceps guided method, and sleeve circumcision. The Infant Circumcision Training Kit is a complete kit for all circumcision training needs.

**M-1017254**

### Life/form® Pediatric Head

An invaluable tool for demonstrating and practicing infusions and injections in the temporal and jugular veins of a newborn to a twelve-month-old infant. Provides realistic sensation and response. The life-like vinyl skin actually rolls as you palpate to allow location of the vein. The synthetic rubber tubing for the veins was carefully selected to provide a life-like simulation of vein size, and feeling of puncture and palpation for practicing venipuncture. The temporal vein of the Life/form® pediatric Head is easily accessible for IV infusions. Practice in the jugular vein is equally realistic. The neck is made of soft, flexible foam to provide a realistic feel of palpation and puncture.

Supplied with realistically modeled head with skin and veins, fluid supply bag, 2 different gauge winged infusion needles, artificial blood and hard carrying case.

**M-1005630**

#### Consumables and replacement parts:

Head Skin and Vein **M-1005631**

Artificial Blood, 1 liter **M-1005611**

REN Cleaner **M-1005776**



## > VALUABLE TOOL FOR PRACTICING INJECTIONS ON PEDIATRIC PATIENTS

### Injection Training Arm, 1-year old

**Simulates the arm of a 1-year old and features:**

- Medial venous structure
- Two veins in dorsum of hand
- Radial and brachial arteries
- Squeeze bulb simulating either collapsed or normal veins
- Easily replaceable skin and veins that withstand multiple needle sticks

Mounted on smoked Lucite® base and supplied with blood bag and stand, synthetic blood concentrate, squeeze bulb, and spare arm skin.

Soft carrying bag and instruction manual included.

**M-1018861**

### Injection Training Arm, 5-year old

The Mike® and Michelle® injection arm with hand simulate that of a 5-year old, with life-like venous structure. The dorsum of the hand has two veins for additional intravenous set-up. Two interchangeable hands are supplied with the simulator.

**Features:**

- Intravenous injections, infusion, and blood collection
- Subcutaneous injections in both flexor and lateral sides of forearm
- Intramuscular injections in deltoid area
- Squeeze bulb simulating either collapsed or distended veins

Mounted on smoked Lucite® base and supplied with blood bag and stand, synthetic blood concentrate, squeeze bulb, and spare arm skin.

Soft carrying bag and instruction manual included.

**M-1018860**

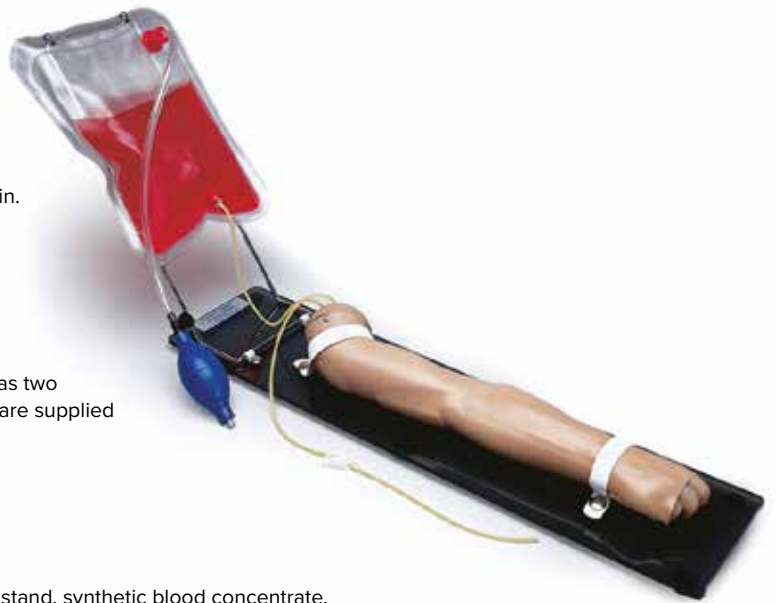

### Life/form® Infant IV Arm

This infant IV arm features an extremely thin, synthetic skin, and rubber tubing with appropriately small lumen and thin walls. The cephalic and basilic vein are accessible, as well as the dorsal venous arch on the hand.

Comes with two IV bags with clamps, 470 ml of blood and winged infusion set. Fluid supply stand not included.

20 x 13 x 13 cm

**M-1017949**



### Life/form® Pediatric Arm

Providing realistic sensation and response, the life-like vinyl skin rolls when palpated to allow location of the vein. A soft foam is used to simulate the deltoid muscle and allows the student to get the feel of administering intramuscular injections to children. Simulated bone in the shoulder defines and limits the injection area. Water may be used as an injection fluid in the shoulder area.

Includes a Life/form® arm with white skin, fluid supply bag, 3 cc syringe, one pint Life/form® blood, teaching guide, and hard carrying case.

56 x 28 x 15 cm

**M-1017973**

**Consumables and replacement parts:**

**Skin & Vein Kit M-1018148**

**Artificial Blood M-1005611**

**REN Cleaner M-1005776**



**Newborn Intraosseous Infusion and Injection Leg**

The Susie® and Simon® Intraosseous leg simulates that of a newborn. A replaceable tibial bone lies under a smooth outer skin. It includes anatomic landmarks for teaching intraosseous access and infusion. A femoral vein/artery pair is included.

- Anatomic features include: iliac crests, lumbar vertebrae L2 – L5, ligamentum flavum, epidural space, and dura
- Life-like needle resistance, including pops when needle traverses ligamentum flavum and dura
- Self-healing skin that allows 15 uses with an 18 gauge needle and 25 uses with a 22 gauge needle
- LED displays pressure set-point ranging from low, medium to high pressure
- Trainer can be used to simulate aseptic technique and local anesthetic at puncture site

**M-1018460**



**Life/form® Infant IV Leg**

This infant IV Leg features an extremely thin, synthetic skin and is paired with rubber tubing featuring a small lumen and thin walls. The greater and lesser saphenous veins are accessible, as well as the dorsal venous arch on the foot. Comes with two IV bags with clamps, 470 ml of blood, one 3 cc syringe, one 22-gauge needle, and winged infusion set. Fluid stand not included.

**M-1017950**



**Life/form® Intraosseous Infusion/Femoral Access Leg**

The Intraosseous Infusion/Femoral Access Leg allows for intraosseous infusion practice and includes palpable landmarks such as the patella, tibia, and tibial tuberosity; replaceable bones and skin; and a pressurized system to allow aspiration of fluid. For femoral access, features include palpable arterial pulse, realistic flashback from pressurized venous system, replaceable injection pad, and an articulated leg that allows proper positioning. 15-gauge intraosseous infusion needle included.

81 x 18 x 20

**M-1019792**

**Life/form® Infant Single Intraosseous Infusion Leg**

This simulator comes complete with 10 replaceable bones, two sets of replacement skins, and a fluid administration kit enabling you to actually visualize a flashback and infuse fluid into the leg. Intraosseous infusion needle included.

30 x 25 x 10 cm

**M-1017951**



ATTACHES TO THE LIFE/FORM® CRISIS™ MANIKINS FROM PAGE 42

# INJECTION TECHNIQUE

## EPIDURAL AND SPINAL INJECTION

### 3B Scientific® Epidural and Spinal Injection Trainer P61

Train the localization of the epidural space without ultrasound to administer epidural and spinal injections. You can easily adjust the trainer to simulate different pathologies. The training with realistic haptic feedback and correct anatomical landmarks is the basis for a successful preparation for real-life cases.



+

### CompuFlo® Epidural Trainer

The CompuFlo® Epidural Trainer's real time measurements combined with the extremely realistic haptic feedback from 3B Scientific's Epidural and Spinal Injection Trainer M-1017891 helps reduce the number of attempts and enhances the training. **M-1022442**

More information on this product is available on page 10





**Sturdy, non-slip construction, easy to set up**



**Continuously adjustable fluid pressure system on the backside**

**Training features:**

- Realistic anatomical landmarks for assessing the correct insertion point
- Loss of resistance (LOR) syringe technique through realistic haptic feedback
- Hanging drop method: the negative pressure in the fluid filled spinal canal can easily be adjusted
- An epidural catheter can be inserted into the epidural space
- Spinal anesthesia training with realistic resistance of the dura and arachnoid mater with or without a cannula

**About the trainer:**

- Developed in Germany in close cooperation with epidural anesthesia specialists
- Simulates the anatomy of a standard patient (young adult between 20-30 years old)
- Intuitive to handle, continuously adjustable fluid pressure
- Easy to clean: filled with water (closed system) to simulate spinal fluid
- Sturdy construction, all parts are integrated and latched
- Can also be used in lateral position, suction cups ensure steady positioning on the table

**Low operating costs:**

With the use of high-quality, hard-wearing materials, only a few parts need to be replaced periodically.

45 x 35 x 24 cm; 3 kg

**M-1017891**

Delivered fully assembled. All usual materials can be used, including disinfectant, plasters and wound dressing. Includes 1 LOR (Loss-of-Resistance) kit and 1 skin pad.

Consumables and replacement parts	Item No.
Replacement LOR Kit Standard Patient	M-1017893
Replacement Skin	M-1017892
Carrying Bag (not included)	M-1018079

**> ADD THIS NEW GERIATRIC INSERT FOR ADDITIONAL TRAINING POSSIBILITIES:**

**> SIMULATES THE TYPICAL SPINE DEFORMATION OF AN ELDERLY PATIENT: OPTIONAL GERIATRIC INSERT TO COMPLETE YOUR EPIDURAL AND SPINAL SKILL TRAINING**

**Geriatric LOR Insert with 1 Spinal Tube for P61**

This quick interchangeable geriatric insert represents the characteristic soft tissue structure (decreased resistance) and the deformed bone structure of an elderly patient for advanced training possibilities.

**M-1020800**

**Geriatric LOR Insert Set of 2 (not shown) P61**

**M-1020629**



**PLEASE VISIT 3BSCIENTIFIC.COM FOR MORE INFORMATION ABOUT OUR INJECTION TRAINER**



# I.V. INJECTION



## 3B Scientific® I.V. Injection Arm P50/1

This injection arm made of 3B Scientific® SKINIlike™ silicone allows realistic, hands-on training to develop competence in medical staff. The material used is of the highest quality, stain resistant and easy-to-clean.

### *The simulator is ideal for practicing:*

- Intravenous injections
- Correct puncture of peripheral veins for blood sampling (basilic vein, cephalic vein, median cubital vein, dorsal venous rete of hand)
- Positioning of a butterfly catheter

Delivered with stand, 250 ml artificial blood concentrate, 2 replacement tubing systems, infusion bottle, syringe and deluxe storage carton.

90 x 40 x 46 cm; 2.5 kg

**M-1021418**

Consumables and replacement parts	Item No.
Spare Tube Systems, 3 items	M-1021427
Spare Skin	M-1021426
Artificial Blood Concentrate	M-1021251
Update Kit Infusion System	M-1021421



## SMASH Advanced Patient Training Arm

The training arm features an extremely durable design and is made of high quality material. The skin can be pierced in excess of 200 times with a 20 or 22 gauge needle. A micropump has been embedded within the shoulder to generate variable heart rates and pulse strengths for a realistic training experience.

### *The following training possibilities are featured:*

- Subcutaneous injection on volar forearm and lateral upper arm
- Intramuscular injection on upper arm
- Suture and incision on both upper arm and forearm
- Haemodialysis on the forearm
- I.V. and blood draw exercises, AV anastomosis, and placement of AV grafts
- Incision and suturing exercise on multi-layered inserts (skin, subcutaneous tissue, muscle, radial artery, and radial vein)
- Surgical and arterial & venous stick exercises
- Collapsed or bulging vessels simulated by varying vessel palpability

**M-1019645**



## Geriatric I.V. Arm

Developed from a live cast, this arm is unique to the industry. Its properties include veins that roll away or disappear as you attempt to catheterize the vessel and the specially developed skin is exceptionally thin. If your students work with the aged, this adjunct to your teaching lab will enable them to better serve this group as they pursue their careers.

91 x 36 x 23 cm; 7 kg

**M-1005777**





### Advanced Multipurpose Venous Training Arm

*This right arm combines all features required for I.V., I.M. and subcutaneous injection and infusion training as well as blood collection exercises:*

- I.V. injection in subtle venous network of the arm and hand: cephalic, basilic, antecubital, radial and ulnar veins. A pressure bulb increase or decrease enables venous pressure
- I.M. injection in deltoid area
- Subcutaneous injection on the volar side of the forearm and the lateral side of the arm

Supplied with artificial blood, blood dispensing bag, funnel, talcum powder, replacement skin and veins, base and carrying bag.  
76 x 15 x 15 cm

**M-1005809**

### Intravenous I.V. Training Arm

This training arm features a prominent venous network with simulated cephalic, basilic, antecubital, radial, and ulnar veins.

**The following can be trained:**

- Simulation of infusion technique
- Blood collection exercises with simulated blood
- Administration of medication by intravenous bolus
- Simulation of clenched fist or tourniquet position
- Simulation of collapsed veins
- A realistic pop appears as the needle enters the vein. Manufactured with resealing veins and outer skin for repeated usage

Delivery content includes soft carrying bag and set-up kit (simulated blood concentrate, pressure bulb, blood dispensing bag, spare arm skin, funnel, and talcum powder).

76 x 15 x 15 cm

**M-1018755**

### Life/form® Portable I.V. Hand and Arm Trainer

The economic Life/form® Portable I.V. Trainer combines realism and lightweight convenience in a single device. Constructed of soft material with life-like veins that are visible and palpable. Venipuncture can be practiced at any of the common sites (antecubital fossa, along the forearm, the back of the hand, and thumb) with the following features:

- Realistically rolls as you palpate the veins
- Characteristic pop can be felt as the needle penetrates the vein
- Realistic flashback can be observed

Ideal for teaching venipuncture techniques including starting IVs and introducing over the needle IV catheters. Under normal use, hundreds of injections may be performed. The storage box can be converted into a workstation.

Includes: 2 IV bags, packet of blood powder, fluid supply stand, 2 pinch clamps, 3 cc syringe, 12 cc syringe, 12 gauge needle, a winged infusion set, and a plastic clamshell case for storage.



#### I.V. Hand

Light Skin **M-1017958**

Dark Skin **M-1017959**

#### I.V. Arm

Light Skin **M-1017960**

Dark Skin **M-1017961**

#### I.V. Arm and Hand Trainer

Light Skin **M-1013746**

### I.V. Training Hand

An economic and easy to transport model to train I.V. injection. Made of durable material for repeated use.

#### Features:

- Palpable life-like veins that roll-over
- Suitable for blood sampling or fluid injection
- Supplied with carrying tray and artificial blood

35 x 13 x 5 cm; 0.8 kg

**M-1005754**



### Life/form® Venatech IV Trainer

This I.V. trainer is easily attached to a person's arm so the student can practice venipuncture techniques without the risks associated with puncturing living tissue. Includes the three main veins used in phlebotomy in correct anatomical position. The trainer also helps students learn basic communication skills such as explaining the procedure to the patient and asking them to close and release their fist.

**M-1017966**



### Injection Training Hand

The back of the hand is the most common site for injection training. With this model you can teach the common procedure for IV drips. Comes with blood powder.

**M-1017962**



▶ PLEASE TAKE A LOOK AT THE TABLE BELOW TO FIND AN I.V. TRAINER THAT BEST FITS YOUR REQUIREMENTS

	Venatech I.V. Trainer	Injection Training Hand	Portable I.V. Hand Trainer	Portable I.V. Arm Trainer	I.V. Training Hand
Item no.	M-1017966	M-1017962	M-1017958	M-1017960	M-1005754
Simulated blood	included	-	included	included	included
Vein stand	-	-	included	included	-
Vein palpation and realistic "pop" as needle enters	-	-	included	included	✓
Phlebotomy	included	-	-	-	-
IM site	-	-	-	-	-
Subcutaneous injection	-	-	-	-	-
Intravenous bolus injection	-	-	-	-	-
Sterile technique	-	-	-	-	-
Infusion technique	-	-	-	-	-
Suture, incision and hemodialysis site	-	-	-	-	-
Arterial, venous and AV fistula insert	-	-	-	-	-
Pressure squeeze bulb and clenched fist simulation	-	-	-	-	-
Simulation of collapsed veins	-	-	-	-	-
Care of the catheterized site	✓	✓	✓	✓	-
Replacement skin and veins	Skin M-1021707	on request	on request	on request	on request
Carrying system	-	-	plastic case	plastic case	-

### I.V. Injection Hand

An incredibly realistic hand with extreme attention to detail, right down to the fingerprints. Students have the opportunity to not only practice injection but to develop important manipulation skills provided by the flexion of the wrist. Under normal use hundreds of injections can be performed before skin or veins need replacement.

- Includes injectable metacarpal, digital and thumb veins on dorsal surface
- Soft, flexible fingers are separately molded
- Flexible wrist
- Skin rolls when veins are palpated
- Perform hundreds of injections before replacing vein and skins
- Supplied in storage box

**Light Skin M-1017963**

**Dark Skin M-1017964**



Consumables and replacement parts	Item No.
Veins	M-1005665
Replacement Skin and Veins	M-1005667
Venous Blood (1 liter)	M-1005611
Fluid Supply Bag	M-1005693
Fluid Supply Stand	M-1005692
REN Cleaner	M-1005776

I.V. Injection Hand	I.V. Arm & Hand Trainer	3B Scientific® I.V. Injection Arm	Intravenous Training Arm	Injection Arm	Geriatric I.V. Arm	SMASH Advanced Patient Training Arm
M-1017963	M-1013746	M-1021418	M-1018755	M-1005809	M-1005777	M-1019645
included	included	included	included	included	included	included
-	included	included	included	included	-	✓
included	included	✓	✓	✓	✓	✓
-	-	-	-	-	✓	✓
-	-	-	-	in deltoid area	-	✓
-	-	-	-	✓	-	✓
-	-	✓	✓	✓	-	✓
-	-	✓	-	-	✓	-
-	-	✓	✓	✓	✓	✓
-	-	-	-	-	-	✓
-	-	-	-	-	-	✓
-	-	-	✓	✓	-	-
-	-	-	✓	-	-	✓
✓	✓	-	✓	✓	✓	✓
Skin M-1005667 Veins M-1005665	on request	Skin M- 1021426 Veins M-1021427	on request	Skin M-1013384 Veins M-1013385	Skin M-1020949 Veins M-1021257	Skin M-1012333 Veins M-1020609
storage box	plastic case	storage box	included	included	-	included

# I.M. INJECTION

## > THE PERFECT VOLUNTEERS TO PRACTICE I.M. INJECTIONS

### 3B Scientific® I.M. Injection Simulators

These high quality simulators are the ideal way to teach proper I.M. injection techniques. Strap it onto the upper leg, upper right arm or the buttocks to locate all necessary intramuscular injection sites. Operates on AA batteries.

- Both audio and visual feedback
- Use for training and performance evaluation
- Includes all important anatomical palpable landmarks
- Life-like silicone skin is extremely durable, can quickly be exchanged
- Robust and easy to clean



Upper Arm  
M-1009840



Buttock  
M-1000514

## > INTRAMUSCULAR INJECTION CAN BE PRACTICED REALISTICALLY WITHOUT A REAL PATIENT – WITH BOTH AUDIO AND VISUAL FEEDBACK!



Upper Leg  
M-1000511



## ➤ PRACTICE ECONOMICALLY INTRAMUSCULAR INJECTION TECHNIQUE!

### 3B Scientific® I.M. Injection Simulator

Enables students to practice carrying out intramuscular injections cost-effectively and to repeat the procedure over and over. This practical and compact I.M. trainer is the perfect solution for clinical injection training in large class settings. delivered with three skin pads that can be pierced multiple times.

- Practice intramuscular injection with fluid up to a depth of 50 mm
- Quick-change skin pads that can be pierced multiple times
- Easy to clean and dry

**M-1010008**



### Life/form® Intradermal Injection Simulator

Practice intradermal injections safely and conveniently!

- Life/form® vinyl skin ensures a realistic training experience
- Features eight sites for practicing intracutaneous injections
- Natural cast from wrist to just below elbow
- Skin has realistic feel and appearance

Includes arm section with eight injection sites, sealant, syringe, teaching guide, and storage box.

33 x 28 x 13 cm; 0.9 kg

**M-1005628**

Consumables and replacement parts	Item No.
Liquid Skin Repair	M-1013686
REN Cleaner	M-1005776

### Life/form® I.M. Injection Simulator

The simulator offers both visual and tactile learning for three types of intramuscular injections.

- Identification of proper injection sites and visualization of underlying structures
- Practice of dorsogluteal, ventrogluteal, and vastus lateralis injections

Comes complete with teaching guide, supply of syringes, and hard carrying case.

56 x 24 x 40.5 cm; 8.5 kg

**M-1005586**

Consumables and replacement parts	Item No.
Replacement Muscle	M-1019801
REN Cleaner	M-1005776





### Two-in-One I.M. Injection Model of Buttock

***This unique model of a human buttock has a special two-in-one function with audio-visual feedback:***

1. Study the anatomy on the right hand side (bones, ilium crista, greater trochanter, m. gluteus medius, nerves and veins) through the transparent outer structure.
2. Transfer this knowledge about the position of nerves, veins etc. to the left hand side to find the correct insertion point and practice I.M. injections with fluid (water).

Correct injections are confirmed by a green light, incorrect by a red light and a buzzer.

38 x 35 x 22 cm; 5 kg

**M-1005394**



**Indicator light illuminates when Shibusanbu method has been performed correctly**



**Special skin material does not show needle marks**

➤ PLEASE TAKE A LOOK AT THE TABLE BELOW TO FIND AN INJECTION TRAINER THAT BEST FITS YOUR REQUIREMENTS

	Intramuscular Injection Simulator - Upper Arm	Intramuscular Injection Simulator - Upper Leg	Buttock Injection Simulator	Intramuscular injection simulator	Intramuscular Injection Model of Buttocks	Intramuscular Injection Simulator	Intradermal Injection Simulator
<b>Item No.</b>	<b>M-1009840</b>	<b>M-1000511</b>	<b>M-1000514</b>	<b>M-1010008</b>	<b>M-1005394</b>	<b>M-1005586</b>	<b>M-1005628</b>
<b>Body part</b>	upper arm	upper leg	buttock	muscle extract with skin	pelvis with buttocks	lower torso	forearm
<b>Palpable anatomical landmarks</b>	✓	✓	✓	-	✓	✓	-
<b>Injection type</b>	intramuscular	intramuscular	intramuscular	intramuscular	intramuscular	intramuscular	intradermal
<b>Injection sites</b>	as indicated by a trainer	as indicated by a trainer	as indicated by a trainer	all the surface	as indicated by a trainer	as indicated by a trainer	eight
<b>Proper injection</b>	audiovisual feedback	audiovisual feedback	audiovisual feedback	-	green light will appear	-	skin welt will form
<b>Additional information</b>	training and test modes are available	training and test modes are available	training and test modes are available	will absorb fluid	special skin material does not show needle marks	simulated bony structure is embedded in the torso	liquid skin repair kit included (M-1013686)

# VENIPUNCTURE



## Advanced Venipuncture and Injection Arm

This revolutionary training arm provides complete venous access for IV therapy and phlebotomy, plus sites for intramuscular and intradermal injections. An extensive 8-line vascular system allows students to practice venipuncture at all primary and secondary locations, including starting IVs and introducing over the needle IV catheters.

- Realistic skin texture with wrinkles, pores, and visible fingerprints
- Soft and pliable for easy sewing, sutures will not pull out when tightened
- Supplied with three wounds that can be sutured repeatedly. Conservatively, hundreds of injections may be performed and over one hundred cuts can be made on the trainer before replacement is needed. Delivered with artificial blood, 3cc syringe, 12 cc syringe, needle, two fluid bags, instruction manual and carrying case.

**Light Skin** M-1005678

**Dark Skin** M-1005679

## Two-Vein & Four-Vein Venipuncture Training Aids™

Your patients don't have one size of veins and these models were specifically designed to make accessing more challenging, as this is how technique and confidence are improved. Now made with latex-free Dermalike™ with 50% less needle drag when accessing the underlying veins and improved tear resistance to permit a greater number of needle sticks.

### Two-Vein Option

Two barely discernable blue veins of different inside diameters, positioned at the same depth in a semi-transparent, soft tissue-like material.

**Light Skin** M-1017969

**Dark Skin** M-1017970

### Four-Vein Option

Four barely discernable blue veins in three different sizes – with a fourth vein more deeply placed.

**Light Skin** M-1017971

**Dark Skin** M-1017972



## Arterial Puncture Arm

This easy to use training aid is ideal for training and demonstration of proper arterial blood drawing techniques and for monitoring blood gases.

- Puncture locations can be identified
- Life-like backflow of blood

Delivered with 2 syringes and tubules, artificial arterial blood, 2 replacement arterial sections and carrying case.

71 x 13 x 33 cm

**M-1005598**

## Advanced Four-Vein Venipuncture Training Aid™

In addition to the pop that is felt with the regular models as the needle enters the vein, the advanced version offers a realistic flashback of simulated blood, confirming the proper needle placement. The model permits the injection of fluids and withdrawal of simulated blood. Featuring four barely discernable blue veins in 3 different sizes – with the fourth vein deeply placed in a semi-transparent, tissue-like material.

**Light Skin** M-1017967

**Dark Skin** M-1017968



# IMAGE GUIDED INJECTION



➤ IMPROVE OUTCOMES OF SPINE INTERVENTIONS WITH STANDARDIZED IMAGE GUIDED INJECTION TRAINING!

## 3B Scientific® Image Guided Injection Trainers

*Developed in cooperation with Dr. Markus Schneider, Bamberg*

The Image Guided Spinal Injection Trainers enable trainees and course participants to develop a three-dimensional understanding of the procedures for successful spine interventions. They will learn to correlate imaging with the spinal anatomy relevant to interventional pain procedures, to identify the target tissue and vulnerable structures using imaging and anatomic inspection, and to apply best practices to ensure patient safety during the interventional spine procedures.

- Life-like radiopacity for realistic x-Ray images
- Realistic injection haptics with self-healing material
- Anatomically accurate bone structure
- Visually identifiable landmarks

**The trainers are especially suitable for use in imaging courses thanks to these technical features:**

- Self-Sealing material can be used repeatedly for injection training
- Completely portable with a secure transport box
- Durable construction, easy to clean

**Delivered with:**

- 1 Image Guided Spinal Injection Trainer
- 1 secure transport box
- 1 protective cover
- 1 bottle of 20 ml lubricant
- 1 container of talcum powder

## 3 IDEAL SOLUTIONS FOR THE REPLACEMENT OF CADAVERS IN IMAGING-COURSES & BIOSKILLS-LABS

Lumbar Spine P65



Thoracic Spine P66



Cervical Spine P67

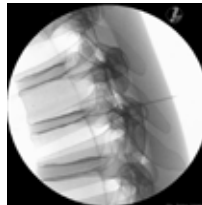
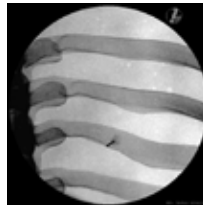
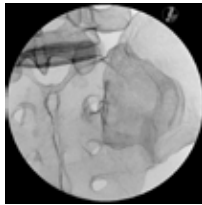
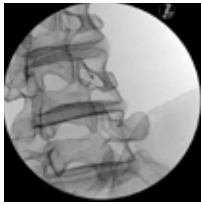
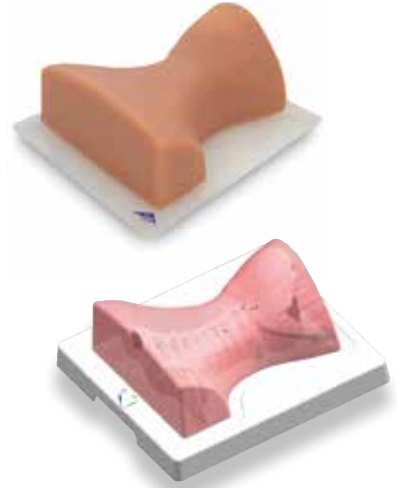

Image Guided Injection Trainer for	Lumbar Spine	Thoracic Spine	Cervical Spine
Item no.	M-1021898 / P65	M-1021899 / P66	M-1021900 / P67
Skeletal Anatomy for imaging and palpation	<ul style="list-style-type: none"> <li>• Sacrum, S1 – S3 (with sacral hiatus canal)</li> <li>• Ilium, bilateral without ischial bone and hip joint</li> <li>• Vertebrae T12 – L5</li> <li>• Coccyx</li> </ul>	<ul style="list-style-type: none"> <li>• Vertebrae T3 – T8</li> <li>• Ribs 3 – 8</li> </ul>	<ul style="list-style-type: none"> <li>• Occipital bone (cranial to external occipital protuberance)</li> <li>• Vertebrae C1 – T2</li> <li>• Ribs 1 and 2</li> </ul>
Interventional spine procedures	<ul style="list-style-type: none"> <li>• Transforaminal Epidural Steroid Injections (TFESI)</li> <li>• Intralaminar Epidural Injection</li> <li>• Facet Blocks</li> <li>• Medial Branch Block (MBB/RF)</li> <li>• S1-block</li> <li>• Sacroiliac Joint Injection (SIJ-injection)</li> <li>• Intradiscal access</li> </ul>	<ul style="list-style-type: none"> <li>• Interlaminar Epidural Steroid Injection</li> <li>• Thoracic Transforaminal Injection</li> <li>• Thoracic Zygapophysial Joint</li> <li>• Intraarticular Injection</li> <li>• Thoracic Zygapophysial Joint</li> <li>• Nerve (Medial Branch) Injection</li> <li>• Intercostal Nerve Block (ICNB)</li> </ul>	<ul style="list-style-type: none"> <li>• Greater Occipital Nerve (GON) Infiltration</li> <li>• Transforaminal Epidural Steroid Injections (TFESI)</li> <li>• Intralaminar Epidural Injection</li> </ul>

References: Instrumentarium Imaging ZIEHM VISTA • Max KVP: 110KV, Total filtration 4.0 mm AL • Focal spot: 0.5/1.5



### Economic alternative to cadavers in imaging courses and bio-skills labs

Self-sealing material enables repeated use of the trainers throughout several courses. Please watch a video demonstration of the material online at [3bscientific.com](http://3bscientific.com).

▶ Scan the code to see the self sealing material

# ULTRASOUND



## 3B Scientific® SONOtrain™ Ultrasound Trainers

- + Easy to use
- + Cost effective
- + Realistic echogenicity
- + Self-sealing for repeated use

## › ECONOMIC ULTRASOUND TRAINING SET FOR MEDICAL SKILLS LABS

### 3B Scientific® SONOtrain™ Ultrasound Trainer

The material of the SONOtrain™ trainer simulates the feel of real soft tissue for carrying out palpations and injections and shows realistic texture and echogenicity on ultrasound images. The SONOtrain™ trainer is an excellent teaching tool for basic training and for improving dexterity and hand-eye coordination skills.

- Each individual unit is completely self-contained and can be used out of the box
- Units are stackable to save space
- Replacement blocks and all accessories are available separately
- The 3B Scientific® SONOtrain™ series has been designed and developed in Germany



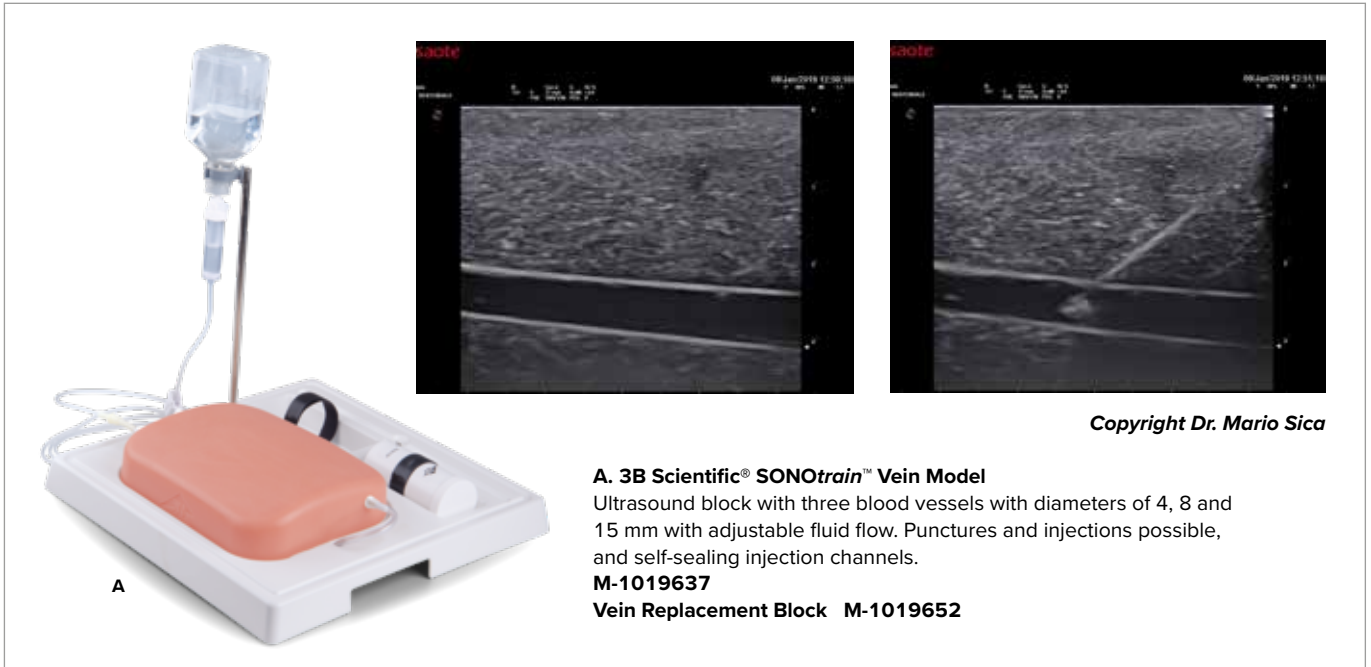

Copyright Dr. Mario Sica

A

**A. 3B Scientific® SONOtrain™ Vein Model**

Ultrasound block with three blood vessels with diameters of 4, 8 and 15 mm with adjustable fluid flow. Punctures and injections possible, and self-sealing injection channels.

**M-1019637**

**Vein Replacement Block M-1019652**

**B. 3B Scientific® SONOtrain™ Foreign Body Model**

Ultrasound block with 6 different foreign bodies: Pellets, shard of glass, nail, projectile, loose chippings and splinters of wood can be clearly detected and recognized.

**M-1019636**

**Foreign Body Replacement Block M-1019651**

**C. 3B Scientific® SONOtrain™ Gallbladder Model**

This Ultrasound block with three gallbladders, each with different pathologies: Gallstones (diameter: 8 and 10 mm), thickened gallbladder wall and biliary sludge deposit. The gallstones and the biliary sludge deposit move as the positioning of the block is changed like it would in a real patient.

**M-1019638**

**Gallbladder Replacement Block M-1019653**

**D. 3B Scientific® SONOtrain™ Breast Model with Cysts**

Realistic reproduction of a breast made from ultrasound material with two cysts for realistic punctures and aspirations.

**M-1019634**

**Breast with Cysts Replacement Block M-1019649**

**E. 3B Scientific® SONOtrain™ Breast Model with Tumours**

Realistic reproduction of a breast made from ultrasound material with three tumours for realistic punctures and biopsies.

**M-1019635**

**Breast Tumours Replacement Block M-1019650**

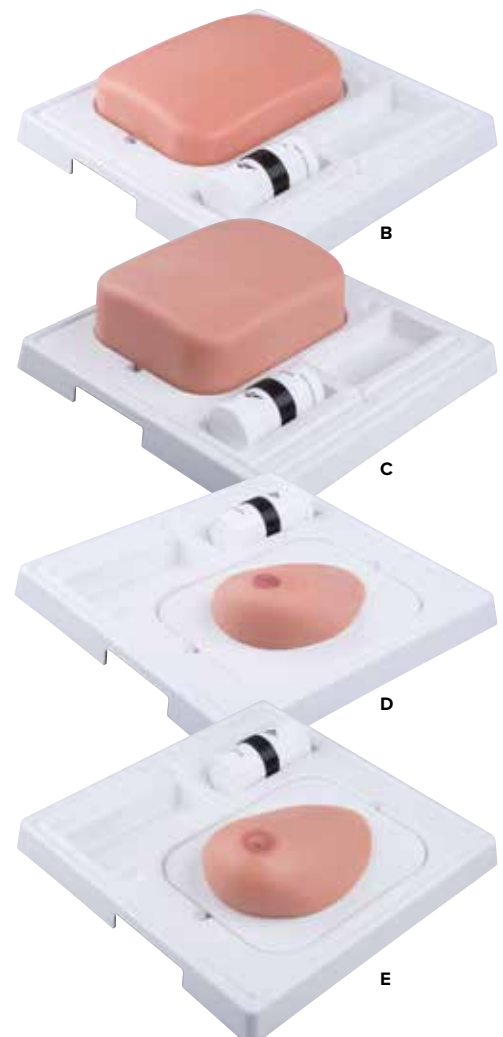

# LAPAROSCOPY

>Lap-X VR, ideal for mandatory laparoscopic skills training

+

- + Automatic software assessment
- + E-learning content with exam questions
- + Exercise videos with comments
- + Online or local log-in for the instructor

## LAP-X VR

LAP-X VR is an innovative virtual reality simulator for cost-effective motor skills training for different surgical specialties. It provides a validated package of various curricula of increasing difficulty to attain proficiency skill levels in all surgical specialties, including gynecology, urology, pediatric surgery, general surgery and gastrointestinal surgery.

LAP-X VR offers an excellent training aid to standardize, structure, and complement hands-on skills training in surgical residency programs. With the possibility of metrics measurement and performance recording as well as online remote assessment, LAP-X VR provides an ideal training solution to help surgical educators save time, effort and money while achieving the best training results.

### Simulator benefits:

- Affordable and easy to set up Virtual Reality system
- Instant feedback with measurements
- Possibility to use real instruments
- Ability to add and modify existing modules and exercises
- Administration tool to monitor the training progress of trainees

**M-1022165**



### Module examples:



**Appendectomy**



**Vessel Cauterization**



**Kidney Complication**



**Complete Nephrectomy**



**Anatomy Preview and Navigation**



**Cholecystectomy**



## ➤ LAP-X HYBRID COMBINES THE FUNCTIONALITY OF A VIRTUAL REALITY TRAINER AND A BOX TRAINER!

### Lap-X Hybrid

Lap-X Hybrid is a laparoscopic simulator that combines the functionality of a virtual reality trainer and a box trainer, providing an innovative and powerful tool for all minimally invasive surgeries.

Users can practise with virtual reality mode at different curriculum modules: basic, novice, intermediate and advance, as well as train with procedural modules such as appendectomy, cholecystectomy, nephrectomy and many others.

The trainee can switch from virtual reality to box trainer mode anytime. As a box trainer, the Lap-X Hybrid has the possibility of metrics measurement and performance recording. All validated box exercises are compatible with the Lap-X Hybrid, providing the user with haptic feedback training. The instructor has the ability to pre-record the example exercises. Trainees can also record their own performance and submit it to the instructor for online assessment.

### Training benefits:

- Using more than 40 different exercises divided into 6 modules with increasing difficulty
- Monitoring trainees' progress via online assessment
- Hybrid function: combining virtual reality and box training for better results
- Receiving instant feedback with values such as duration, path lengths or performance report

### Simulator benefits:

- Ability to use simulator as a box trainer and as a virtual reality trainer
- Exercises with increasing difficulty within the modules
- Instant feedback and scoring evaluation of different parameters
- Possibility to submit video recordings and scores to instructors via internet
- Possibility to review, approve and comment on trainee's video recording via provided website
- Possible to use animal organs

**M-1020117**

### Hard Carrying Case for Lap-X

**M-1020117**



### Lap-X Box

Lap-X Box is the basic version (a traditional box trainer) within the Lap-X simulator series and comes with the hardware needed to perform the following training:

- Moving objects bimanually from one instrument to the other
- Performing tasks under different camera angles via different endoscope insertion points
- Navigating with a 0°, 30° or 60° scope
- Mastering the fulcrum effect
- Completing tasks with one hand while keeping the instrument in the other hand steady

The hardware comes complete with the recording software package necessary to train various training skills. Includes an administration tool to monitor training progress instructors can create different exercises and the students performance can be video recorded and evaluated with the following parameters: time, left path length, right path length.

**M-1020116**

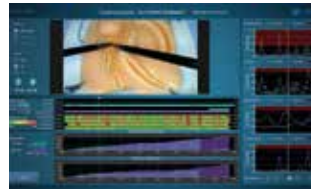

**Timeline analysis**



**Left and right hand summary**

## Laparo Analytic

### Laparoscopic Surgical Skill Trainer with Full Training Analysis

Laparo Analytic is one-of-a-kind laparoscopic trainer with an automated training analysis and progress report for the fundamental skills and techniques of laparoscopic surgery. Every student's training is saved as a video for further evaluation and the performance results are used to create individual learning curve reports.

#### **High-precision sensors analyze the following parameters for both left and right hand:**

Visibility of instruments, Quality of instrument insertion, Path length, Speed, Acceleration, Trembling of hand, Number of grip clamping, Speed of grip clamping Training time and Training symmetry.

#### **The laparoscopic surgery skills simulator was developed for multi-user trainings in Medical Simulation Centers and offers the following technical features:**

- Multi-user network for training in groups
- Skill and development analysis with learning curve report
- 8 trocar positions allow appropriate instrument insertion
- Unlimited trainee accounts and one instructor login
- Intuitive user interface with touch screen
- 30° Full HD adjustable camera with LED light
- Electric height adjustment
- High quality material weakens external light and imitates realistic surgery conditions
- Easy placement of training modules with magnetic connections

#### **The instructor account gives additional benefits:**

- Administrator access to all user accounts
- Master view within the multi-user network for closer control over trainees' progress
- Option to create individual training scenarios with independent analysis parameters
- Possibility to hold a live transmission from the camera, for example from the instructor's device to trainees' devices
- Monitoring of up to 20 student stations (screens) at the same time

**M-1021836**



Scan the code to find out more about Laparo Analytic, a one-of-a-kind laparoscopic trainer which is perfect for a group training!



**Built-in camera and LED light**



**10 insert positions**

## Laparo Advance

**All three versions of Laparo Advance have the following features:**

- Easy and quick installation
- Mobile and stable construction
- 10 precisely designed trocars positions
- 6 training modules included
- Software allows video recording, time tracking and image adjustment
- Adjustable camera with position blocking functionality

### Laparo Advance Training Station

Independent training station with integrated touch-screen and foldable stand with height and worktop adjustment. Wheels with brakes allow to move the trainer fully, worktop has cut-outs to hold instruments.

Comes with a fully integrated touch-screen computer, box trainer, set of 6 modules and 4 laparoscopic instruments.

**M-1021835**



**Laparo Advance Training Station M-1021835**

### Laparo Advance Simple Set

Laparoscopic trainer with built-in camera and LED light, which can be connected to any computer. Comes with a box trainer, set of 6 modules and 4 laparoscopic instruments.

**M-1021834**



### Laparo Advance Modules

Laparoscopic trainer with built-in camera and LED light, which can be connected to any computer. Comes with a box trainer and a set of 6 modules.

**M-1021833**



▶ Scan the code to see the advantages of the Laparo Advance series!

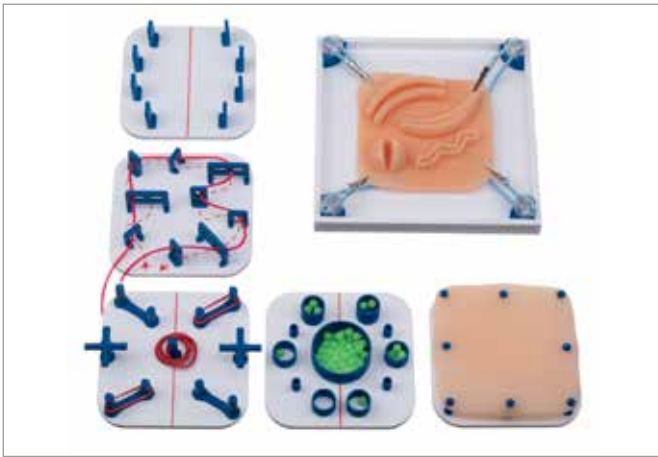

Set of 6 training modules



Set of 4 laparoscopic instruments

➤ PLEASE TAKE A LOOK AT THE TABLE BELOW TO FIND THE LAPAROSCOPIC TRAINER THAT BEST FITS YOUR REQUIREMENTS

	Laparo Advance Modules	Laparo Advance Simple Set	Laparo Advance Training Station	Laparo Analytic
Item No.	M-1021833	M-1021834	M-1021835	M-1021836
<b>Hardware</b>				
Computer with large touch screen	no, but can be connected to any	no, but can be connected to any	✓	✓
Built-in full HD camera and LED light	✓	✓	✓	✓
Number of trocars	-	-	-	2
Trocars positions	8x5 mm / 2x10 mm	8x5 mm / 2x10 mm	8x5 mm / 2x10 mm	8x5/10 mm
Station with height adjustment	-	-	manual	electric
Stable wheels for easy transport	-	-	✓	✓
Included training modules	Suturing, Cutting and Suturing, Universal Holder, Rubber Bands, Threading, Balls	Suturing, Cutting and Suturing, Universal Holder, Rubber bands, Threading, Balls	Suturing, Cutting and Suturing, Universal Holder, Rubber bands, Threading, Balls	Suturing, Cutting and Suturing, Universal Holder, Rubber Bands, Threading, Balls, Needle/Twine Threading
Included Instruments	-	Grasper, Dissector, Scissors, Needle Holder	Grasper, Dissector, Scissors, Needle Holder	Grasper, Dissector, Scissors, Needle Holder
<b>Software</b>				
Software with license code available in multiple languages	✓	✓	✓	✓
Automated training analysis and progress report	-	-	-	✓
Multi-user training with up to 20 connected stations	-	-	-	✓
Video streaming and analysis	-	-	-	✓
Creating own scenarios and adding comments	-	-	-	✓
Trainee and instructor login	-	-	-	✓
Individual learning curve reports	-	-	-	✓
Results exportable to Excel	-	-	-	✓

## ➤ RELIABLE TECHNOLOGY HOUSED IN A DURABLE CONSTRUCTION!

### T5 Pelvic Box Series for Laparoscopic Skill Training

The large pelvic box is the most versatile system that is used from basic skill development to advanced procedure training. It is torso-like in size with 14 ports that are fitted with grommets designed to hold an instrument or trocar. The T5 Series is a complete portable system that does not require video tower equipment and is easy to set up.

#### **Skill training:**

- Laparoscopic suturing
- Basic and advanced laparoscopic procedures
- FLS® Skills practise
- Laparoscopic camera navigation (LCN)
- Hands-on skills training
- Psychomotor skills
- Hand-eye coordination and depth perception

Includes large pelvic box with 14 laparoscopic ports with fitted interchangeable 5 and 10 mm grommets and interior lighting. The SimScope™ simulates a real laparoscope and can be inserted into any of the 14 laparoscopic ports. It zooms and rotates, has a realistic handle and is available in 0° and 30°.

#### **Available in two configurations:**

##### **T5 Large Pelvic Box with Removable Monitor**

Designed to remove the monitor from the trainer and attach it to the included stand, giving the user the ability to rotate and drape the box for a more realistic training experience.

**M-1020092**

##### **T5 Large Pelvic Box with Attached Flip-up Monitor**

**M-1020091**



VISIT [3BSCIENTIFIC.COM](http://3BSCIENTIFIC.COM) TO SEE A FULL LIST OF AVAILABLE OPTIONS TO ENRICH YOUR LAPAROSCOPIC TRAINING!

### T3 PLUS: Portable Laparoscopic Skill Training Box

The NEW T3 PLUS is a complete minimally invasive training system that does not require video equipment, is portable and easy to set up. It has a joystick camera that zooms and rotates. The expanded front provides room for a wider selection of skill inserts. The T3 PLUS includes the redesigned pelvic box, SimScope™ (camera) and 10" monitor. The T3 PLUS provides a versatile one-person laparoscopic skill training workstation.

**M-1020150**



## > The Bionic Hybrid Simulator

When worn by the standardized patient, the suit simulates physiological conditions to test diagnostic and procedural skills. It is controlled wirelessly with easy to use software and responds in real time to diagnosis and treatment with direct feedback. Features 5-wire EKG connections, pulse points, optional blood pressure cuff accessory, as well as auscultation capabilities. Instructors can easily adjust and adapt the suit scenarios to fit many conditions wirelessly by using the SimScope™ Wifi. SimScope™ Wifi and tablet included with system. Reusable and washable (30°C), available in different sizes.

**M-1021981**



- + Controlled wirelessly
- + Capable of recreating many simulated medical situations to supplement almost any curriculum
- + Enhances the exam performance by responding in real time to diagnosis and treatment
- + Can be worn by a manikin

### The SimShirt System

The Shirt offers a basic version with all features of the suit, except EKG, carotid pulse and possibility to use with a blood pressure cuff. Includes SimScope™ Wifi and tablet. Reusable and washable (30°C), available in different sizes.

**M-1021552**



	SimShirt System	Bionic Hybrid Simulator
<b>Item No.</b>	<b>M-1021552</b>	<b>M-1021981</b>
<b>Can be worn by students and manikins</b>	✓	✓
<b>Simulation of heart, breath, and bowel sounds</b>	✓	✓
<b>RFID sensor tags integrated</b>	✓	✓
<b>Simulates multiple physiological conditions</b>	✓	✓
<b>Real time diagnostics and treatment capabilities</b>	✓	✓
<b>Radial pulse</b>	-	✓
<b>Carotid pulse</b>	-	✓
<b>5-wire EKG connection</b>	-	✓
<b>Can be used with Cardionics' blood pressure accessory</b>	-	✓
<b>SimScope™ Wifi</b>	included	included
<b>Tablet with pre-installed software</b>	included	included

➤ **FREE ACCESS TO SAM ONLINE FOR ONE YEAR WITH EACH SAM 3G® PURCHASE!**

**New SAM 3G® Student Auscultation Manikin**

With the new Cardionics SAM 3G® Student Auscultation Manikin 3rd Generation, teaching and learning auscultation becomes even more versatile and economic. SAM 3G® Trainer can be used with any stethoscope available and offers the largest Real Sound Library, Case Videos, Echo Cardiogram Videos and ECG Waveforms for students to master identification of various heart, lung and bowel sounds. All sounds and videos are recorded from live patients for students to experience a life-like simulation. Case videos contain patient and clinical interactions for various conditions and enhance the learning by providing visual representation of the sounds. Users can also create and save their own case videos.

Delivered with a portable SAM 3G® male auscultation torso, a DELL laptop with pre-installed software, a digital copy of SAM's Lesson Guide, a stethoscope and user's manual.

**M-1021554**

**Speaker System available additionally, M-1021753**



- + Largest library of sounds and videos
- + Can be used with any stethoscope
- + Palpable carotid pulse
- + Lightweight and portable



**SAM II, the Student Auscultation Manikin**

This Student Auscultation Manikin is a new innovation in teaching and learning heart, breath & bowel sounds. While SAM II is used in many simulation centers, it is also easily moved into a classroom or auditorium for group instruction. The computer software interface is easily projected into any smart classroom. The software includes phonocardiograms, correct anatomical locations, and written lessons for each sound.

Delivery includes a male manikin, a DELL laptop computer with SAM II software installed, a digital copy of SAM II's Lesson Guide, and an user's manual. The lesson guide is currently available in English.

**M-1020095**

**SAM Basic™**

The SAM Basic™ trainer engages the technology of the SimScope™ stethoscope to simulate adult heart, lung, and bowel sounds utilising a large sounds library. Using the provided SimScope™ stethoscope, users are able to access a large variety of pathological conditions in order to customise scenarios. By placing the SimScope™ over the anatomically correct locations of SAM Basic™, the programmed sounds will be played through the scope, allowing for students to employ and enhance their diagnostic skills.

Delivery includes a male manikin, a SimScope™, the SimScope™ software and site license, a USB cable, 1 SAM t-shirt and a user's manual.

**SAM Basic™ with WiFi**

Heart, lung and bowel sounds can be changed on the laptop and transmitted immediately to SimScope™ via WiFi connection.

**M-1020099**

**SAM Basic™ without WiFi**

Heart, lung and bowel sounds can be changed on the laptop and transmitted to SimScope™ via cable (included).

**M-1020097**



**SimScope WiFi™ The Hybrid Simulator**

The new SimScope WiFi™ enables wireless communication between the Simscope™ and the computer, allowing a seamless selection and change of pathological sounds and conditions of any standardized patient, O.S.C.E. or low-fidelity manikin.

- SimScope Patches™ are customisable and easily programmable for specific diagnostic case studies
- SimScope™ plays the programmed heart, breath and bowel sounds specific to each correct anatomical location enabling a realistic standardized patient encounter. Up to 15 patches may be programmed and simultaneously activated to simulate real time auscultation during a physical exam

Delivery includes: SimScope™, 7 sets of SimScope Patches™, SimScope Software™ and USB cable.

**M-1020104**

**SimScope™ The Hybrid Simulator without WiFi**

All features of M-1020104 but connects to a computer with a USB cable (included), not Wi-Fi. Delivered with a SimScope™, SimScope Patches™, SimScope Software™ and USB cable.

**M-1020101**

**Optional Extras:**

**Additional SimScope WiFi™ stethoscopes**

**M-1020105**

**SimScope Patch™ Kit (set of 15)**

**M-1020103**



**› DEVELOP YOUR OWN PRE-PROGRAMMED LECTURES!**

**CardioSim® VII, portable version**

The CardioSim® VII is the only system available that allows an instructor to create custom simulated heart sounds: Editing of S1, S2, murmurs, clicks, third and fourth heart sounds, heart rate, etc. allows the instructor to accentuate the particular aspects of the sound that is being studied. CardioSim® VII comes with hundreds of simulated and live recorded sounds, built-in heart animations, ultrasound live video images, and dissection slides provide an extensive library of information.

- Animations – There are over 125 animations on the CardioSim® VII. For example, in studying mitral stenosis the student can view a calcified mitral valve or watch an animation of mitral stenosis in a beating heart
- Images – The CardioSim® VII includes many images. Instructors can add their own slides and images, if desired
- Expanded Real Heart Sound Library
- The Real Heart Sounds Library has been expanded to approximately 200 real heart sounds
- Preprogrammed Lectures – To present a lecture, sounds (both simulated or real) can be preprogrammed. Each may have as many as eight lectures.
- New simulated sounds – The library of simulated sounds has been expanded to provide a variety of comparisons such as the difference between a split S2, OS and S3

**M-1020108**

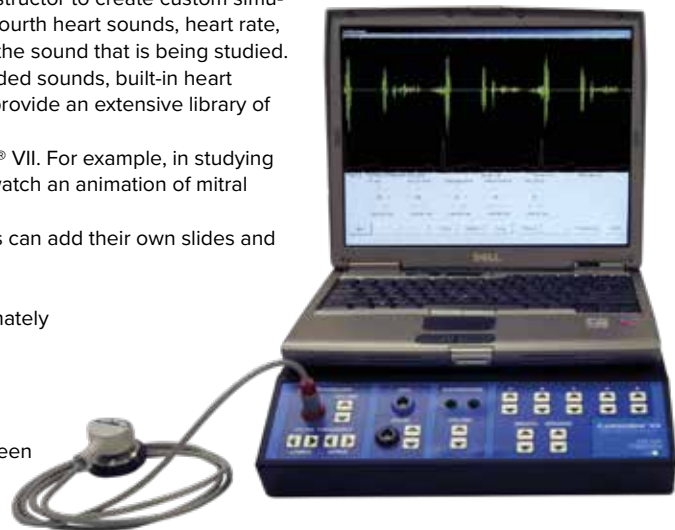





➤ PLEASE TAKE A LOOK AT THE TABLE BELOW TO FIND THE AUSCULTATION TRAINER THAT BEST FITS YOUR REQUIREMENTS

	SAM 3G®	SAM II	SAM Basic™	SAM Basic™ without Wifi	PAT™ Pediatric Auscultation Trainer	PAT Basic™	PAT Basic™ without Wifi
Item No.	M-1021554	M-1020095	M-1020097	M-1020099	M-1020096	M-1020098	M-1020100
<b>Hardware</b>							
Laptop with a pre-installed software	✓	✓	–	–	✓	–	–
<b>Stethoscope used</b>	any stethoscope	any stethoscope	SimScope™ Wifi	SimScope™	any stethoscope	SimScope™ Wifi	SimScope™
Carotid pulse	✓	✓	–	–	–	–	–
Can be connected to the Speaker System M-1021753 for group instruction	✓	✓	–	–	✓	–	–
<b>Auscultation sites</b>							
Heart	4	4	4	4	4	4	4
Lung	8	8	8	8	8	8	8
Bowel	2	2	2	2	2	2	2
Bruit	1	1	1	1	1	1	1
<b>Auscultation sounds</b>							
Heart	49	35	18	18	37	25	25
Lung	34	24	19	19	17	12	12
Bowel	11	11	5	5	4	4	4
Bruit	6	6	0	0	0	0	0
<b>Software</b>							
Phonocardiogram (recording of all heart sounds during a cardiac cycle)	✓	✓	–	–	✓	–	–
Sounds in the Real Sound Library	24	0	0	0	0	0	0
Echo Cardiogram Videos	12	0	0	0	0	0	0
Case Videos	24	0	0	0	0	0	0
Users can create and save own videos	✓	–	–	–	–	–	–
Users can setup password protected lectures	✓	✓	–	–	✓	–	–



## ▶ TRAIN THE ORIENTATION WITH ANATOMICAL LANDMARKS TO FIND CORRECT AUSCULTATION LOCATIONS

### Adult Heart and Lung Sounds Torso

Utilising this torso, students will learn to find the correct location where a specific sound can be heard. They will use the anatomical landmarks to orientate themselves, and once the location is found, they will hear the appropriate sound through the stethoscope and/or external speakers.

#### Features:

- Full size adult torso with palpable anatomic landmarks
- Sensor network hidden beneath the skin
- Hear the appropriate heart or lung sound as bell of stethoscope is moved across the front and back of the torso
- Includes Virtual Stethoscope® with multiple heart and lung sounds
- An external speaker plugs into the Virtual Stethoscope® so a classroom can hear what the student hears
- Includes instruction manual and carrying bag

**M-1019857**

### Auscultation Trainer and SmartScope™

The torso manikin presents itself as a real patient without visible auscultation sites. The student must palpate to identify correct auscultation locations, and will hear different heart and lung sounds as the SmartScope™ is moved to different locations on the manikin.

The instructor selects from a menu of heart and lung conditions by wireless remote control. A diagnosis of the selected condition can be made by comparing the variations in sounds occurring at different sites. Lung sounds can be detected at 5 anterior, 10 posterior, and two midaxillary locations. Students can practise auscultation at six anterior heart sites.

- Invisible auscultation sites
- No internal speakers
- Completely wireless
- Palpable landmarks
- Remote controlled
- Heart and lung sounds vary at different sites
- Hard storage case included

Listen to the sounds either using headphones or the SmartScope™ or by connecting to an amplifier (optional) or speaker (not included).

Range on the unit is up to 100 feet of remote access.

69 x 43 x 28 cm; 12 kg

**M-1005642**

### Trainer with Amplifier

**M-1018149**

### Additional Body

**M-1005644**

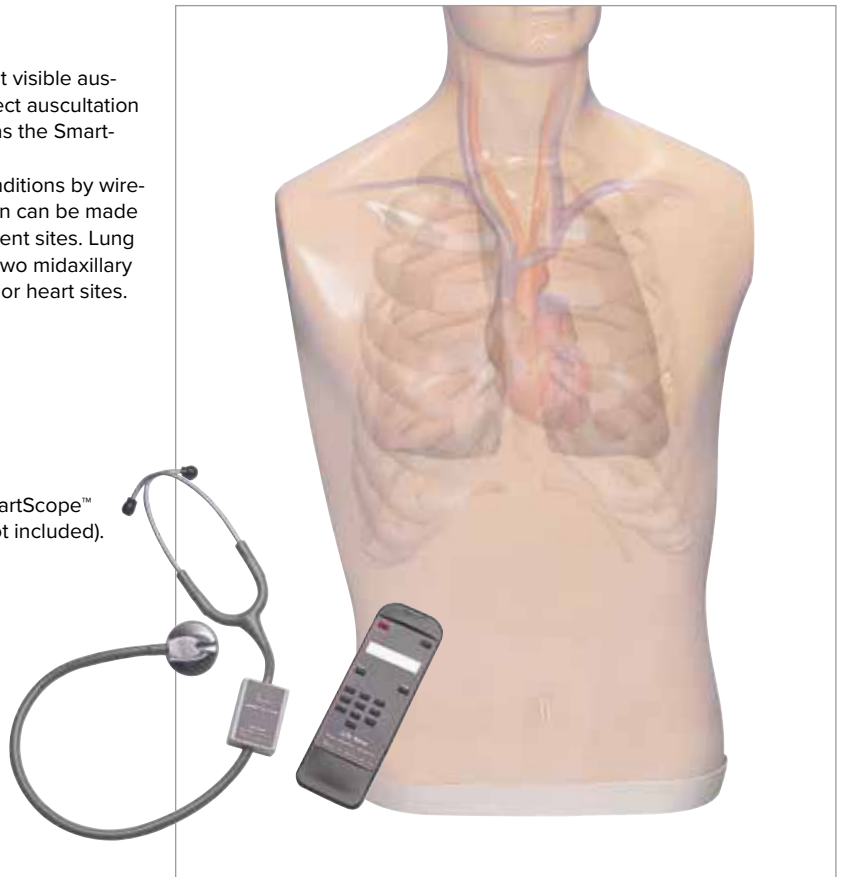

## ➤ CHOOSE FROM THE EXTENSIVE SOUND LIBRARY TO PRACTISE AUSCULTATION SKILLS!

### Arrhythmia, Heart & Breath Sounds TUTOR

Two-in-one TUTOR reproduces digitally stored heart and breath sounds or arrhythmias. This unique TUTOR allows instructors the flexibility to change menus by using plug-in modules. There is a volume control and two LEDs that illuminate during systole as well as an illuminated display showing the example currently playing. Sound Menu items are selected from the 16-panel keypad. Rhythms may also be viewed on any monitor or by connection to the Arrhythmia Display Interface.

Includes 2 stethoscopes from Sounders. Up to 50 Sounders can be connected at the rear panel jacks.

Sound menus sold separately, see table: Sounds libraries.

**M-1017976**

#### Recommended Item:

**Arrhythmia Display Interface**

**M-1018150**



**Additional Stethoscope Sounders**  
**M-1005892**

Sound Libraries	Item No.
Basic Heart Sounds	M-1018175
Murmurs	M-1018176
Breath Sounds	M-1018177
Paediatric Breath Sounds	M-1018178
Paediatric Heart	M-1018179
Infant Heart & Breath Sound	M-1018180
Rates and Rhythms	M-1018181
ACLS – Advanced Cardiac Life Support	M-1018182
ACLS II – Advanced Cardiac Life Support	M-1018183
CCU/ICU	M-1018184
CCU/ICU II	M-1018185
CCU/ICU III	M-1018186
Acute Myo-Infarcts Massive Anterior	M-1018188
Paced Beats	M-1018189
Paediatric PALS	M-1018190
Mitral Valve Disease	M-1018191
Aortic Regurgitation	M-1018192
Congenital Heart Disease	M-1005891
Cardiomyopathies	M-1018193
Mitral Stenosis Moderately Severe	M-1018194

### Heart & Breath Sounds Simulator

The portable TUTOR is a hand-held device that generates both heart and breath sounds. By utilising stethoscope Sounders students can auscultate at the same time or connect a speaker to broadcast the actual patient heart and breath sounds. The unit has two lights that illuminate during systole (heart menu) and expiration (breath menu). Includes 2 stethoscope sounders. Sound menus sold separately, see table: Sounds libraries.

**M-1005884**

Sound Libraries	Item No.
Basic Heart Sounds	M-1005885
Basic Murmurs	M-1005886
Breath Sounds	M-1005887
Paediatric Breath & Heart Sounds	M-1005888
Paediatric Heart Sounds	M-1005889
Infant Heart & Breath Sounds	M-1005890
Bowel Sounds	M-1018195



# TRANSESOPHAGEAL ECHOCARDIOGRAPHY (TEE)

## MrTEEmothy®

Transesophageal echocardiography (TEE) is one of the main diagnostic tools of contemporary cardiology. It can provide high quality imaging due to the position of the probe in the esophagus, located close to the heart. However, obtaining clear diagnostic cardiac images is very demanding. It requires not only a detailed anatomical and clinical knowledge of the heart, but also the practical skills needed to properly manipulate the TEE probe. MrTEEmothy®, the Transesophageal Echocardiography (TEE) Simulator, provides an extremely realistic feeling, as is carrying out the procedure in a real patient. It uses the combination of the TEE probe connected with a phantom, with a unique software based on a three-dimensional dataset obtained from computed tomography (CT) images.



- + MrTEEmothy® advantages and innovation were confirmed by a European patent (EP2538398)
- + Suitable for training students, residents, cardiologists, anesthetists and intensive care specialists who want to obtain skills without discomfort and the risk of unnecessary harm to patients
- + Easily connected to a large monitor for a group training

### The advantages of MrTEEmothy®:

- Capability to use the CT data from a range of real patients with numerous pathologies
- Biplane option showing two simultaneous sections steered independently – as in contemporary 3D echo machines
- An advanced game-like module can be used to practice and test the ability to obtain the standard TEE views recommended by the imaging guidelines
- Anatomical differences from patient to patient allow the training of individual cases
- Realistic feeling of the probe operation in a patient thanks to the unique software based on a three-dimensional dataset obtained from CT

### Training benefits:

- Operating trackball, buttons and knobs of the optional USB ECHO Panel
- Learning the TEE normal and pathological anatomy
- Pointing anatomical details with color markers positioned in three-dimensional space
- Practicing optimal acquisition and recording of standard TEE views
- Interpretation of individual pathology
- Performing measurements

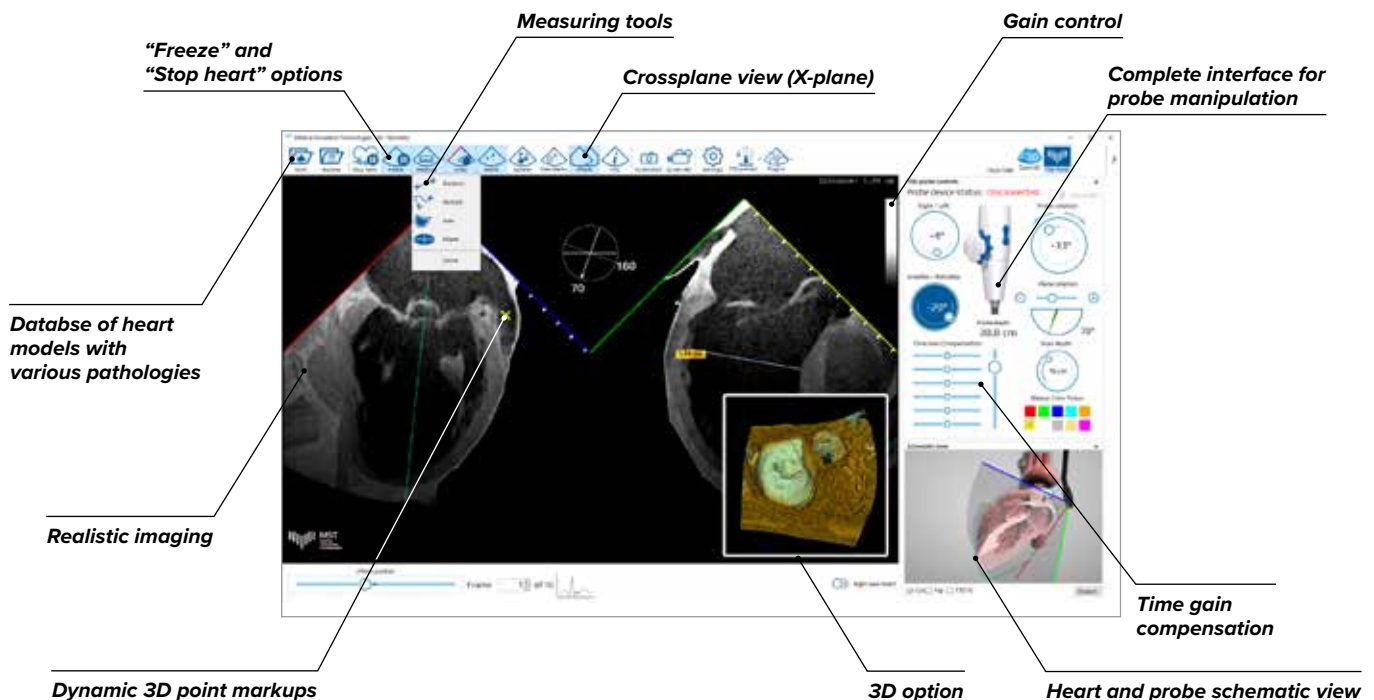

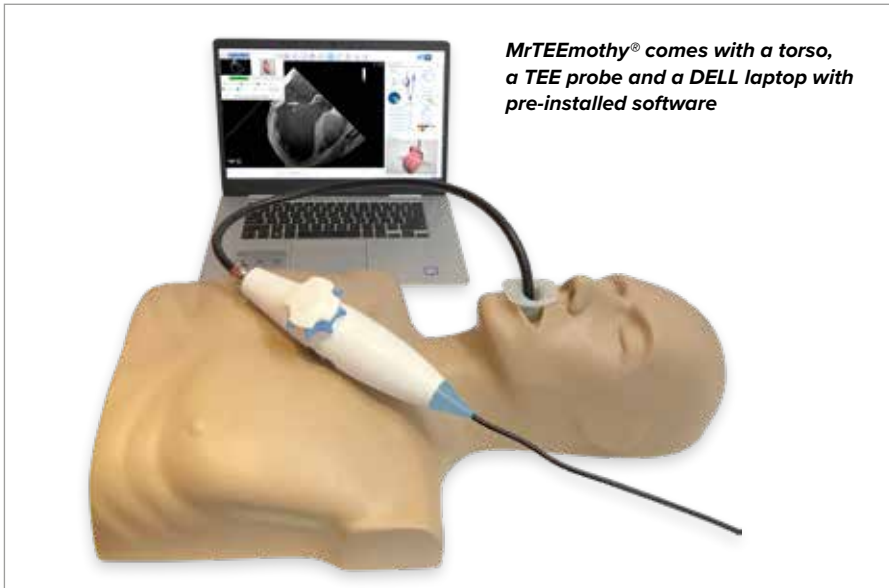

Hard-case transportation case included with each model



MrTEEmothy® is composed of a phantom and a TEE probe, connected to a dedicated laptop (included) by a USB cable. Advanced software and 3D visualization were specifically developed for the CT scan dataset. The screen interface shows not only 2D cross-sections similar to TEE images, but also the components of the probe motion such as probe depth, bends, rotation or the angle of the imaging plane.

The device is used with a laptop therefore is fully mobile and can be taken to any teaching location. It is easily connected to an external monitor, which allows for a simultaneous training of many students.

**MrTEEmothy® Standard M-1022128**  
**MrTEEmothy® Expert M-1022130**

	MrTEEmothy® Standard	MrTEEmothy® Expert
<b>Item No.</b>	<b>M-1022128</b>	<b>M-1022130</b>
<b>Hardware</b>		
MrTEEmothy® torso	✓	✓
TEE simulation USB probe (accuracy of ±0.5 mm in depth measurement and ±1° in plane rotation angle)	✓	✓
DELL laptop with pre-installed software	✓	✓
USB ECHO panel	-	✓
Transportation case	✓	✓
Warranty	one year for hardware	two years for hardware and software
<b>Software</b>		
2D and cross-plane imaging	✓	✓
Measurements package	✓	✓
Probe position indicators	✓	✓
3D animation to assist with probe and plane orientation	✓	✓
User color markers	✓	✓
Trainer with examination module	-	✓
Color flow module	-	✓
3D TEE viewer simulator	-	✓
<b>Cases</b>		
One normal and one pathology case	✓	✓
Additional 4 pathology cases	-	✓

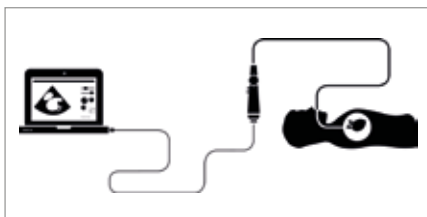

Combination of a TEE probe with a phantom and a unique software based on CT images



ECHO panel allows to control the simulator like a real ECHO machine



## PATIENT SIMULATION AND MOBILE DEBRIEFING

Debriefing is one of the most relevant parts of medical simulation training. REALiTi is a smart and highly advanced patient monitor simulator that mimics proprietary monitors and defibrillators and is shown on page 15.

### CTGi – Fetal Heart Rate Monitor Simulator

CTGi is an economical, highly advanced and realistic fetal heart rate monitor simulation package. The lightness and simplicity, using just two iPads®, makes the CTGi ideal for in-situ training.

#### Features of the CTGi Fetal Heart Rate Simulator:

- Realistic function & detail – CTGi allows you to create realistic traces with exceptional detail. Manage maternal vitals, easily add decelerations, accelerations as well as contractions. Pause, rewind and fast forward with a swipe
- Versatile – CTGi can be used in many different teaching modalities, its interface is incredibly realistic with an interactive control iPad® to create traces easily
- Capability – Turn a low fidelity situation into high fidelity simulation. Name, save and replay scenarios and traces for teaching

Contact us for more information



## ➤ YOUR CUSTOMIZED SIMULATION SOLUTION!

Please work with our configuration assistance to pick and choose your simulation packages, software features, and hardware.



### ALSi – The Advanced Patient Condition Simulation

Using just 2 iPad® tablets, the lightness and simplicity of ALSi makes it ideal for in-situ training. ALSi gives facilitators a great tool for training and students an incredibly realistic platform to learn from. ALSi offers medical simulation as you've never seen it before, built off technology you use every day.

#### Features of ALSi:

- Realistic and reliable – Trainees view the simulated monitor on one iPad® while the instructor supervises, manages and controls the training on the facilitator iPad®
- Portable – Custom designed bag gives the look and feel of a real monitor or defibrillator and can be used anywhere
- Economical and versatile – ALSi provides highly advanced simulation for far less than the cost of traditional systems and is always up to date
- Simply advanced – iSimulate developed ActiveWave as the next step in advanced waveform technology. ActiveWave delivers clearer, crisper and more flexible waveforms than ever before

**Contact us for more information**

## › YOUR CUSTOMIZED SIMULATION SOLUTION!

Please work with our configuration assistance to pick and choose your simulation packages, software features, and hardware.

### ALSi Upgrade to REALTi

iSimulate offers all ALSi customers the cost-effective option to upgrade to REALTi. Keep the features of ALSi, but expand your monitor views with any of the available proprietary screens and have the flexibility to switch to another monitor surface without additional hardware. You will have more options at your disposal. REALTi can be extended at any time with modules such as CPR feedback and Video Recording. With iSimulate you get professional products at a fair price.

**Are you an existing ALSi customer? Contact us about your upgrade possibilities to REALTi.**



### AURiS Auscultation Trainer – Simulation stethoscope with advanced sensor technology

This simulation stethoscope is connected wirelessly with a mobile device and controlled via the **AURiS app**. The main menu allows you to create, change and save scenarios, as well as to manage the stethoscope. The AURiS app is available in your App store for iPhone®, iPad®, and iPod® touch.



#### Realistic stethoscope and real sounds

Heart, lung, bowel and bruit sounds all included. The student only hears sounds when the stethoscope is placed on a body.

- Realistic look and sound
- 22 heart and 13 lung sounds
- Bruits and bowel sounds
- Custom scenarios can easily be added

#### Simple and Versatile

The instructor interface is easy to operate. Use AURiS on manikins and standardized patients to increase simulation fidelity.

**Contact us for more information**

# EAR AND EYE EXAMINATION

## › INTRODUCING THE NEW STANDARD OF EXCELLENCE IN OTOLARYNGOLOGY SIMULATION AND TRAINING TECHNOLOGY!

### OtoSim 2™ Otoscopy Training

Developing diagnostic skills in otoscopy is challenging for all learners - OtoSim 2™ brings verifiable learning to otoscopy training. The tracked otoscope interacts with a library of normal ear anatomy as well as hundreds of pathologies. By using OtoSim 2™, students can be trained in diagnosing and treating ear pathologies. The software includes 380 high-resolution images from the Hawke Library which give many possibilities to instruct, practice, and test their otoscopic diagnostic skills.

#### **OtoSim 2™ content and skills features include:**

- Instrument Use
- Feature Identification
- Pathology
- External Auditory Canal - Acute Otitis Externa, Cerumen, Foreign Bodies, and more
- Middle Ear - Normal Tympanic Membrane, Temporal Bone Fractures, Acute Otitis Media, Serous Otitis Media, Tympanocentesis, Myringotomy, and more
- Self-Examination and Anatomy Examination (advanced quizzes with randomized, realistic clinical scenarios)
- Pneumatic Otoscopy - Simulated slides to enhance students' pneumatic otoscopy skills (available with purchase of PneumatoSim™ M-1021952)

**M-1021950**



## › YOU CAN UPGRADE THE OTOSIM 2™ OTOSCOPY TRAINING WITH THE FOLLOWING ADD-ONS:

#### **PneumatoSim™ Pneumatic Otoscopy Upgrade Kit**

Add-on to the OtoSim 2™ which focuses on pneumatic otoscopy. Through hands-on insufflation and otoscopy experience, students can enhance their skills and confidence in using a pneumatic otoscope.

**M-1021952**



#### **Eye Upgrade Kit for OtoSim 2™**

Hardware and software upgrade which mounts on your existing OtoSim 2™ and allows you to enjoy the benefits of OphthoSim™

**M-1021951**



#### **Educators Toolkit™ for OtoSim 2™**

Software upgrade with set of 3 applications (image creator, image annotator and slide presenter) that allows healthcare educators to customize their simulation training sessions.

**M-1021953**



**ACCURACY IN THE DIAGNOSIS OF VARIOUS EAR PATHOLOGIES INCREASED FROM 54% TO 78% – GO TO 3BSCIENTIFIC.COM TO SEE THE VALIDATION STUDY!**





## OphthoSim™ Ophthalmoscopy Training

OphthoSim™ Ophthalmoscopy Training is a hands-on simulation system that radically transforms how students learn to diagnose and treat eye pathologies. Its proprietary software and accompanying tools empower students to actively diagnose real-world eye conditions within a simulated environment.

Students can use OphthoSim™ to get better at diagnosing and treating eye pathologies. They can practice identifying retinal features and monocular vision as well as improve their ophthalmoscopic and fundoscopic technique. OphthoSim™ Ophthalmoscope detects user movements and orientation, whereas the included eye piece replicates the magnification of lens in the human eye and duplicates its different clinical conditions.



### **OphthoSim™ software includes:**

- Training and testing modules with database of 200 High Resolution Images
- Detailed text descriptions and pre-annotations for normal landmarks and pathological features
- Landmarking Function - allows instructor to highlight specific characteristics of pathologies
- Advanced Quizzes - Randomized realistic clinical scenarios to test both medical and patient interaction skills
- Easy-to-use Graphical User Interface - Improves viewer retention through immersive full-screen experience

### **OphthoSim™ content and skills features:**

- History of Ophthalmoscopy
- Examination Principles & Technique
- Instrument Use
- Retinal Feature Identification
- Pathology - Papilledema, Diabetic Retinopathy, Glaucoma, Choroidal Rupture, Macular Degeneration, plus more
- Examinations and Self-Examinations

**M-1021954**

## ➤ YOU CAN UPGRADE THE OPHTHOSIM™ OPHTHALMOSCOPY TRAINING WITH THE FOLLOWING ADD-ONS:

### **Ear Upgrade Kit**

Hardware and software upgrade which mounts on your existing OphthoSim™ and allows you to enjoy the benefits of OtoSim 2™.

**M-1021955**



### **Educators Toolkit™ for OphthoSim™**

Software upgrade with set of 3 applications (image creator, image annotator and slide presenter) that allows healthcare educators to customize their simulation training sessions.

**M-1021956**



MORE INFORMATION ON NEXT PAGE

“ 95% of graduating medical students do not feel comfortable with their level of otology skills at the end of their clerkship. ”

Many professionals can relate to this in reflecting on the inadequacies of their otoscopy training. There is a need to fix this! Following a three-hour group session using OtoSim™ Otoscopy Training & Simulation System, medical students increased their accuracy in the diagnosis of various ear pathologies from 54% to 78%.



➤ PLEASE TAKE A LOOK AT THE TABLE BELOW AND FIND THE SIMULATOR THAT BEST FITS YOUR REQUIREMENTS

	OtoSim 2™ Otoscopy Training	OphthoSim™ Ophthalmoscopy Training	OtoSim 2™ and OphthoSim™ Set
Item No.	M-1021950	M-1021954	M-1022140
Base unit	✓	✓	✓
Instrument	OtoSim 2™ Otoscope	OphthoSim™ Ophthalmoscope	OtoSim 2™ Otoscope and OphthoSim™ Ophthalmoscope
Control Box	OtoSim 2™ control box	OphthoSim™ control box	OtoSim 2™ and Ophtho- Sim™ control box
Adult Earform	right and left	-	right and left
OphthoSim™ Eye	-	✓	✓
USB Cable	✓	✓	✓
Otoscope Cable	✓	-	✓
Ophthalmoscope Cable	-	✓	✓
Extra Speculums	✓	-	✓
Software (delivered on a USB stick)	OtoSim 2™ Software	OphthoSim™ Software	OtoSim 2™ and OphthoSim™ Software
Protective Hard Cases	two	two	three
User manual (delivered on a USB stick)	✓	✓	✓



Up to 14 OtoSim™ units can be connected to a single instructor laptop



Perfect tool for a group training

### Ear Examination Simulator

The ear examination simulator consists of a head with 6 interchangeable flexible ears with life-like external and internal structures of the ear. Embedded coloured prints in 5 out of the 6 ears allow the diagnosis of various pathologies. One ear is not coloured, but can be used for earwax removal exercises.

38 x 38 x 26 cm; 7.7 kg  
**M-1005645**

### Supplementary Ears

This set includes 4 ears which allow observation of chronic otitis media with large perforation, attic cholesteatoma, attic cholesteatoma, and atelectatic middle ear otitis and tympanosclerosis.

**M-1005646**



### Life/form® Diagnostic and Procedural Ear Trainer

Life-like right and left ears teach diagnostic and procedural techniques and are removable for easy maintenance and storage. For the ultimate in realism, the middle ear can be filled with various fluids. Trainer comes complete with two ears, approximately 100 pre-cut eardrums, specially formulated ear wax, one standard middle ear cartridge with syringe, adjustable stand, and a hard carry case. Otoscope, ventilation tubes, and surgical instruments are not provided. See online for additional product features.

45.7 x 27.9 x 25.4 cm; 5.44 kg  
**M-1017258**



### Option:

#### Life/form® Pneumatic Otoscopy Kit

This Pneumatic Otoscopy trainer offers an additional feature for the Life/form® Diagnostic and Procedural Ear Trainer (M-1017258 shown above). While pneumatic otoscopy is indispensable for examination of the ear, studies have shown that most are performed incorrectly! Now with the valuable feedback offered by this kit, students, residents, and practising physicians can learn how to generate the correct amount of air pressure needed to perform accurate pneumatic otoscopy to test for tympanic membrane mobility. Kit includes a pneumatic pressure gauge, two pneumatic ears with pressure tubing, and a package of approximately 100 eardrums.

30.5 x 27.9 x 12.7 cm; 1.13 kg  
**M-1017259**

# VIRTUAL REALITY SIMULATORS

## › Voxel-Man ENT – Virtual Reality Training in ENT

Voxel-Man ENT is a complete VR Surgical Simulation System for temporal bone dissection, endoscopic sinus surgery and adding own cases from CT or CBCT. The system provides a versatile emulation of a surgical experience: the look, feel and tactile feedback are extremely close to the real intervention.

The VR simulation features both one and two-handed operation of instruments such as metal and diamond burs of different sizes and suction. The system offers predefined tasks, automatic skills assessment, visualization of learning curves, video capture as well as online updates. The trainee will quickly acquire a thorough understanding of the surgical anatomy and approaches, all within a safe learning environment.

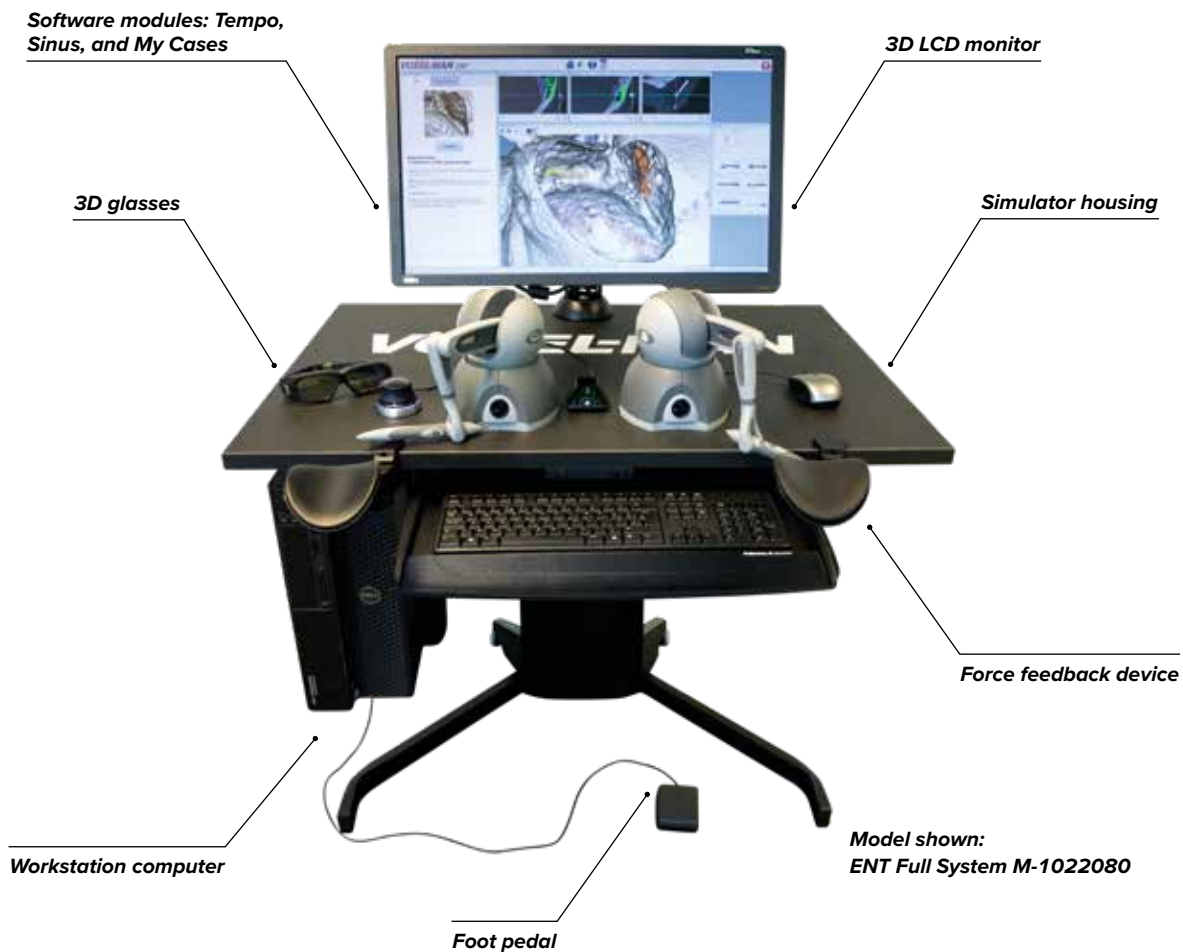

**Easy to use software**

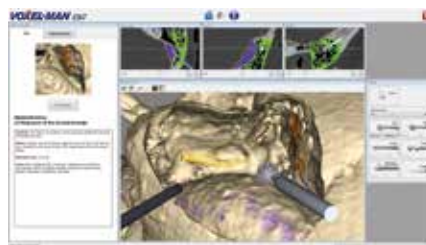

**Working on a surgical task**



**Inspection of learning curves**

**Tempo – the temporal bone drilling simulation:**

- Training cases of middle ear with different anatomy and pathology
- Structures at risk such as facial nerve, tympanic chord, vestibular labyrinth, cochlea, auditory ossicles and dura are highlighted
- Optional support function provides automatic alerts
- Permanent tracking of instrument movements
- Automatic skills assessment provides immediate and objective feedback of performance
- Automatic video capture of session provides additional insights
- Learning curves of individuals and groups help monitor and compare progress over time

**My Cases – new simulations based on own data:**

- Upload own clinical or research data from CT or CBCT to create new specialized training cases
- System provides a bone model ready for drilling within minutes
- 3D anatomy may be further enhanced with structures at risk, identified using an advanced interactive segmentation approach
- Your cases can reach the same functionality as predefined training cases

**Sinus – the endoscopic sinus surgery simulation:**

- Allows for simultaneous handling of endoscope and a surgical instrument
- Provides straight and angular endoscopes and various instruments
- Structures at risk such as periorbita, optic nerve, optic chiasm, ethmoidal cells, olfactory bulb and internal carotid artery are highlighted
- Virtual surgical navigation system provides additional cross-sectional CT images

**M-1022080**

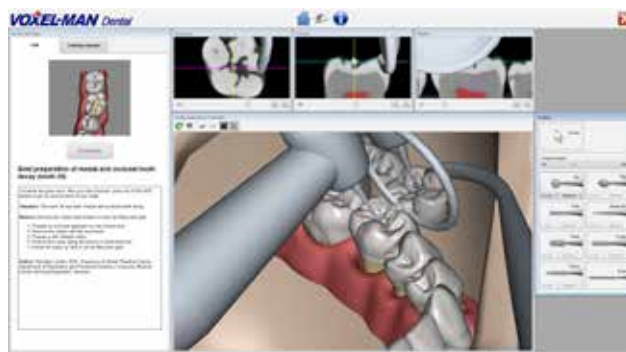

**Voxel-Man Dental – Virtual Reality Training in Dentistry**

The dental VR simulation features teeth and instruments visualized on a 3D screen, both one and two-handed operation of instruments, a database of different pathologies, automatic skills assessment and monitoring of progress.

- High resolution tooth models derived from real teeth by microtomography
- Dental hand piece is represented by force feedback device which can be moved in three dimensions
- Dental models include carious lesions at various locations, such as mesial, occlusal, and distal tooth decay
- Instruments include a selection of high and low speed burs of different shapes which are controlled by a foot pedal, as well as a dental mirror

**M-1022081**

**▶ PLEASE TAKE A LOOK AT THE TABLE BELOW TO CHOOSE THE VIRTUAL REALITY TRAINER THAT BEST FITS YOUR REQUIREMENTS**

	ENT Basic System	ENT Full System	Dental Full System
Item No.	M-1022079	M-1022080	M-1022081
<b>Hardware</b>			
Workstation computer	✓	✓	✓
3D LCD Monitor	✓	✓	✓
Two pairs of 3D glasses	✓	✓	✓
Force feedback device (handle)	1	2	2
Space navigator	✓	✓	✓
Foot pedal	✓	✓	✓
Simulator housing with two arm rests and electrically adjustable height	-	✓	✓
<b>Software modules</b>			
"Tempo" for temporal bone drilling exercises	✓	✓	-
"My Cases" for adding new simulations based on own CT or CBCT data	✓	✓	-
"Sinus" for endoscopic sinus surgery exercises	-	✓	-
Two-handed operation with bleeding and suction	-	✓	-



## SECTRA – EDUCATION PORTAL, TABLE AND BOARD

A global education system to promote problem based clinical learning in the anatomy curriculum

SECTRA is one of the world's leading providers of IT systems for managing medical images and patient information with more than 1,800 installations worldwide.

The Education Portal builds on this global network and gives teachers and students a powerful tool for interactive, problem-based learning.

The extensive library of real patient cases and the complete human anatomy atlas can be accessed from any touch device.

Empower clinical thinking and collaboration through anatomy, radiology, pathology, histology and embryology modules.

**Problem Based Learning:**

Enable students to transfer foundational concepts into clinical medicine with complete patient cases (fully anonymized rare and common pathologies). Integrated radiology and histology images with diagnostic quality.

**Stories:**

A collection of lectures and teaching content which allows users to create, organize and view prepared images and teaching material in Education Portal in one flow. Switch between 2D scans, 3D rendered images, bookmarks, histology, PDFs, videos, etc. from different cases and still interact fully with each image or slide.

**Unprecedented image quality:**

High resolution and full screen histology images with full range of capabilities (cell counting, zoom with different staining, measurements, layer focus, and more). You can also add realistic effects like light and shadows in the 3D reconstruction for additional visual clues.



**Access anywhere:**

SECTRA Education Portal works anywhere and on any device. It is a cloud-based system built on the powerful and globally established PACS radiology software. It is FDA and CE certified and includes automatic software updates.

**Global collaboration:**

Upload any DICOM data (anonymized) to securely share it with the global network or keep it in your private data space. Store and review clinical case, add your own annotations (in 2D and 3D), prepare classroom and exam files, and bookmark your current case.

Teacher and student licenses	Curriculum	Unique content
<ul style="list-style-type: none"> <li>• Easy way to share cases, generate URLs with a click of a button</li> <li>• Students have access from any touch device to study the cases</li> <li>• Teacher have access from any device and can prepare cases from the SECTRA PACS software</li> <li>• Students can follow the teacher's screen on their device while the presentation is synchronized in real time. They can also request control of the screen to share their questions and answers</li> </ul>	<p><b>Anatomy curriculum with Radiology images developed with Monash University plus entire anatomy lessons from Virtual Human Dissector (VHD):</b></p> <ul style="list-style-type: none"> <li>• Anatomy Pathways</li> <li>• Virtual Edge</li> <li>• Cadaver Dissection Guide</li> <li>• Surface Palpation Guide</li> <li>• The Anatomy of clinical procedures</li> <li>• Radiology library related to 3D anatomy</li> <li>• Muscle Tables</li> <li>• WELLS Center Clinical Skills</li> </ul>	<ul style="list-style-type: none"> <li>• 4D videos of CT</li> <li>• Histology</li> <li>• Complicated cases</li> <li>• Veterinary cases</li> <li>• Integrated cases (pathology + US + photo + RX + MMG)</li> <li>• Comparison cases</li> <li>• New imaging technique cases (7Tesla MR)</li> </ul>



**SECTRA Table and SECTRA Board**

Reliable touchscreen hardware enables working groups and larger audiences to collaborate and learn interactively. The Board has a larger screen and will be mounted to a wall while the slightly smaller screen of the Table allows it to be moved between classrooms. Please note: the Education Portal software can only be purchased in combination with either SECTRA Board or SECTRA Table.

▶ PLEASE TAKE A LOOK AT THE TABLE BELOW TO CHOOSE BETWEEN THE SECTRA BOARD OR TABLE

	SECTRA Board	SECTRA Table
Item No.	M-1020935	M-1021917
<b>Hardware</b>		
Screen	86"	65"
Resolution	UHD	4K QLED UHD
Touch method	InGlass™ 20 touch-capacitive screen	QLED 10 touch-capacitive screen
Screen tilt	90°	0 – 90°
Can be used as	a blackboard or with a stand	a motorized stand with wheels and adjustable height
Possibility to mount on a wall	✓	-
Adjustable height	-	✓
Dimensions (W x H x D)	216 x 145 x 29 cm	155 x 118 x 921cm ( in table position)
Weight	88 kg	220 kg
<b>Software</b>		
Software updates	done automatically, free of charge within the license period	
Software certificates	FDA and CE	
Cloud-based	✓	
Import own histology data as well as CT and MRI scans	✓	
3D rendering	✓	
Add comments, bookmarks and annotations in 2D and 3D	✓	
Orthopedic surgery planning tool	via SECTRA 3D Trauma optional	
PowerPoint viewer	✓	
Anatomy curriculum with Radiology images developed with Monash University	✓	
Can be used for clinical diagnostics	yes, SECTRA is one of the world's leading providers of IT systems for managing medical images	
Best in KLAS award	✓	



### Greater access to clinical cases through SECTRA Education Portal

In 2017, Hanze University of Applied Sciences Groningen (UAS) implemented SECTRA RIS and PACS to enable its Medical Imaging and Radiation Therapy program (MIRT) to better mimic the clinical workflows in its teaching. Hanze UAS also has access to the SECTRA Table, a multi-touch display workstation that lets teachers and students access clinical cases through the cloud-based service SECTRA Education Portal for engaging group lessons and lectures.

“SECTRA understood the challenge we face as an educational institution. We were looking for a system that would enable us to prepare our students for their future in the hospital, and one that would allow the teachers to easily handle assignments.”



Jornt de Vries, radiology lecturer and manager of the RIS/PACS at Hanze UAS

### New feature: Stories

The new feature, stories is an inspirational framework from the clinical real world for your courses, ready to use. It is a collection of lectures and teaching content which allows users to create, organize and view prepared images and teaching material in Education Portal in one flow. Professors, Teachers and Students can quickly and easily:

- Switch between 2D scans, 3D rendered images, bookmarks, histology, PDFs, videos, etc. from different cases and still interact fully with each image or slide.
- Add specific instructions or information in your own language to each story slide
- Find inspiration and opportunities for collaboration worldwide from publicly shared Stories
- Show the variations between real patients with different pathologies

Hardware	Software	Item No.
SECTRA Table	1 year Education Portal	M-1021917
SECTRA Board	1 year Education Portal	M-1020935
SECTRA Table	3 years Education Portal	M-1021918
SECTRA Board	3 years Education Portal	M-1020937
SECTRA Table	5 years Education Portal	M-1021919
SECTRA Board	5 years Education Portal	M-1020939

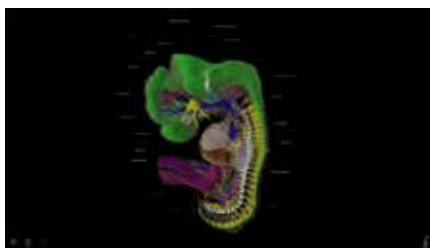

NEW! Embryology images



Radiology images



Stories

### ➤ SCHEDULE A DEMO WITH YOUR LOCAL 3B SCIENTIFIC SECTRA TEAM:

Please contact the 3B Scientific Customer Service for more information and to schedule a personal product demonstration:

Phone: +49 (0)40 739 66-0  
Email: [info@3bscientific.com](mailto:info@3bscientific.com)



# HUMAN ANATOMY

3B Scientific has been setting quality standards in manufacturing didactic material for medical education since 1948.

Today, the brand is represented in over 120 countries worldwide with local offices in Brazil, China, France, Germany, Hungary, Italy, Japan, Russia, South Korea, Spain, Thailand, Turkey, United Kingdom and USA.

3B Scientific is a member of the Worlddidac Quality Charter and its quality management is certified according to the standards of DIN EN ISO 9001.



***The quality standards upheld in every 3B Scientific® product are guaranteed by permanent and uncompromising controls.***

3B Scientific offers you the highest level of service and product quality that you can always depend on. The production of our 3B Scientific® anatomy models, simulators and trainers is backed by the newest findings in medical sciences and educational techniques.

***A wide selection of products is available to fit your exact needs:***

- All life-size skeletons and some soft tissue models are cast from real specimens
- Made from extremely durable materials for everyday use
- Designed and developed in Germany for medical professionals
- All original 3B Scientific® anatomy models now include the 3B SMART ANATOMY course and a free warranty extension from 3 to 5 years

Precise anatomical details are hand painted to show intricate structures such as muscle and nerve fibres. These allow for easy identification in our detailed product manuals and learning cards whilst encouraging effective teaching and interactive study.

Only non-toxic material is used to create models for everyday, hands-on education. The casting process, from real specimens, guarantees realistic anatomical features and life-like textures. Our production processes ensure that our exacting standards are always maintained for every single bone, skeleton, model and simulator. This is backed by the 3B Scientific warranty.



***Each model is hand-finished by highly trained and skilled technicians to ensure a consistently high quality.***

# COMPLETE ANATOMY

## ► EXPLORE HUMAN ANATOMY LIKE NEVER BEFORE!

The award-winning interactive Complete Anatomy app is a cross platform, multi-operating system software. The ultra-high performance of the 3D anatomy atlas across all devices is convincing customers all over the world to use Complete Anatomy for learning, teaching and presenting human anatomy. Explore human anatomy like never before on your preferred device wherever you are. Find out more at [3bscientific.com/AnatomyApp](http://3bscientific.com/AnatomyApp).



### Your cross platform 3D anatomy solution

Complete Anatomy is the most accurate and complex **3D anatomical atlas** available and it is entirely interactive. It works across platforms, so users can choose whether to use it as an app on their smartphone or tablet, or as desktop software when working on laptop or computer.

Users can **watch educational videos** about cardiology, dentistry, fitness, ophthalmology or orthopaedics and take a closer look at all the body systems, for example the muscular, lymphatic, nervous system and many more.

Complete Anatomy is **intuitive to use and fully interactive**. Users can study, teach and present in multiple different ways tailored to their needs as a student, educator or medical professional. The anatomy of the human body can be discovered layer by layer, structure by structure or function by function.

An academic advisory board and in-house **anatomical experts** from 3D4Medical continuously validate all anatomical data that is used in the anatomy app and desktop software, which makes it reliable for students and professors all over the world.

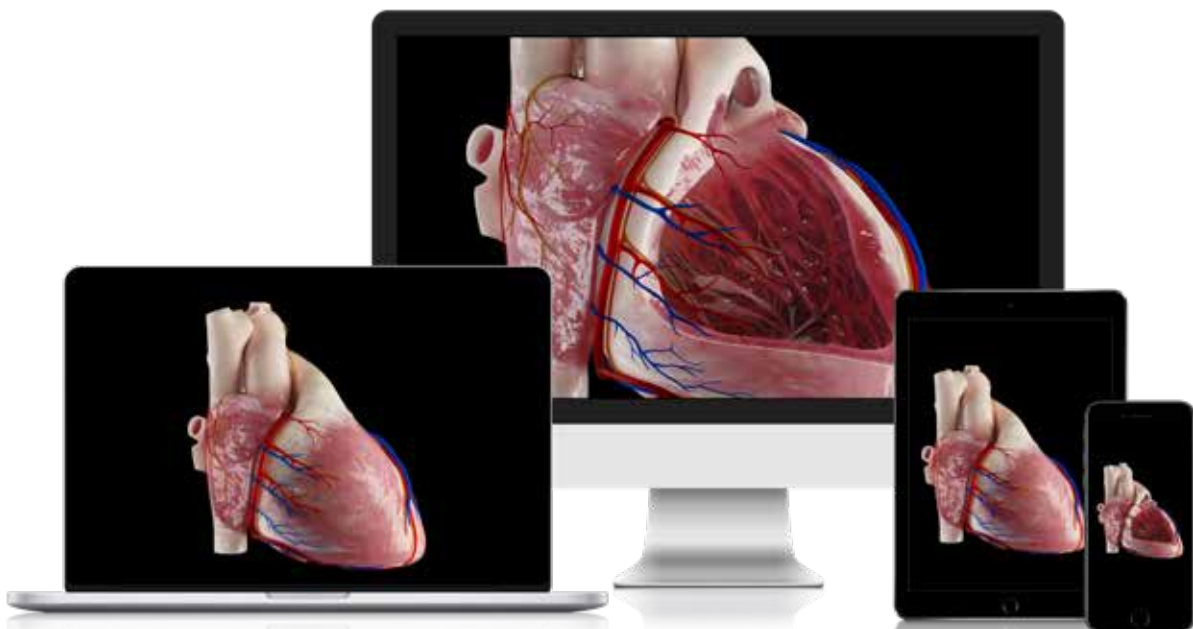

## Complete Anatomy Licenses

Complete Anatomy is available in English and in three different licenses, each tailored to the specific needs with tools to prepare entire anatomy courses (Educator), to use the app to study human anatomy as a student (Student Plus) or to use it to educate your patients (Professional).



### Student Plus License

Choose the Student Plus License for advanced learning and content sharing with an annual subscription. The Student Plus License provides you with accurate studying closest to a real human body. It helps you easily understand human anatomy including the functions of each anatomical structure and shows how they work together in body.

**M-10263**



### Professional License

Use the Professional License to educate your patients. Enhance your patients' understanding of their conditions by describing their anatomy or pathology in 3D by using the interactive nature of Complete Anatomy with animated and interactive anatomical models. Especially the included videos with standardized pathologies will allow you to further explain the implications of conditions and procedures effectively to your patient.

**M-10262**



### Educator License

Create and present entire courses and easily keep track of your students progress with the Complete Anatomy Educator License. As an Educator, use the library of anatomy courses delivered by leading experts in human anatomy, point of care ultrasound, cadaveric imagery as well as clinical correlates to save time in preparing your courses or create your own courses. Add your own content and additionally take advantage of the educator tools with the easy to use drag & drop curriculum.

**M-10261**



	Student Plus M-10263	Educator M-10261	Professional M-10262
Atlas	✓	✓	✓
Cross-Platform Access	✓	✓	✓
All Video Packs	✓	✓	✓
All 3D4Medical Courses	✓	✓	✓
Access Curriculum Content	✓	✓	✓
Presentation License		✓	✓
Patient Education License			✓
Send Curriculum Content		✓	
Curriculum Manager		✓	
AR (Augmented Reality)	✓	✓	✓



MORE INFORMATION AVAILABLE ONLINE AT  
[3BSCIENTIFIC.COM/ANATOMYAPP](https://3bscientific.com/anatomyapp)

# SKELETON MODELS



SCAN THE QR CODE ON P. 174 FOR A FREE  
3B SMART ANATOMY DEMO VERSION

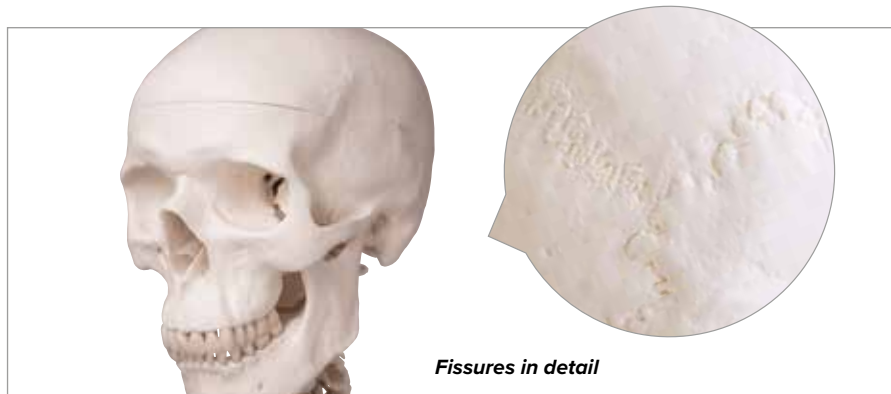

**All 3B Scientific human skeleton models offer highest quality in workmanship and materials!**

- Life-size and realistic weight
- Top quality cast from real specimens
- Extremely accurate in every detail, final assembly carried out by hand
- Made from a durable, unbreakable synthetic material
- 3 part assembled skull with magnetic connections
- Limbs can be removed quickly and easily
- Movable joints for demonstration purposes
- On a stable metal stand with 5 wheels for secure transfer from room to room
- Transparent dust cover included
- Developed in Germany
- Includes 3B SMART ANATOMY

## Stan the Classic Human Skeleton Model

The Classic Skeleton Model Stan has been the standard of quality in hospitals, schools, universities, and laboratories for over 50 years. Stan is the most affordable full-size skeleton of this quality available anywhere, ideal for active use in teaching and demonstrations. This human skeleton model is easy to handle, anatomically correct (cast from real specimen) and economically priced.



High quality human skeleton models,  
cast from a real specimen

### 3B SMART ANATOMY

#### Stan on Pelvic Mounted Roller Stand

176.5 cm; 9.57 kg

**M-1020171**

### 3B SMART ANATOMY

#### Stan on Hanging Stand (Hanging Stand shown on page 181)

192.5 cm; 8.77 kg

**M-1020172**

### Recommended: Heavy Duty Protective Cover, Black

Protect your investment with our heavy-duty protective cover.  
Suitable for all 3B Scientific full-size skeletons.

**M-1020761**



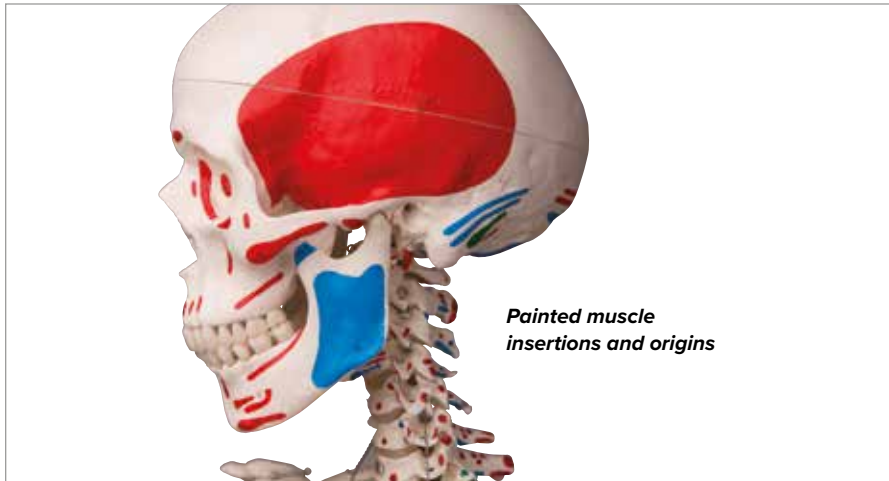

### Max the Classic Skeleton with Muscle Insertions and Origins

This skeleton contains all the standard benefits of a 3B Scientific® Skeleton plus painted muscles, to demonstrate the structural interaction between bones and muscles. It depicts over 600 structures of medical/anatomical significance including muscle origins (red) and insertions (blue) on the left side as well as hand numbered bones, fissures and foramina on the right side.

## ➤ MAX GOT MUSCLE!

### *All features exclusive to Max at a glance:*

- Shows the structural interaction between bones and muscles
- Depicts over 600 structures of medical significance
- Painted muscle origins in red and insertions in blue
- Hand numbered muscles, bones, fissures and foramina for easy identification
- Includes 3B SMART ANATOMY



Demonstrate the structural interaction between muscles and bones with Max

### 3B SMART ANATOMY

#### Max on Pelvic Mounted Roller Stand

176.5 cm; 9.57 kg

**M-1020173**

### 3B SMART ANATOMY

#### Max on Hanging Stand (Hanging Stand shown on page 181)

192.5 cm; 8.77 kg

**M-1020174**





### Leo the Classic Skeleton with Elasticated Ligaments

This skeleton contains all the standard benefits of a 3B Scientific® Skeleton plus ligaments to represent the structural interaction between bones and ligaments. The elasticated ligaments on the major appendicular joints (shoulder, elbow, hip, and knee) are mounted on the right side.

### ➤ LEO IS ALL ABOUT LIGAMENTS!

#### *All features exclusive to Leo at a glance:*

- Structural representation of interaction between bones and ligaments
- All ligaments are elasticated to show movement
- Includes 3B SMART ANATOMY

#### **3B SMART ANATOMY**

#### **Leo on Pelvic Mounted Roller Stand**

176.5 cm; 10 kg

**M-1020175**



Demonstrate the interaction between bones and ligaments and realistic movement with Leo

*Elasticated knee ligaments*







Over 600 labeled details



Emerging spinal nerves



Sam is your all-purpose teaching tool for all levels of student or patient education

**Sam the Classic Skeleton with Elasticated Ligaments, Labels, Muscle Insertions and Origins**

This skeleton contains all the standard benefits of a 3B Scientific® Skeleton plus a bendable vertebral column, ligaments, painted muscles and over 600 labeled and identified structures. Sam's fully flexible vertebral column allows you to demonstrate all natural postures, including the movements of the skull and head joints. The unique combination of a flexible vertebral column, muscle origins and insertions, numbered bones, flexible joint ligaments, and a disc prolapsed between the 3<sup>rd</sup> and 4<sup>th</sup> lumbar vertebrae allow you to display over 600 structures of medical/anatomical interest with this top of the line model. Comes complete with an identification guide.

**Sam the Super Skeleton does it all:**

- Over 600 hand-numbered, labeled details, includes detailed guide for easy identification
- Hand-painted muscle origins and insertions
- Flexible spine and ligaments for natural postures (can be removed from stand)
- Slipped disc between the 3<sup>rd</sup> and 4<sup>th</sup> lumbar vertebrae
- Protruding spinal nerves and vertebral arteries
- Full flexibility of limbs on left side, right side has full flexibility of knee and hip with limited flexibility of elbow and shoulder
- Includes 3B SMART ANATOMY

**3B SMART ANATOMY**

**Sam on Pelvic Mounted Roller Stand**

176.5 cm; 10 kg

**M-1020176**

**3B SMART ANATOMY**

**Sam on Hanging Stand (Hanging Stand shown on page 181)**

192.5 cm; 10 kg

**M-1020177**



## Demonstrate natural movement and realistic joint mechanisms with Phil

### Phil the Physiological Skeleton with Realistic Joint Mechanisms

Phil is unique in his near life-like realization of the joint mechanisms. He allows you to demonstrate the inward and outward rotation of the arms and legs and the extension and flexion of the knee and elbow joints. The flexible spine allows for natural movement (lateral inclination, movement and extension, rotation). The bones of the hands are wire mounted to demonstrate their natural positions. The foot bones are mounted flexibly to enable movability. The shoulder blades rotate along when the arms are raised. Even the restricted mobility of the iliosacral joint and the sacrococcygeal joint can be demonstrated.

### › PHIL MOVES!

**This skeleton has all the features of the Standard Classic Skeleton Model Stan, plus:**

- The flexible spine allows for natural movement
- Near life-like realization of the joint mechanisms
- Includes 3B SMART ANATOMY

### 3B SMART ANATOMY

#### Phil on Hanging Stand

192.5 cm; 9.6 kg

M-1020179



## Demonstrate movement and fix any posture for detailed explanations with Fred

### Fred the Flexible Skeleton with Extremely Bendable Spine

Fred's spine can be bent to mimic any natural human movement. Once flexed, it remains fixed in position to demonstrate correct and incorrect posture or various pathological conditions. In addition, all skull movements can be demonstrated. Spinal nerve exits and vertebral arteries are shown as well as a dorso-lateral disc prolapse between the 3<sup>rd</sup> and 4<sup>th</sup> lumbar vertebrae. Fred has all the standard benefits of a 3B Scientific Skeleton.

### 3B SMART ANATOMY

#### Fred on Pelvic Mounted Roller Stand

176.5 cm; 9,6 kg

M-1020178





## Demonstrate life-like movement unseen in any other skeleton model with Frank

### Frank the Functional Skeleton for Life-like Movement

This unique functional Skeleton comes on a hanging stand and features a flexible assembly of all joints, allowing you to perform the individual movements in a nearly life-like way. You can even demonstrate the complex motions of the upper extremity. The shoulder blades rotate along when the arms are raised. Graphically demonstrate the position of the radial and ulnar bones during inward and outward rotation of the lower arm. The flexible spine allows for natural movement (lateral inclination, flexion and extension, rotation). Even the restricted mobility of the iliosacral joint and the sacrococcygeal joint can be demonstrated.

### ➤ FRANK'S MOVES ARE TRULY UNIQUE!

**This skeleton contains all the features of the Standard Classic Skeleton Stan, plus:**

- The flexible assembly of all joints lets you perform life-like movement
- Complex motions of upper extremities can be demonstrated
- Includes 3B SMART ANATOMY

#### 3B SMART ANATOMY

#### Frank on Hanging Stand

192.5 cm; 9.6 kg

M-1020180

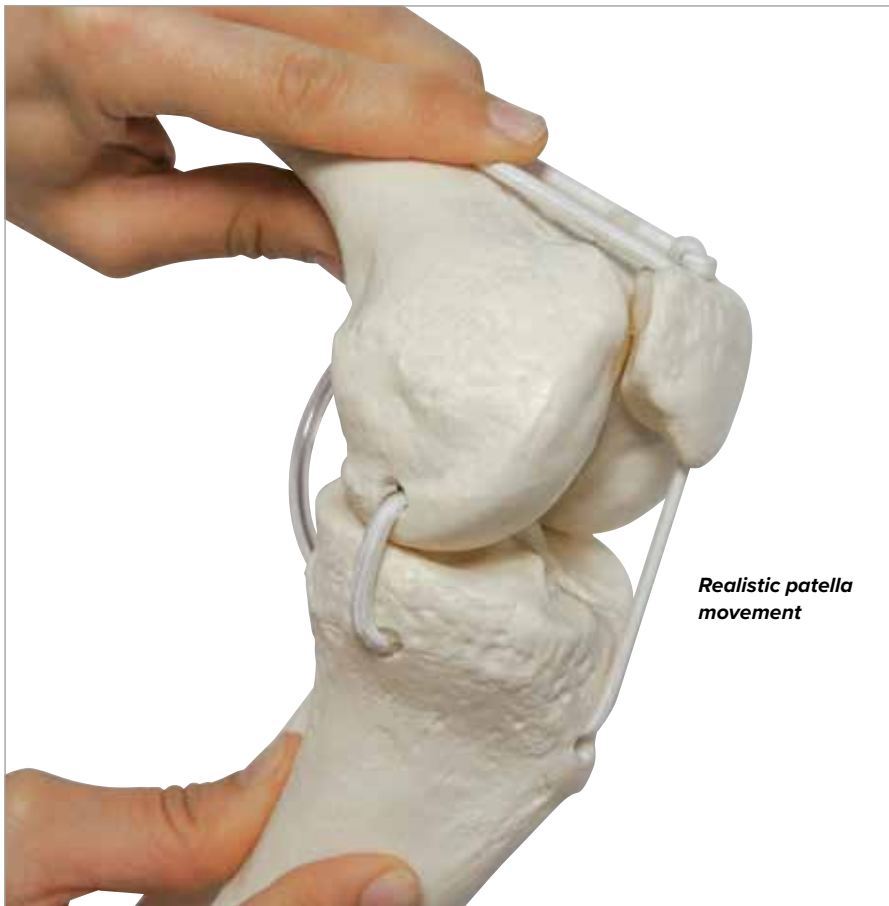

*Realistic patella movement*

## ➤ DISASSEMBLED SKELETON MODELS FOR DETAILED STUDY OF INDIVIDUAL BONES



### 3B SMART ANATOMY Disarticulated Full Skeleton, Numbered with Muscle Origins and Insertions

This disarticulated 3B Scientific® Skeleton is hand-painted and numbered to show muscle origins in red and muscle insertions in blue on the left side. The disarticulated skeleton's bones and bony structures such as fissures, foramina and processes are hand-numbered on the right side. The skull is detachable into 3 parts for detailed anatomical study. Consists of 179 pieces.

- Both hands and feet are wire mounted
- Vertebral column strung on thin, nylon wire
- Multilingual product manual to identify over 600 numbered anatomical structures
- Supplied in a sturdy partitioned cardboard storage box
- Includes 3B SMART ANATOMY

48.5 x 27 x 42.5 cm; 6 kg

**M-1020158**



### 3B SMART ANATOMY Disarticulated Full Skeleton, Wire Mounted Hand/Foot

One hand and foot on wire, the others loosely articulated. Supplied in a sturdy partitioned storage box.

48.5 x 27 x 42.5 cm; 4.8 kg

**M-1020157**



This high quality skeleton replica is great for any in-depth study of the human skeleton and scientific anatomy studies.



### 3B SMART ANATOMY Disarticulated Half Skeleton, with loose Hand/Foot

Complete with 3-part skull, sternum, hyoid and spinal column.

48.5 x 27 x 42.5 cm; 4 kg

**M-1020156**



### 3B SMART ANATOMY Disarticulated Half Skeleton, with Wire Mounted Hand/Foot

Complete with 3-part skull, sternum, hyoid and spinal column.

49 x 43 x 26.5 cm; 4 kg

**M-1020155**



## › SPACE SAVING MINIATURE SKELETON MODELS

### Shorty the Mini Skeleton

- Top of the range miniature human skeleton models
- 3-part removable skull (skullcap, base of skull, mandible)
- Removable arms and legs
- Specially mounted hip joints to demonstrate natural rotation of the hips
- Made from durable, unbreakable plastic, hand assembled
- Can be taken off of the base when required
- Includes 3B SMART ANATOMY

#### 3B SMART ANATOMY

##### A. Shorty the Mini Skeleton, Pelvic Mounted

88 cm, 1.5 kg

**M-1000039**

#### 3B SMART ANATOMY

##### Shorty the Mini Skeleton, Hanging Stand (not shown)

On hanging stand that can be placed on the floor or hung on the wall. 94 cm; 1.5 kg

**M-1000040**

#### 3B SMART ANATOMY

##### B. Shorty with Painted Muscles, Pelvic Mounted

Muscle origins (red) and insertions (blue) on the left half.

88 cm; 1.7 kg

**M-1000044**

#### 3B SMART ANATOMY

##### Shorty with Painted Muscles, Hanging Stand (not shown)

On hanging stand that can be placed on the floor or hung on the wall. 94 cm; 1.7 kg

**M-1000045**

*Mini Skeletons: Incredible detail and fully articulating joints!*

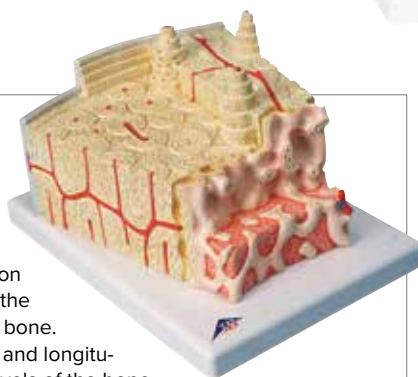
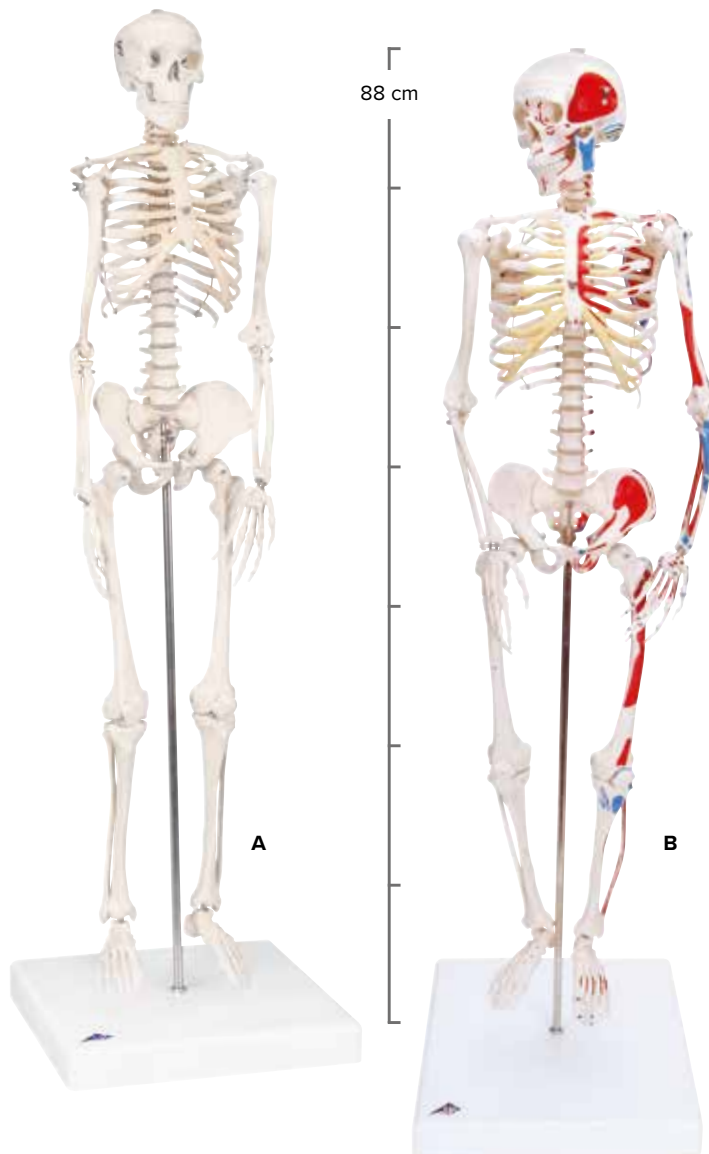

#### 3B SMART ANATOMY

##### MICROanatomy™

##### Bone Structure Model, enlarged 80 times

This model depicts a section of lamellar bone, showing the typical structure of tubular bone. Planes are shown in cross and longitudinal section through all levels of the bone and bone marrow. Typical elements are easily identified and help in understanding the structure and function of the Haversian systems. This representation graphically illustrates the individual bone components including spongy and compact substance, endosteum, cortical substance, osteocytes, Volkmann and Haversian canals.

26 x 19 x 14.5 cm; 0.8 kg

**M-1000154**

#### 3B SMART ANATOMY

##### Cancellous Bone

The model shows the spongy bone inside the bone. Its filigree architecture is determined by influences such as pressure, bending and torsion. Using innovative micro CT technology, we have managed to reconstruct an exact 3-dimensional copy of a piece of cancellous bone from an original and enlarge it 100 times.

17 x 17 x 23 cm; 0.29 kg

**M-1009698**



# INDIVIDUAL BONE MODELS



SCAN THE QR CODE ON P. 174 FOR A FREE  
3B SMART ANATOMY DEMO VERSION



## Benefits of flexibly mounted bone models:

The flexible bungee mounting enables the individual bones to be pulled back into their natural positioning after having been pulled apart for close up studies. The entire model will remain in its natural anatomical positioning when not pulled apart.



**3B SMART ANATOMY**  
**Loose Hand Skeleton with Ulna and Radius\***  
Loosely mounted on bungee string, ulna and radius wire mounted.  
**M-1019369**



**3B SMART ANATOMY**  
**Loose Foot and Ankle Skeleton**  
This loose foot and ankle skeleton comes mounted with elastic bungy for a flexible effect. The foot skeleton includes portions of the tibia and fibula with incredible detail cast from a real specimen.  
**M-1019358**



### Benefits of nylon mounted bone models:

The individual bones hold together in their anatomically correct location, but are loosely enough mounted for individual studies.



**3B SMART ANATOMY**  
**Loose Hand Skeleton**  
**(nylon mounted)\***  
**M-1019368**



**3B SMART ANATOMY**  
**Loose Foot Skeleton**  
**(nylon mounted)\***  
**M-1019356**

\*Unfortunately it is not possible to specify left or right version, you will randomly receive a left or right sided model. However this may be possible for large quantities, please call us for further details.



**Benefits of wire mounted bone models:**

Once flexed, the joints stay in the position you choose for demonstration purposes. The individual bones will always remain in a natural anatomical position.



**3B SMART ANATOMY  
Hand Skeleton  
with Ulna and Radius\*  
M-1019370**



**3B SMART ANATOMY  
Hand Skeleton  
(wire mounted)\*  
M-1019367**



**3B SMART ANATOMY  
Arm Skeleton\*  
M-1019371**



**3B SMART ANATOMY  
Arm Skeleton with  
Scapula and Clavicle\*  
M-1019377**



**3B SMART ANATOMY  
Leg Skeleton\*  
M-1019359**



**3B SMART ANATOMY  
Leg Skeleton with  
Hip Bone\*  
M-1019366**



**3B SMART ANATOMY  
Foot Skeleton  
(wire mounted)\*  
M-1019355**



**3B SMART ANATOMY  
Foot Skeleton  
with Tibia and Fibula  
(wire mounted)\*  
M-1019357**



\*Unfortunately it is not possible to specify left or right version, you will randomly receive a left or right sided model. However this may be possible for large quantities, please call us for further details.



**3B SMART ANATOMY**

**A. Ulna\***

**M-1019373**

**3B SMART ANATOMY**

**B. Radius\***

**M-1019374**

**3B SMART ANATOMY**

**C. Humerus\***

**M-1019372**

**3B SMART ANATOMY**

**D. Fibula\***

**M-1019364**

**3B SMART ANATOMY**

**E. Femur\***

**M-1019360**

**3B SMART ANATOMY**

**F. Tibia\***

**M-1019363**

**3B SMART ANATOMY**

**G. Hip Bone\***

**M-1019365**

**3B SMART ANATOMY**

**H. Patella\***

**M-1019362**

**3B SMART ANATOMY**

**I. Atlas and Axis, wire mounted**

**M-1000140**

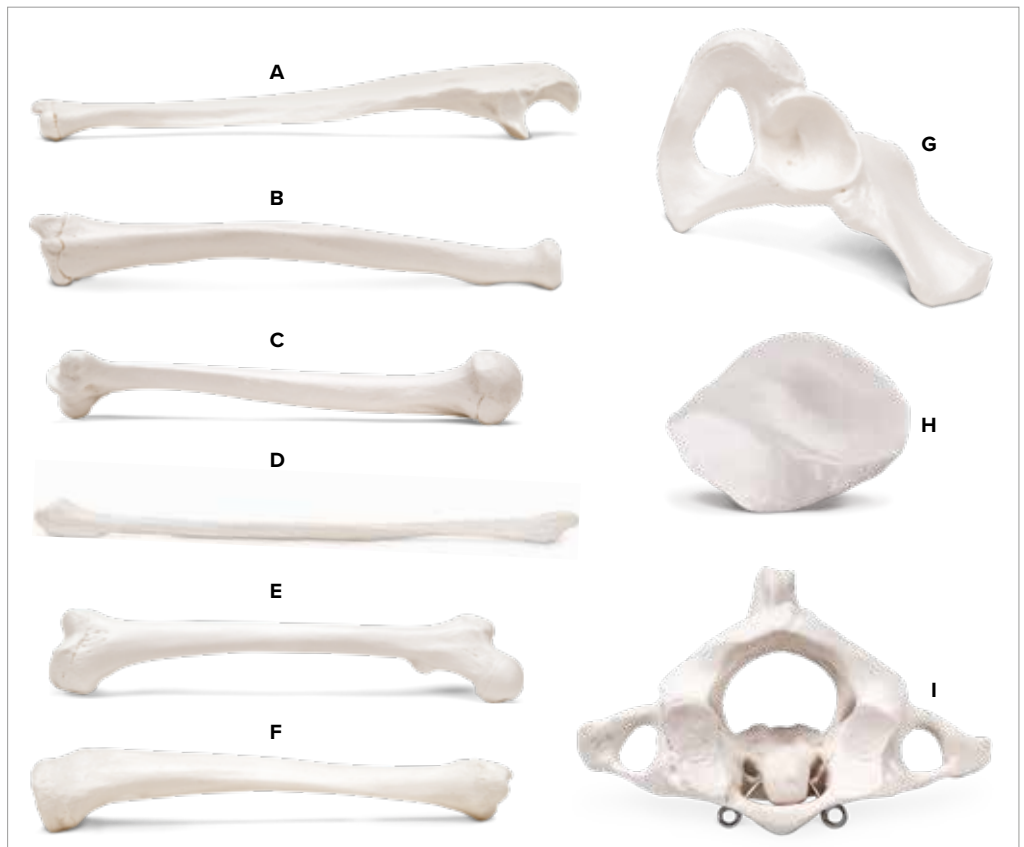

**3B SMART ANATOMY**

**J. Atlas and Axis, with occipital plate**

Elastically mounted together on removable stand.

**M-1000142**

**3B SMART ANATOMY**

**K. Hyoid Bone**

Mounted on stand.

**M-1000143**

**3B SMART ANATOMY**

**L. Sternum with Rib Cartilage**

Replica human sternum with rib cartilage.

**M-1000136**

**3B SMART ANATOMY**

**M. Clavicle\***

**M-1019376**

**3B SMART ANATOMY**

**N. Scapula\***

**M-1019375**

**3B SMART ANATOMY**

**O. Ribs\***

12 individual ribs of one side, unmounted.

**M-1000137**

**3B SMART ANATOMY**

**P. Sacrum and Coccyx**

Assembled

**M-1000139**

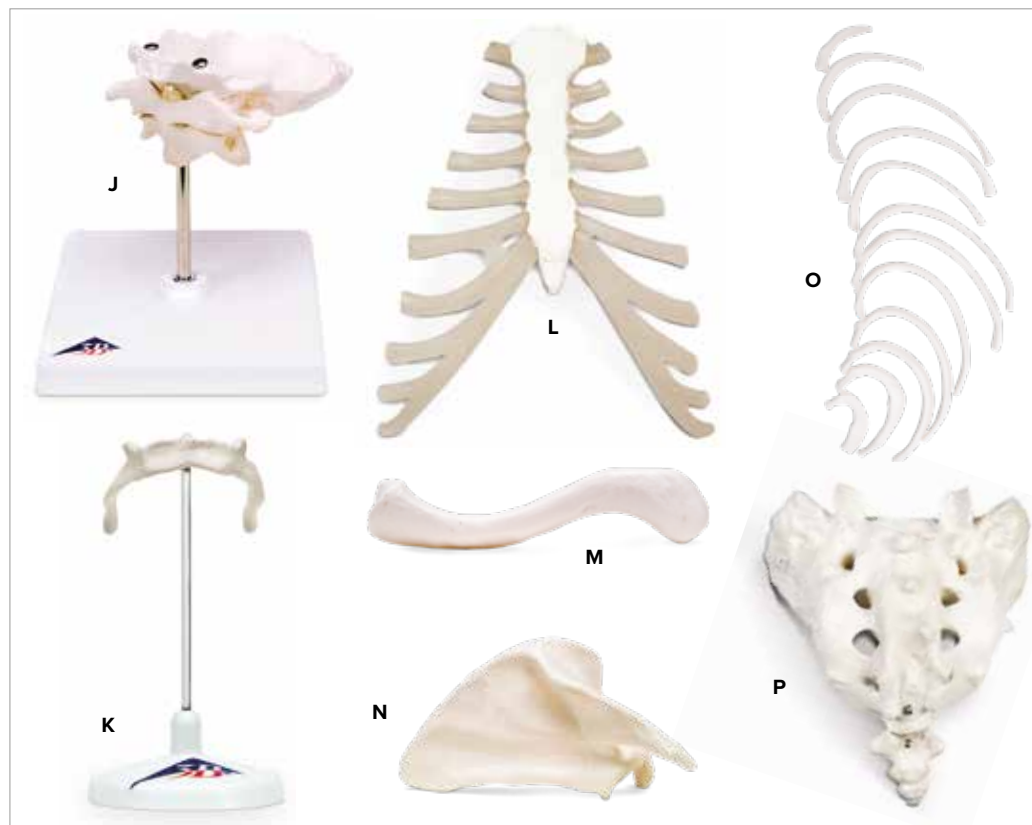

# HAND & FOOT MODELS



SCAN THE QR CODE ON P. 174 FOR A FREE  
3B SMART ANATOMY DEMO VERSION



**3 levels of  
amazing detail!**

## 3B SMART ANATOMY

### Structural Anatomy of the Hand, 3-part

Right down to the fingerprints, this full-size model shows amazing detail. The superficial and internal structures of the hand including bones, muscles, tendons, ligaments, nerves, veins, and arteries (superficial and deep palmar arches) are all present. The palmar aponeurosis and plate of the superficial flexor tendons are removable.

**Analyze the palmar surface through three increasingly deeper levels:**

- 1<sup>st</sup> level: palmar aponeurosis
- 2<sup>nd</sup> level: exposes the flexor retinaculum, superficial palmar arch, tendons of the flexor digitorum, and lumbricales muscles
- 3<sup>rd</sup> level: uncovers the deep palmar arch, and deep layer of muscles, nerves, tendons, and ligaments

28.5 x 13 x 6.5 cm; 1.2 kg

**M-1000349**



## 3B SMART ANATOMY

### Hand Skeleton Model with Ligaments and Muscles, 4-part

This high quality anatomically correct hand model with ligaments and muscles is great for detailed study of the hand and lower forearm.

**All bones, muscles, tendons, ligaments, nerves, arteries, and veins are featured:**

- Dorsal side: extensor muscles and portions of the tendons at the wrist passing under the extensor retinaculum
- Palmar face is represented in three layers, removable for detailed study of the deeper anatomical layer (median nerve, superficial palmar arch)
- Deepest anatomical layer shows the intrinsic muscles and deep palmar arterial arch

33 x 12 x 12 cm; 0.4 kg

**M-1000358**





### 3B SMART ANATOMY

#### Hand Skeleton Model with Elastic Ligaments

This single-part model shows the anatomy of the ligaments in the hand in detail. The elastic ligaments allow for the demonstration of the flexibility of wrist and fingers. The carpals (ossa carpi), the metacarpals (ossa metacarpi) and finger bones (ossa digitorum manus) are shown as osseous structures. In the distal area of the forearm, the radius and the ulna are represented.

14 x 10 x 28 cm; 0.24 kg

**M-1013683**



### 3B SMART ANATOMY

#### Hand Skeleton Model with Ligaments and Carpal Tunnel, 3-part

This 3-part hand skeleton model shows the anatomical detail of the ligaments and tendons found in the hand, wrist, and lower forearm. The interosseous membrane between the radius and ulna is shown along with the bones of the hand.

#### Removable parts:

- Palmar side of the hand: flexor retinaculum
- Structures of the carpal tunnel: flexor retinaculum, median nerve and tendons

30 x 14 x 10 cm; 0.3 kg

**M-1000357**



### 3B SMART ANATOMY

#### Internal Finger Structure Model

This full-size model shows the bones, muscles and tendons of the human index finger. Delivered on wire support stand.

19.5 x 13 x 19 cm; 0.5 kg

**M-1000350**



## 3 LAYERS REVEAL THE INTERNAL ANATOMY OF THE FOOT!

### ➤ REMOVABLE LIGAMENTS AND MUSCLES

#### 3B SMART ANATOMY

##### Foot Skeleton Model with Ligaments and Muscles, 6-part

This anatomically detailed model of the foot and lower leg can be disassembled into 6 parts for detailed study of the following structures: bones, muscles, tendons, ligaments, nerves, arteries, and veins. The frontal view of the foot model features the extensor muscles of the lower leg. The tendons can be followed on their passage under the transverse and crucial crural ligaments all the way to their insertion points. In addition all tendon sheaths of the foot area are visible. On the dorsal portion of the foot the gastrocnemius muscle is removable to reveal deeper anatomical elements.

##### **The sole of the foot is represented in three layers:**

- The first removable layer displays the flexor digitorum brevis
- The second removable layer consists of the quadratus plantae, the tendon of the flexor digitorum longus, and the flexor hallucis muscle
- The third layer reveals even deeper anatomical details of the foot

23 x 26 x 19 cm; 1.1 kg

**M-1019421**

#### 3B SMART ANATOMY

##### Foot Skeleton Model with Ligaments

High quality anatomical replica of the human foot and ankle, showing all important ligaments and tendons including the Achilles and peroneus longus tendons of the ankle. The foot skeleton consists of the foot bone and lower portions of the tibia and fibula, including the intraosseous membrane found between them.

23 x 18 x 30 cm; 0.6 kg

**M-1000359**

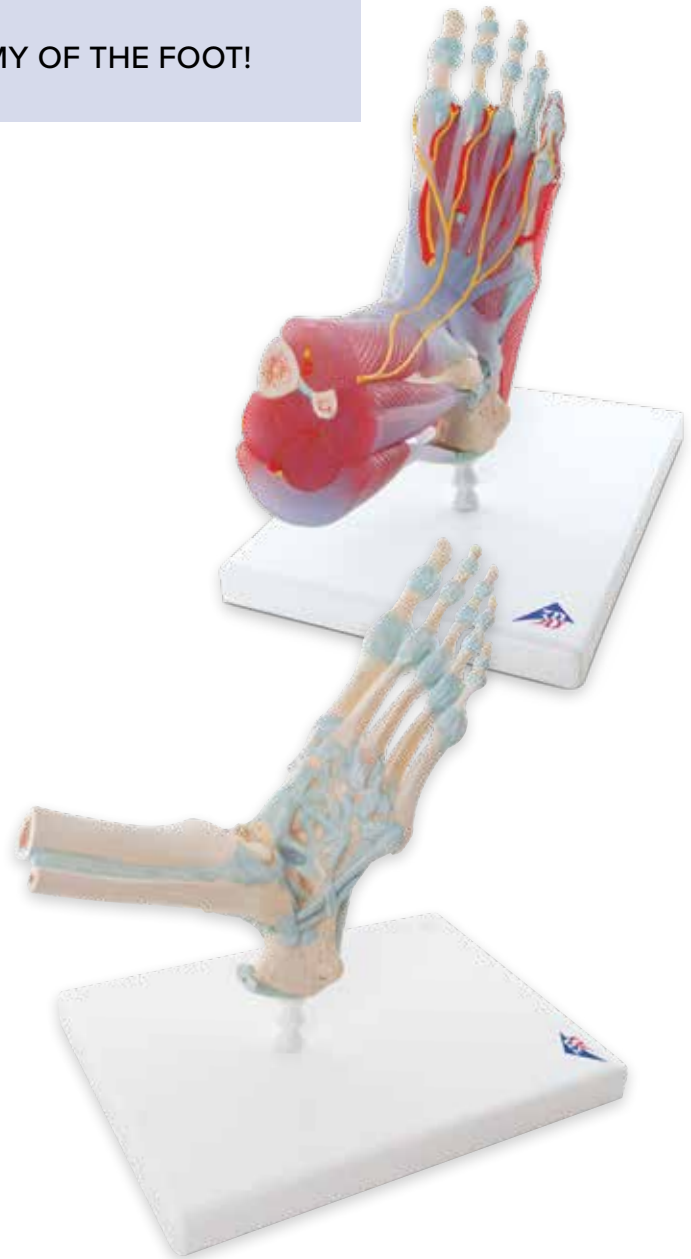

##### Foot/Ankle - Plantar Fasciitis Model

The model is a full size solid cast of ankle and foot bones features the plantar calcaneonavicular (spring) ligament with plantar fasciitis. Foot/ankle anatomy also includes: tibia, fibula, calcaneus, calcaneal (Achilles) tendon, deltoid ligament, lateral (collateral) ligament, plantar aponeurosis, cuneiform, phalanges, cuboid, navicular, and metatarsal bones.

22.9 x 7 x 10.2 cm

**M-1019522**

➤ TOOLS FOR PATIENT EDUCATION



**Single Foot Models**

Superficial structures, as well as internal bones, muscles, ligaments and nerves of the human foot are shown in these high quality models.

**3B SMART ANATOMY**

**A. Hollow Foot (Pes Cavus)**

13 x 23 x 10 cm; 0.5 kg

**M-1000356**

**3B SMART ANATOMY**

**B. Normal Foot (Pes Normal)**

13 x 24 x 9 cm; 0.4 kg

**M-1000354**

**3B SMART ANATOMY**

**C. Flat Foot (Pes Planus)**

12 x 24 x 10 cm; 0.4 kg

**M-1000355**

➤ ADD A CHART AS A CONSTANT VISUAL EDUCATION TOOL!

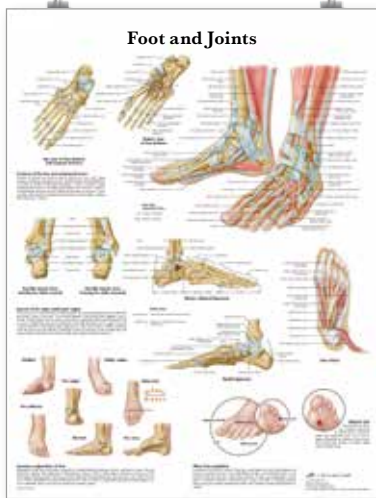

**Foot and Joints Anatomy Poster**  
Laminated. 50 x 67 cm  
**M-1001490**



**Hand and Wrist Anatomy Poster**  
Laminated. 50 x 67 cm  
**M-1001484**

**YOU MIGHT ALSO BE INTERESTED IN THE DIABETIC FOOT MODELS ON PAGE 295!**

# JOINT MODELS



SCAN THE QR CODE ON P. 174 FOR A FREE  
3B SMART ANATOMY DEMO VERSION



## Removable muscles for advanced anatomical studies:

- + Muscles can be taken off to study origins and insertions
- + All muscles can be studied individually
- + Muscle positioning can be trained
- + Highly realistic coloring of bone and muscles
- + Muscular origins and insertions are raised and color-coded
- + Removable parts for the study of the deeper anatomy
- + High quality, non-hazardous material for long lasting models

### 3B SMART ANATOMY Knee Joint

The 12 parts can quickly be removed for easy demonstrations both in medical training and patient education. The muscles and muscle portions can be taken off for detailed study of the deeper anatomical layers. Color-coded and raised areas indicate the muscle origin and insertion points on the femur, tibia, and fibula. Additionally, the model shows parts of the fibular and tibial collateral ligaments.

33 x 17 x 17 cm; 0.9 kg

**M-1000178**

**11 removable parts**



**Realistic details!**

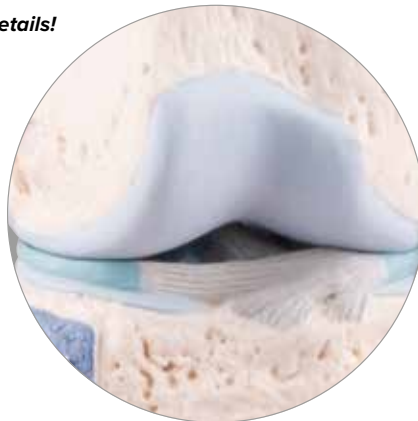



**3B SMART ANATOMY**  
**Elbow Joint**  
**with Removable Muscles, 8-part**

Right elbow of a male with individual muscles plus muscular origins and insertions on the humerus, radius, and ulna. The muscles can easily be attached to and removed from the corresponding areas of origin and insertion.  
 25 x 41 x 25 cm; 1.74 kg  
**M-1000179**



**3B SMART ANATOMY**  
**Shoulder Joint with Rotator Cuff, 5-part**

This model comprises the upper half of the humerus, the clavicle and the shoulder blade. The muscles of the rotator cuff (subscapularis muscle, supraspinatus muscle, infraspinatus muscle, teres minor muscle) are displayed. By removing the four individual muscles, all movements of the shoulder joint can be performed.

- Abduction
  - Inward rotation
  - Adduction
  - Outward rotation
- 18 x 18 x 24 cm; 0.85 kg  
**M-1000176**

**3B SMART ANATOMY**  
**Hip Joint with Removable Muscles, 7-part**

The model shows the right hip joint of an adult male with the individual muscles as well as the muscle origins and insertions on the femur and the hip bone. The hip muscles have been mounted on their corresponding regions of origin and insertion and are removable. The relationship of the muscular system and skeletal system are represented clearly with this human hip joint model.  
 18 x 32 x 18 cm; 1.9 kg  
**M-1000177**

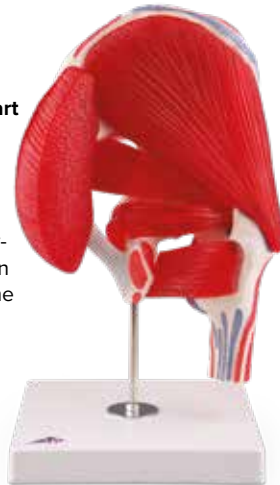

**Mini Muscled Joint Set**

Set of four, reduced size (approximately 50% of stock models), joint models of the hip, elbow, shoulder and knee (does not contain the structures of the hand and wrist).  
**M-1019518**

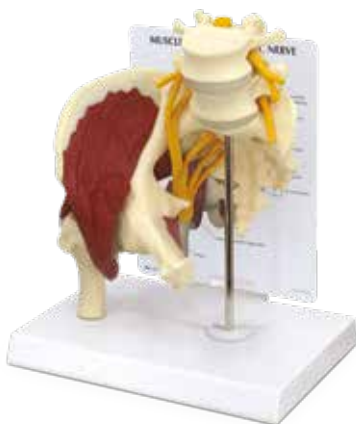

**Muscled Hip with Sciatic Nerve**

Full size normal right hip with proximal femur and lower lumbar vertebrae including: sciatic nerve, gluteus medius, gluteus minimus, iliacus, inferior and superior gemellus, obturator internus, piriformis and psoas muscles, articular capsule ligaments, L4-L5 with sacrum.  
 18.4 x 12.1 x 25.4 cm  
**M-1019505**



**TMJ Model**

Temporomandibular Joint (TMJ) model, demonstrating the problematic conditions associated with the joint capsule. Emphasis on the disc, surrounding bone inflammation, and also the effects on the teeth, (cracks, chips, cavities, and characteristics of bruxism).  
 15.2 x 15.2 x 16.5 cm  
**M-1019541**

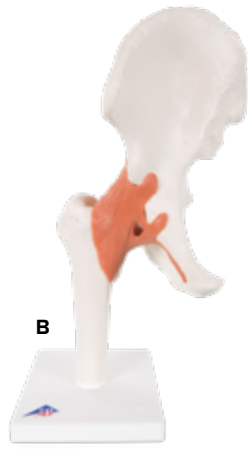
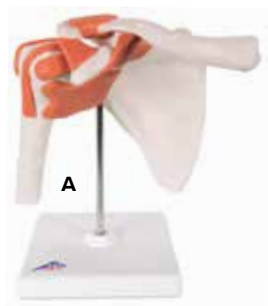

## ► DEMONSTRATE MOVEMENT

### Classic Flexible Joint Models

The classic series of high quality, life-size, functional joint models features the same look and size as the deluxe models but without the natural bone coloring process and the blue paint representing cartilage.

**3B SMART ANATOMY**  
**A. Flexible Shoulder**  
 16 x 12 x 20 cm  
**M-1000159**

**3B SMART ANATOMY**  
**B. Flexible Hip**  
 17 x 12 x 33 cm  
**M-1000161**

**3B SMART ANATOMY**  
**C. Flexible Knee**  
 12 x 12 x 34 cm  
**M-1000163**

**3B SMART ANATOMY**  
**D. Flexible Elbow**  
 12 x 12 x 39 cm  
**M-1000165**

## ► DEMONSTRATE MOVEMENT AND IMPACT ON CARTILAGE

### Deluxe Functional Joint Models

You can use these high-quality, functional joint models to demonstrate physiological movements. Thanks to the attached ligaments you can perform the following movements: abduction, anteversion, retroversion, internal and external rotation. The color of the natural-cast bones is extremely realistic thanks to a special coloring process. The cartilage on the joint surfaces is marked in blue. All deluxe functional joint models are mounted on a base for easy display.

**3B SMART ANATOMY**  
**E. Functional Shoulder**  
 22 cm; 0.41 kg  
**M-1000160**

**3B SMART ANATOMY**  
**F. Functional Hip**  
 32 cm; 0.56 kg  
**M-1000162**

**3B SMART ANATOMY**  
**G. Functional Knee**  
 32 cm; 0.55 kg  
**M-1000164**

**3B SMART ANATOMY**  
**H. Functional Elbow**  
 33 cm; 0.285 kg  
**M-1000166**

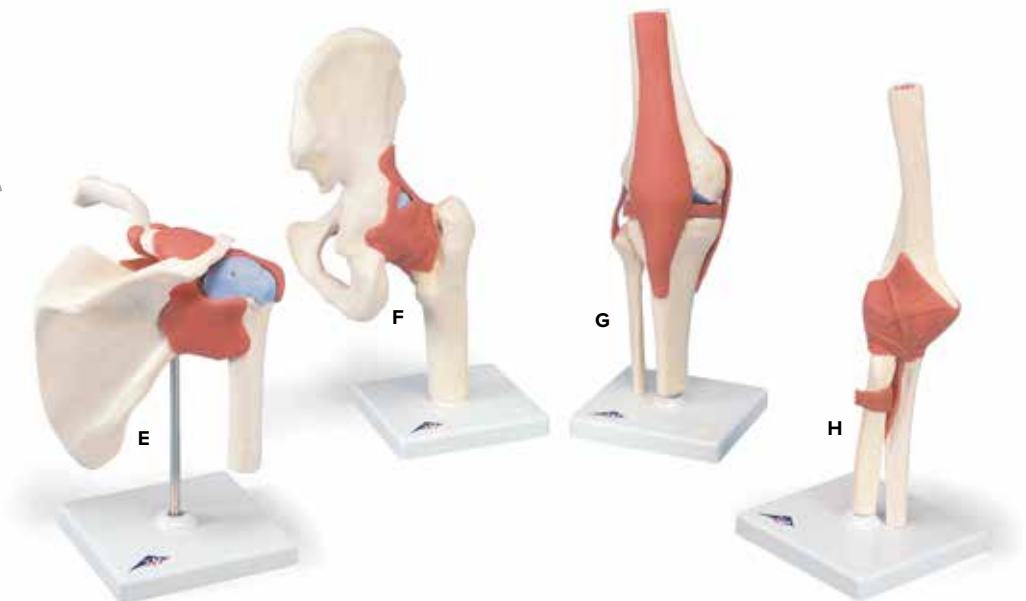
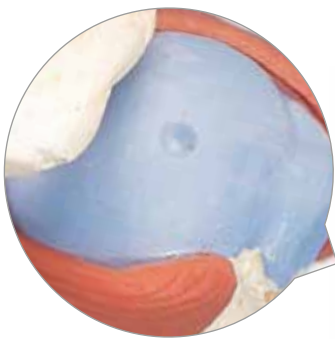



**Mini Joint Series with Cross-Section**

The mini joint series has been reduced to half the natural size while keeping all of the functionality. A joint cross-section has been added to the base to give an inside view.

**3B SMART ANATOMY**  
**I. Mini Shoulder**  
 12 x 14 x 16 cm  
**M-1000172**

**3B SMART ANATOMY**  
**J. Mini Hip**  
 16 x 12 x 20 cm  
**M-1000168**

**3B SMART ANATOMY**  
**K. Mini Knee**  
 10 x 14 x 24 cm  
**M-1000170**

**3B SMART ANATOMY**  
**L. Mini Elbow**  
 16 x 12 x 20 cm  
**M-1000174**

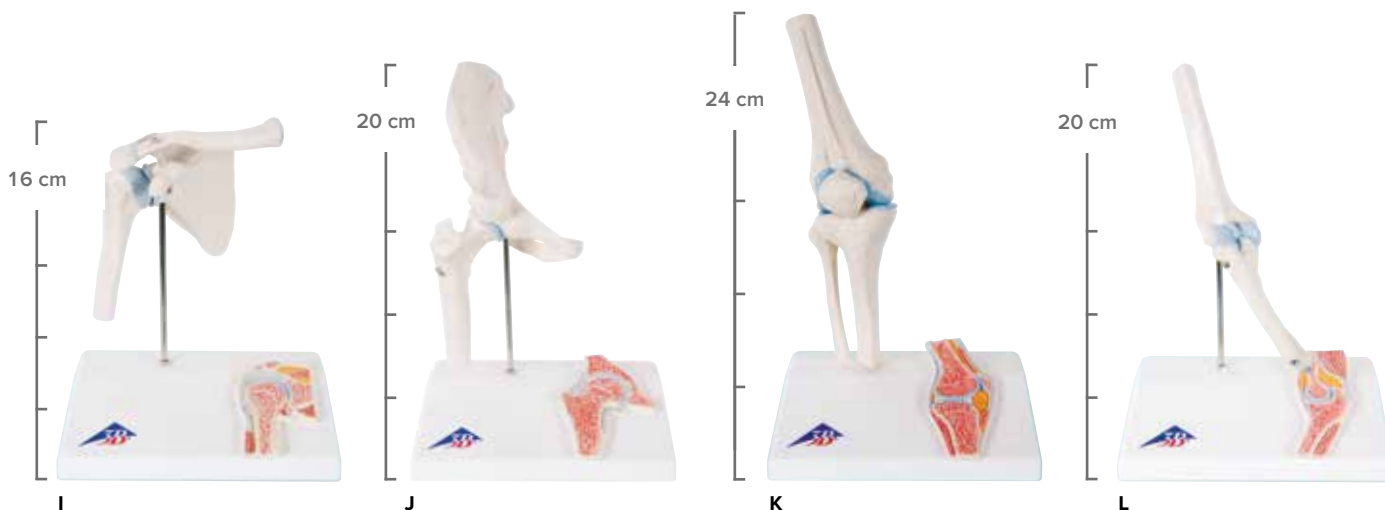

➤ **ENHANCE PATIENT EDUCATION WITH DETAILED PATHOLOGICAL MODELS**



**3B SMART ANATOMY**  
**Sectional Knee Joint Model, 3-part**  
 Demonstrate disorders of the knee joint with this full size model. Shows a healthy right knee joint with parts of femur, tibia and fibula, as well as the ligament system and the patella with parts of the femoral tendon. Can be disassembled to reveal internal structures. Mounted on base.  
 12 x 12 x 24 cm, 0.5 kg  
**M-1000180**



**Meniscus Knee Model with 6 Tears**  
 Full size normal right knee model demonstrating common meniscus tears. Condition shown includes: horizontal tear, flap tear, bucket handle, degenerative tear, radial tear, longitudinal tear.  
 16.5 x 6 x 15.2 cm  
**M-1019500**

**3B SMART ANATOMY**  
**Femoral Fracture and Hip Osteoarthritis**  
 At half natural-size, this model shows the right hip joint of an elderly person. Shown are the femoral fractures that occur most commonly as well as typical wear and tear and osteoarthritis of the hip joint. Additionally, a frontal section through the femoral neck is shown in relief on the base.  
 14 x 10 x 22 cm; 0.3 kg  
**M-1000175**



**4-Stage Osteo Knee Model Set**  
 Set of four knee models show the stages of the Osteoarthritic knee, reduced size, illustrating: degenerative joint disease (osteoarthritis); erosion to joint articular cartilage; progression of degenerative joint disease; osteophytes (bone spurs) at the articular surfaces. Advanced stage knee is articulating for additional view of joint.  
 7.6 x 4.44 x 14 cm  
**M-1019502**

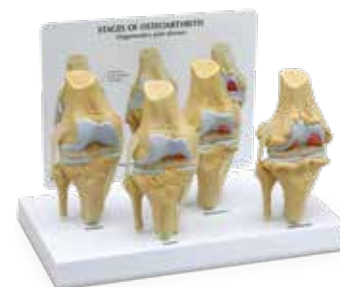

# VERTEBRAE MODELS



SCAN THE QR CODE ON P. 174 FOR A FREE  
3B SMART ANATOMY DEMO VERSION

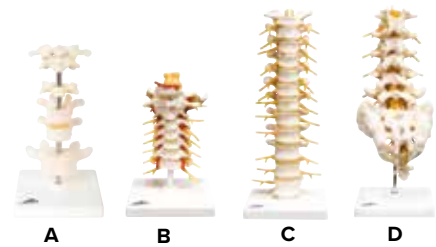

- 3B Scientific® vertebrae models are
- + Cast from real specimens
  - + Anatomically correct
  - + Highly detailed
  - + Made of extremely durable material

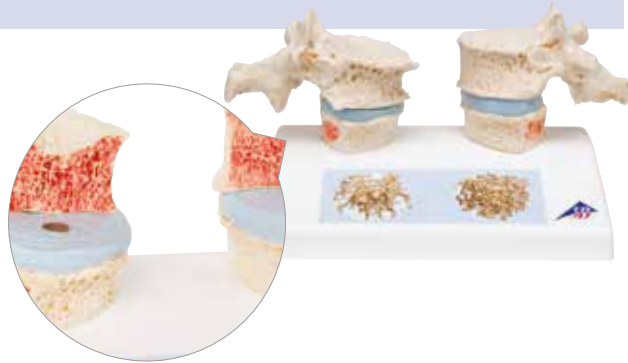

## ► DEMONSTRATE THE LOSS OF BONE MASS!

### 3B SMART ANATOMY

#### Magnetic Osteoporosis Model

Compare osteoporotic to normal thoracic vertebrae. Shows reproductions of osteoporotic 11<sup>th</sup> and 12<sup>th</sup> thoracic vertebrae with narrower intervertebral disc located on the left of the stand. Two corresponding healthy vertebrae with intervertebral disc are provided on the right side. The upper vertebra is divided in the middle and can easily be opened thanks to magnetic connections to show the cut surfaces to demonstrate sintering and osteophytes. A detailed illustration on the base depicts two 3D micro CT images obtained from biopsies of both a healthy and an osteoporotic bone.

14 x 9 x 10 cm; 0.2 kg

**M-1000182**

### 3B SMART ANATOMY

#### Osteoporosis Model (3 Vertebrae)

Consists of three medially divided lumbar vertebrae with intervertebral discs.

**Top:** healthy bone structure

**Middle:** osteoporotic bone structure

**Bottom:** advanced osteoporotic bone structure with flattened plates, deformation and decreased mass. For detailed study the vertebrae can easily be removed from the stand.

16 cm; 0.25 kg

**M-1000153**



### 3B SMART ANATOMY

#### A. 6 Mounted Vertebrae

Consists of atlas, axis, cervical vertebra, two thoracic vertebrae with intervertebral discs and one lumbar vertebra. On stand, removable.

22 cm; 0.46 kg

**M-1000147**

### 3B SMART ANATOMY

#### B. Cervical Section

Real life replica consisting of occipital plate, the 7 vertebrae with discs, cervical nerves, vertebral arteries and spinal cord. Flexibly mounted on stand.

19 cm; 0.3 kg

**M-1000144**

### 3B SMART ANATOMY

#### 5 Mounted Vertebrae (not shown)

Consisting of atlas, axis, cervical, thoracic and lumbar vertebra. Loosely threaded on nylon.

**M-1000148**

### 3B SMART ANATOMY

#### C. Thoracic Section

Consisting of the 12 thoracic vertebrae with discs, thoracic nerves and spinal cord. Flexibly mounted on stand.

32 cm; 0.5 kg

**M-1000145**

### 3B SMART ANATOMY

#### D. Lumbar Section

High quality model of the 5 lumbar vertebrae with discs, sacrum with flap, coccyx, spinal nerves and spinal cord. On removable stand.

34 cm; 0.6 kg

**M-1000146**

### 3B SMART ANATOMY

#### A. Lumbar Spinal Column with Prolapsed Intervertebral Disc

Natural casts of L4 and L5 lumbar vertebrae with paired spinal nerves, spinal cord and two interchangeable intervertebral discs. The discs illustrate either central or dorso-lateral prolapse. Dissects into 5 parts. On removable stand.

13 cm; 0.27 kg

**M-1000149**



**A**

### 3B SMART ANATOMY

#### B. 3 Lumbar Vertebrae

Flexibly mounted with spinal nerves and spinal cord.

11 cm; 0.15 kg

**M-1000151**



**B**

### 3B SMART ANATOMY

#### C. 2 Lumbar Vertebrae with Prolapsed Disc

With prolapsed disc. Flexibly mounted with spinal nerves and spinal cord.

9 x 11 x 9 cm; 0.15 kg

**M-1000152**



**C**



**3B SMART ANATOMY**

**5-Stages of Vertebral Degeneration**

The model illustrates degenerative changes to the vertebral bodies and intervertebral discs of the lumbar spine in various degrees. Based on the original cast of a human lumbar spine, even finest bone structures are accurately depicted. From top to bottom, the model shows the stages of degeneration starting with the healthy Lumbar vertebra (L1), stages of prolapsed discs, all the way to strong degenerative changes and bony constriction in L5. The model can be disassembled easily into vertebrae and intervertebral discs. Supplied on base.

22 cm; 0.5 kg  
**M-1000158**

**3B SMART ANATOMY**

**Prolapsed Lumbar Section**

The lumbar model includes a prolapsed intervertebral disc between the 3<sup>rd</sup> and 4<sup>th</sup> lumbar vertebrae.

On removable stand.  
 34 cm; 0.55 kg

**M-1000150**



**Deluxe Muscled Cervical Spine**

The Deluxe muscled Cervical Spine is a full size model features brain stem, occipital bone, atlas and axis through C7, with herniated disc, T1 and T3. This model has a soft cerebellum and full nerve with right side brachial plexus. Muscles include suboccipital triangle, longus capitis, levator scapulae, scalenus medius posterior and anterior. The right first and second ribs are also featured and include cartilage.

14 x 16.5 x 25.4 cm  
**M-1019511**



**4-Stage Vertebrae Model Set**

4-Stage Vertebrae Model Set of four, full size two-piece vertebrae models – one each of the following conditions: normal, “bulging” herniated disc, bone and disc degeneration, and advanced osteoporosis with marked bone compression and bone spurs.

8.9 x 7 x 7.6 cm  
**M-1019512**



**4-Stage Degenerative Lumbar Set**

These life-size models show 4 stages of lumbar degeneration of L4 and L5:

1. Normal disc and bone
  2. Facet Syndrome and a herniated disc
  3. Thinning disc and the beginning of bone spurring
  4. Seriously degenerated disc with bone fusing
- Mounted on wooden base.

8.5 cm; 0.5 kg  
**M-1005866**

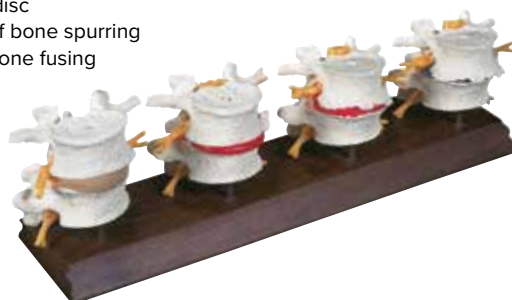

**Anatomical Lifting Manikin**

This functional figure provides a graphic demonstration of how the human spinal column reacts when heavy objects are lifted correctly and incorrectly. If the correct posture is used, the spine is undistorted. Incorrect posture exhibits obvious stress and distortion to the lumbar spine. Anatomical illustrations of the spine are featured on the base. Includes booklet with detailed information.

28 x 21 x 21.5 cm; 1.4 kg  
**M-1005101**

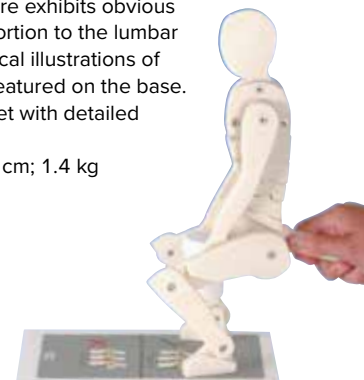

# 3B BONElike™



SCAN THE QR CODE ON P. 174 FOR A FREE  
3B SMART ANATOMY DEMO VERSION

+

## What is 3B BONElike™?

3B Scientific® BONElike™ material looks and feels like real bone. Each bone is a unique original cast of natural human bone with realistic weight, feel and appearance.

- + Represents even the finest anatomical structures with realistic texture, color, and the porous characteristics of real human bone
- + Makes an excellent alternative to real bone
- + Great for use in medical teaching settings and in patient education

An excellent way to study the detail of the anatomy of the human spine!



### 3B BONElike™ Vertebrae Sets

These realistic, high quality casts of original bones show even the finest anatomical structures in great detail. Supplied on a base.

30 x 21 x 6 cm; 0,2 kg

#### 3B SMART ANATOMY

##### A. 3B BONElike™ Cervical Vertebrae – Set of 7

M-1000021

#### 3B SMART ANATOMY

##### B. 3B BONElike™ Lumbar Vertebrae – Set of 5

M-1000155

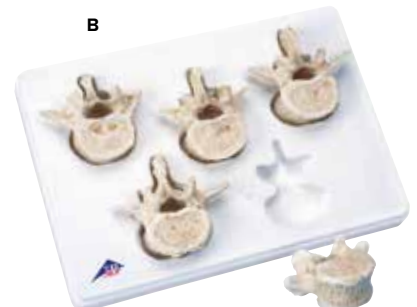

#### 3B SMART ANATOMY

##### Set of 24 3B BONElike™ Vertebrae Models

This set is a worldwide unique original anatomical replica of human vertebrae with the most precise illustration of even the finest anatomical structures, exhibiting excellent quality. The vertebrae set includes the 7 cervical, 12 thoracic and 5 lumbar vertebrae.

- Made of 3B BONElike™ material, feels and looks like real bones
  - Realistic weight
  - Excellent as a substitute for real bones for medical teaching purposes and patient consultation
  - Each vertebra is labeled for identification purposes
  - Supplied in transport and storage case with individual compartments for all 24 vertebrae
- 41 x 40 x 12 cm; 2,4 kg

M-1000156





### 3B SMART ANATOMY

#### 3B BONElike™ Vertebral Column Model

This anatomical replica of the human spine is a flexible, mounted, true-to-life model of the human vertebral column in excellent 3B BONElike™ quality. The spine is an original reproduction of all anatomical details with realistic weight. It consists of the male pelvis and occipital bone. Occipital bone and atlas can be detached individually from the spine for detailed study. Stand is sold separately, please see M-1000132 on page 204 to add to your order.

85 cm; 1.5 kg

**M-1000157**



➤ Excellent substitute for a real human spine!



### 3B SMART ANATOMY

#### 3B BONElike™ Child's Vertebral Column Model

This true-to-life anatomical replica of the vertebral column of a child around 5 years of age is especially interesting for those working in the areas of anatomy, paediatrics, orthopaedics and paediatric radiology. The unique material of the spine model makes it almost visually indistinguishable from a real vertebral column.

***It is particularly useful in studying the phases of bone growth:***

- Vertebrae – partially incomplete development of vertebral bodies and vertebral arches
- Sacrum – as yet incomplete fusion of individual sacral vertebrae. This commences at around the age of 15
- Pelvis – still open Y cartilage as main growth plate of the acetabulum. The hip, pubic and ischial bone parts are not yet connected (didactically fixed with brackets in the model). These fuse around the age of 14 – 16

**M-1000118**



# SPINAL COLUMN MODELS



SCAN THE QR CODE ON P. 174 FOR A FREE  
3B SMART ANATOMY DEMO VERSION

## CLASSIC SPINES

➤ Fully flexible spine models for hands-on demonstrations!

All models of the classic series are of the highest quality, made of an extremely durable material for everyday use. They are anatomically correct and precisely detailed, and show even the finest structures. Flexibly mounted for more realistic demonstrations.



### 3B SMART ANATOMY Classic Flexible Spine Model\*

Affordable spine model,  
extremely popular in  
medical education.  
Male pelvis.  
74 cm; 1.8 kg  
**M-1000121**

\*Stands sold separately. Please see page 204 for details.



### 3B SMART ANATOMY Classic Flexible Spine Model with Femur Heads\*

Same features as the  
Classic Flexible Spine,  
plus the femur heads.  
Male pelvis with femur  
heads.  
83 cm; 2.1 kg  
**M-1000122**

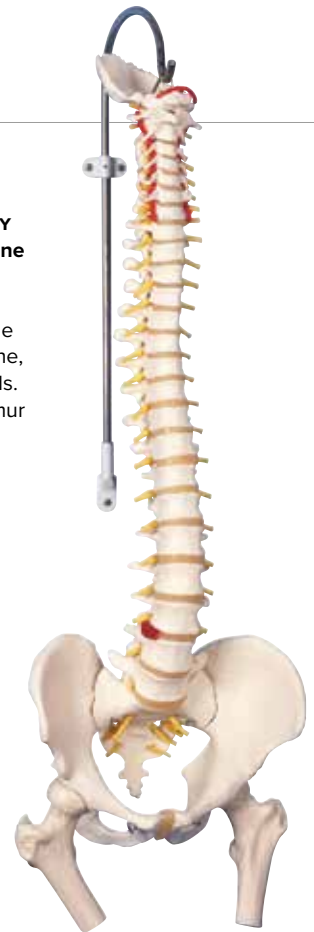

## DIDACTIC SPINES



Colored for simplified education – visible even from a distance in the classroom!

### Didactic Spine Model

*The 5 different sections of the spinal column are differentiated by color on these models:*

- 7 cervical vertebrae
- 12 thoracic vertebrae
- 5 lumbar vertebrae
- Sacrum
- Coccyx

Didactic colors help to easily follow explanation about the human spine, even from a distance. They are extremely durable models of high quality.

### Other great features of all spines in the Didactic Series include:

- Full pelvis and occipital plate
- Fully flexible mounting throughout spine
- L3-L4 disc prolapsed on spine
- Spinal nerve exits
- Cervical vertebral artery
- Didactic coloring
- Male pelvis



### 3B SMART ANATOMY Male Pelvis with Femur Heads\*

82 cm; 2.1 kg  
**M-1000129**

### 3B SMART ANATOMY Didactic Flexible Spine Model (not shown)\*

Male pelvis  
74 cm; 1.9 kg  
**M-1000128**





**3B SMART ANATOMY  
Classic Flexible Spine Model  
with Female Pelvis\***

This version comes with a female pelvis in addition to the features of the Classic Flexible Spine.  
74 cm; 1.8 kg  
**M-1000124**



**3B SMART ANATOMY  
Classic Flexible Spine Model with Femur Heads  
and Painted Muscles\***

Didactic benefit: muscle origins (red) and insertions (blue) are hand-painted on left innominate, femur and vertebrae. Otherwise same features as the Classic Flexible Spine.

- Male pelvis
- Painted muscle origins and insertions on left innominate femur and vertebrae

83 cm; 2.1 kg  
**M-1000123**

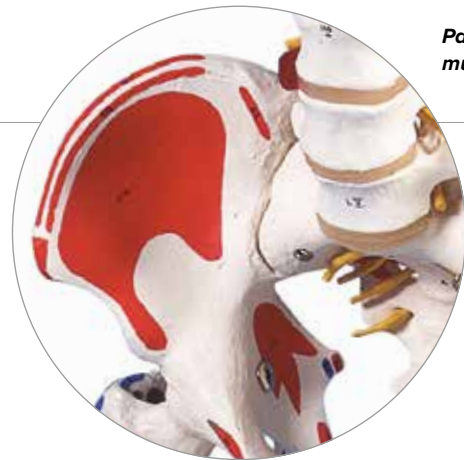

Painted  
muscle origins



**CLASSIC SPINE WITH RIBCAGE**



Demonstrate the connection and interaction of the spine with individual ribs!



**3B SMART ANATOMY  
Classic Flexible Spine Model with Ribs and Femur Heads\***

Flexible spine model with ribs show the interaction of individual ribs with the spine and associated structures.

***This model includes the following features:***

- Movable mounted femur heads
- Complete ribcage with individual mounted ribs
- Full pelvis and occipital plate
- Fully flexible mounting
- L3 -L4 disc prolapsed
- Spinal nerve exits
- Cervical vertebral artery

• Male pelvis  
83 cm; 3 kg  
**M-1000120**

*\*Stands sold separately. Please see page 204 for details.*

## HIGHLY FLEXIBLE SPINES



Special mounting with flexible core adds stability for active hands-on use!

The spine models in the Highly Flexible Series are specially mounted on a flexible core, adding extra stability. This makes them ideal for active, hands-on use and demonstrations of movement, great for medical and patient education. These spines are extremely durable.

**More features of spines in the Highly Flexible Series include:**

- Complete pelvis and occipital plate
- Full flexible mounting throughout spine with added core for more stability
- L3-L4 disc prolapsed on spinal column
- Spinal nerve exits
- Cervical vertebral artery
- Male pelvis



*Flexible discs for natural bending of the spine*



**3B SMART ANATOMY**  
**Highly Bendable Spine Model with Femur Heads\***  
 Male pelvis with femur heads  
 83 cm; 2.3 kg  
**M-1000131**

**3B SMART ANATOMY**  
**Highly Bendable Spine Model (not shown)\***  
 Male pelvis  
 74 cm; 1.4 kg  
**M-1000130**

**3B SMART ANATOMY**

**Highly Bendable Spine with Soft Intervertebral Discs**

This high quality spine model shows how the discs deform during normal and abnormal positioning. It is a valuable tool to demonstrate pathological conditions such as scoliosis, lordosis, kyphosis, or subluxations. Herniation of the vertebral column can also be demonstrated with compression. The model comes complete with spinal cord and spinal nerves. The special mounting allows a clear view during demonstration and display of the spine. Delivered on removable stand.

26 x 25 x 90 cm; 3 kg  
**M-1008545**



Complete comparison guide for all spine models on page 204. Choose the right model for your individual needs.



## ADVANCED SPINES



For advanced studies, includes a sacral opening and an exposed brain stem

In addition to all features of the Classic Series, the Deluxe Series has a sacral opening and exposed brain stem for advanced studies of the anatomy of the human spine.

**Other features of all spines in the Deluxe Series include:**

- Sacral opening and exposed brain stem
- Extremely durable material for everyday use
- Full pelvis and occipital plate
- Fully flexible mounting throughout spine
- L3-L4 disc prolapsed on spinal column
- Spinal nerve exits
- Cervical vertebral artery
- Male pelvis



**3B SMART ANATOMY**

**Deluxe Flexible Spine Model with Femur Heads\***

Male pelvis with femur heads

83 cm; 2.1 kg

**M-1000126**

**3B SMART ANATOMY**

**Deluxe Flexible Spine Model (not shown)\***

Male pelvis

74 cm; 1.8 kg

**M-1000125**



**3B SMART ANATOMY**

**Deluxe Flexible Spine Model with Femur Heads and Painted Muscles\***

- Male pelvis with femur heads
- Hand-painted muscle origins and insertions on left innominate, femur and vertebrae

83 cm; 2.1 kg

**M-1000127**

\* Stands sold separately.

Please see page 204 for details.



Item No.	Highly Bendable Spines			Classic Spines				Didactic Spines	
	M-1008545	M-1000130	M-1000131	M-1000123	M-1000124	M-1000121	M-1000122	M-1000128	M-1000129
Page	202	202	202	201	201	200	200	200	200
Top quality natural casts	✓	✓	✓	✓	✓	✓	✓	✓	✓
Assembled by hand	✓	✓	✓	✓	✓	✓	✓	✓	✓
Durable, unbreakable plastic	✓	✓	✓	✓	✓	✓	✓	✓	✓
Natural size	✓	✓	✓	✓	✓	✓	✓	✓	✓
Soft intervertebral discs	✓	✓	✓	✓	✓	✓	✓	✓	✓
L3-L4 prolapsed disc	-	✓	✓	✓	✓	✓	✓	✓	✓
Highly bendable	✓	✓	✓	-	-	-	-	-	-
Flexible	✓	✓	✓	✓	✓	✓	✓	✓	✓
Muscle insertions and origins, hand-painted	-	-	-	✓	-	-	-	-	-
Spinal nerves and vessels	✓	✓	✓	✓	✓	✓	✓	✓	✓
Realistic movement of the hip	-	-	✓	✓	-	-	✓	-	✓
Male pelvis	✓	✓	✓	✓	-	✓	✓	✓	✓
Female pelvis	-	-	-	-	✓	-	-	-	-
With Ribcage	-	-	-	-	-	-	-	-	-
With Femur Heads	-	-	✓	✓	-	-	✓	-	✓
3B BONElike™ Material	-	-	-	-	-	-	-	-	-
3B SMART ANATOMY	✓	✓	✓	✓	✓	✓	✓	✓	✓

## MINIATURE MODELS

- ▶ Anatomically correct and flexible at a fraction of the size.  
Perfect for your desk or as a gift!

### 3B SMART ANATOMY

#### Mini Human Spinal Column

The miniature model includes occipital plate of the skull, intervertebral discs, and pelvis. It is mounted flexibly to demonstrate natural movements and pathological changes.

Delivered without stand; 40 cm

**M-1000042**

### 3B SMART ANATOMY

#### Mini Human Spinal Column

Delivered with stand; 44 cm

**M-1000043**



### Multifunctional Stand for Spinal Columns, 3 part

The stand can be placed on the floor or desk, or mounted on a wall. Measures 86 cm tall on a 24 cm square base; 0.75 kg

**M-1000132**

Advanced Spines			Classic Spines with Ribcage	3B BONElike™ Spines		Miniature Spines	
M-1000126	M-1000127	M-1000125	M-1000120	M-1000118	M-1000157	M-1000042	M-1000043
203	203	203	201	199	199	204	204
✓	✓	✓	✓	✓	✓	✓	✓
✓	✓	✓	✓	✓	✓	✓	✓
✓	✓	✓	✓	✓	✓	✓	✓
✓	✓	✓	✓	✓	✓	-	-
✓	✓	✓	✓	✓	✓	✓	✓
✓	✓	✓	✓	-	-	-	-
-	-	-	-	-	-	-	-
✓	✓	✓	✓	-	✓	✓	✓
-	✓	-	-	-	-	-	-
✓	✓	✓	✓	-	-	✓	✓
✓	✓		✓	-	-	-	-
✓	✓	✓	✓	-	✓	✓	✓
-	-	-	-	-	-	-	-
-	-	-	✓	-	-	-	-
✓	✓	-	✓	-	-	-	-
-	-	-	-	✓	✓	-	-
✓	✓	✓	✓	✓	✓	✓	✓





**Spinal Column Poster**

The anatomy of the human spine is illustrated beautifully in this informative poster. The spinal column is depicted in detail and common pathologies are outlined, including osteoporosis, scoliosis, and disc herniation.

Laminated, 50 x 67 cm  
**M-1001480**

Please go online to [3bscientific.com](http://3bscientific.com) to browse the large selection of medical posters, or see pages 298-301.

➤ HIGHLY ROBUST

# PELVIS & PELVIC SKELETON MODELS



SCAN THE QR CODE ON P. 174 FOR A FREE  
3B SMART ANATOMY DEMO VERSION

+

## PELVIC SKELETON MODELS

- + Natural casts
- + Extremely detailed
- + Made of virtually unbreakable plastic



### 3B SMART ANATOMY Male Pelvic Skeleton

Consisting of hip bone, sacrum with coccyx and two lumbar vertebrae. 18 x 28 x 23 cm; 0.8 kg

**M-1000133**



### 3B SMART ANATOMY Female Pelvic Skeleton

Consisting of hip bone, sacrum with coccyx, and two lumbar vertebrae; including movable symphysis. 19 x 25 x 10 cm; 0.9 kg

**M-1000134**



### 3B SMART ANATOMY Female Pelvic Skeleton with Movable Femur Heads

This realistic pelvic skeleton model consists of hip bone, sacrum with coccyx and 2 lumbar vertebrae as well as movable symphysis.

30 x 30 x 20 cm; 1.2 kg

**M-1000135**

### 3B SMART ANATOMY

#### 3B Scientific's new "Bungee" pelvic bone models

are naturally cast from a female pelvis. All the pelvic bones are flexibly mounted and can be easily disassembled. Available with or without femur heads, these models perfectly demonstrate the articulation of the pelvic joints. Highly suitable for patient education as well as being a useful learning tool for midwives and in the areas of Obstetrics, Gynecology and Orthopedics.



### 3B SMART ANATOMY Flexible Female Pelvis with Femur Heads

**M-1019865**



### 3B SMART ANATOMY Flexible Female Pelvis

**M-1019864**

➤ IDEAL FOR THE CLASSROOM OR DOCTOR'S OFFICE!

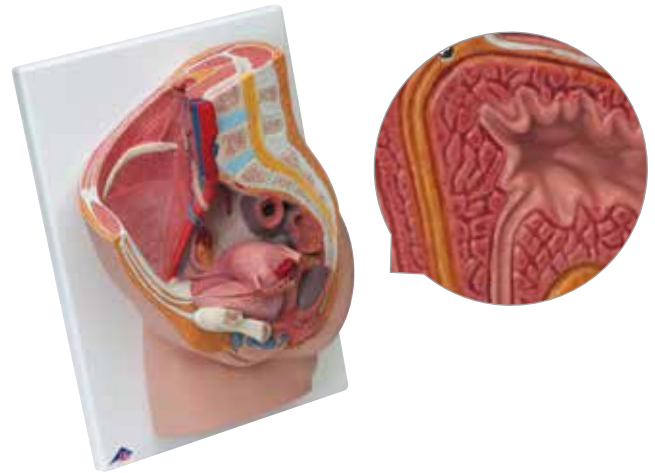
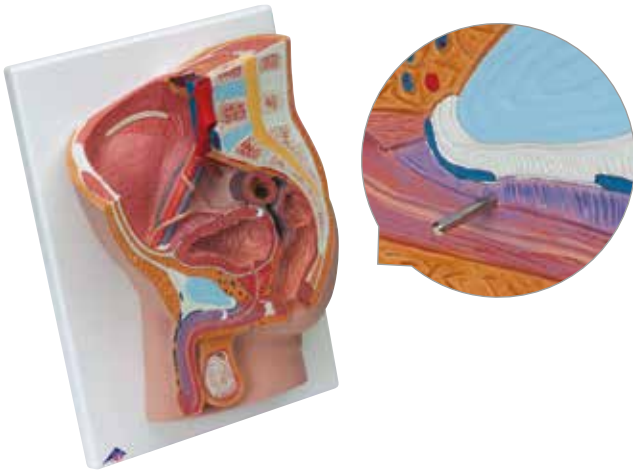

**3B SMART ANATOMY**  
**Life-Size Male Pelvis, 2-part**

The male pelvis anatomy model is shown in median section. One half of male genital organs with bladder, shown at the normal position in the male pelvis. The rectum is removable for a more detailed study of the male pelvic anatomy. Delivered on baseboard offering the possibility to be mounted to the wall.

41 x 31 x 17 cm; 2.5 kg

**M-1000282**



**3B SMART ANATOMY**  
**Life-Size Female Pelvis, 2-part**

This female pelvis is in median section. It shows one half of the female genital organs with bladder and removable rectum. The female pelvis is delivered on baseboard offering the possibility to be mounted to the wall for easy display.

41 x 31 x 20 cm; 2.2 kg

**M-1000281**

➤ MOLDED FROM DURABLE AND SOFT VINYL!



**3B SMART ANATOMY**  
**Female Pelvis Skeleton with Genital Organs, 3-part**

This model is especially suitable for studying the position of female genital organs in the pelvis. It consists of a natural cast female pelvis with a movable symphysis, hip bone, sacrum, coccyx, 4<sup>th</sup> and 5<sup>th</sup> lumbar vertebrae, and a female genital insert with rectum. The bladder and a portion of the uterus with one fallopian tube and ovary can be removed.

The soft tissues are molded from durable, soft vinyl.

Delivered on base.

33 x 26 x 18 cm; 2 kg

**M-1000335**



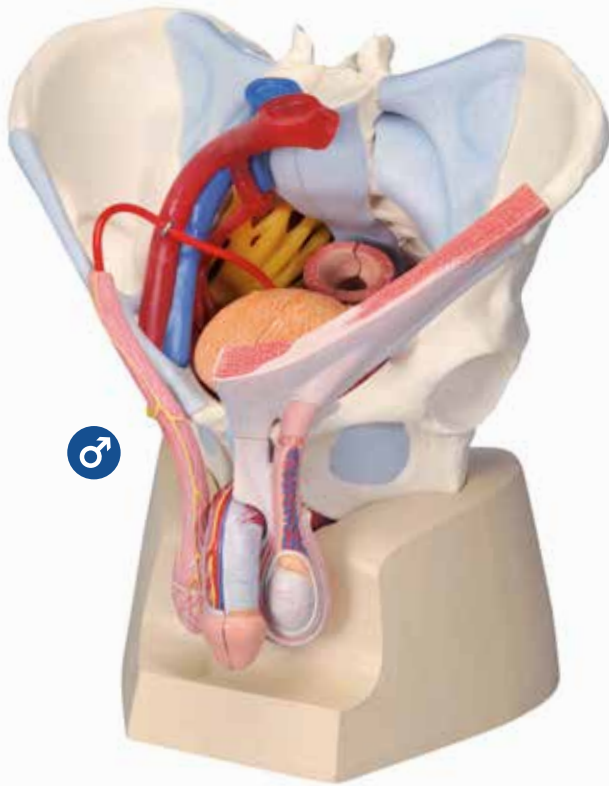

### 3B SMART ANATOMY

#### Male Pelvis with Ligaments, Vessels, Nerves, Pelvic Floor and Organs, 7-part

Extensive educational tool for a better understanding of the comprehensive anatomy of the male pelvis. For close up study, the pelvis splits into two halves and the following parts can be removed: Left half of the fifth lumbar vertebra, rectum, bladder, prostate and penis.

- Includes bones, ligaments, vessels, nerves, pelvic floor muscles, and external sex organs
- All structures are anatomically accurate in every detail
- Can easily be taken apart using magnetic connections
- Extremely durable material, comes on sturdy base

21 x 28 x 31 cm; 3.12 kg

**M-1013282**



*Can be taken apart easily for closer study*



### 3B SMART ANATOMY

#### Male Pelvis, 3-part

Like M-1013281 but without the ligaments. The left half of the fifth lumbar vertebra is held together by magnets and can also be removed.

19 x 28 x 24.5 cm; 1.35 kg

**M-1013026**

### 3B SMART ANATOMY

#### Male Pelvis with Ligaments, 2-part

This 2-part model is a natural cast of a male, bone pelvis with ligaments. It shows the following structures in great detail: both hip bones, pubic symphysis, sacrum and coccyx, and the fifth lumbar vertebra with intervertebral disc. Part of the cauda equina is visible in the vertebral canal. A median section has been placed through the fifth lumbar vertebra, the sacrum and the coccyx, so that the pelvis, which is connected by practical magnets, can be split easily into two halves.

19 x 28 x 24.5 cm; 1.66 kg

**M-1013281**

## ► THE MOST COMPREHENSIVE FEMALE PELVIS MODEL!

### 3B SMART ANATOMY

#### Female Pelvis with Ligaments, Vessels, Nerves, Pelvic Floor, Organs, 6-part

This original cast of a female pelvis shows the topography of bones, ligaments, vessels, nerves, pelvic muscles and female genital organs in life-size. For close up study, the following parts can be removed and disassembled into two halves: rectum, uterus with fallopian tubes, ovaries and vagina. The pelvic floor includes partially removable external anal sphincter, external urethral sphincter, deep and superficial transverse perineal and bulbospongiosus. The pelvis can be disassembled through a midsagittal section (fifth lumbar vertebra, sacrum and coccyx) to reveal a part of the cauda equina in the vertebral canal.

- Magnetic connections for fast demonstrations
  - Study of complex anatomical areas made easy
- 19 x 27 x 19 cm; 1.6 kg

**M-1000288**

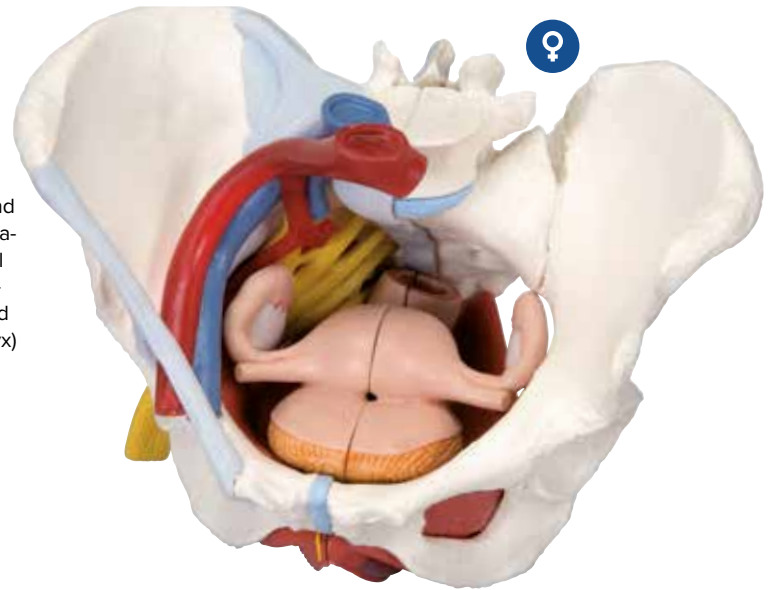

*The pelvic muscles are shown in great detail*



### 3B SMART ANATOMY

#### Female Pelvis with Ligaments, Muscles and Organs, 4-part

This life-size model of a female pelvis represents detailed information about the topography of bones, ligaments, pelvic floor muscles and female pelvic organs. The right half shows the bones with pelvic ligaments and left half of the pelvis contains the muscles of the pelvic floor. A partially removable bulbospongiosus demonstrates the vestibular bulb and Bartholin gland. The removable, midsagittally sectioned female pelvic organs (urinary bladder, vagina, uterus and rectum) demonstrate the relationship to the muscles of the pelvic floor within its openings for urethra, vagina and rectum.

19 x 27 x 19 cm; 1.3 kg

**M-1000287**

### 3B SMART ANATOMY

#### Female Pelvis with Ligaments, 3-part

This life-size model represents an original cast of a bony female pelvis with all major ligaments on the right side and shows all the details of the hip bones, the pubic symphysis, the sacrum and the coccyx, and the fifth lumbar vertebra with intervertebral disc. A midsagittal section through the fifth lumbar vertebra, sacrum and coccyx, allow both halves of the pelvis to be disassembled revealing a part of the cauda equina in the vertebral canal. The left half of the fifth lumbar vertebra is removable.

19 x 27 x 19 cm; 1 kg

**M-1000286**



### 3B SMART ANATOMY

#### Female Pelvis, 3-part

Like M-1000286 but without ligaments.

19 x 27 x 19 cm; 0.9 kg

**M-1000285**

# SKULL MODELS



SCAN THE QR CODE ON P. 174 FOR A FREE  
3B SMART ANATOMY DEMO VERSION

+

All 3B Scientific® human skull models have been cast from real specimens, guaranteeing life-like detail and anatomical precision. You will see even the finest structures in these durable models made for everyday use!

- + Anatomical detail and precision
- + Realistically cast dentition
- + Durable, non-toxic material
- + Manufactured for everyday use



*Magnetic connections for easy, hands-on demonstrations*

#### **Other features of all skull models of the classic series include:**

- Highly accurate representation of the fissures, foramina, processes, sutures etc.
- Mandible is mounted on a spring to easily demonstrate natural movement
- High quality original human skull cast
- Handmade from hard, unbreakable plastic

#### **> LIFE-LIKE DETAIL!**

#### **3B SMART ANATOMY Classic Skull, 3-part**

The 3-part standard version skull is an excellent choice for basic anatomical studies or an attractive medical gift. It can be disassembled easily into the skull cap, the base of skull and the mandible.

20 x 13.5 x 15.5 cm; 0.6 kg

**M-1020159**



*Surface detail*



#### **3B SMART ANATOMY Classic Skull with Numbered Details, 3-part**

In addition to the features of the classic skull, this version comes with hand-painted, numbered details: the different bones and features like the suture lines of the bony plates are highlighted for ease in identifying all important anatomical structures. This skull comes complete with a guide naming all numbered parts.

20 x 13.5 x 15.5 cm; 0.7 kg

**M-1020165**



*Hand-painted and numbered*

#### **3B SMART ANATOMY Classic Skull with Painted Muscle, 3-part**

In addition to all features of the classic skull, this version is didactically hand-painted to show the insertions and origins of the muscles on the left side of the skull. The cranial bones and structures are numbered on the right side. Altogether, over 140 anatomical details can be identified utilizing this top quality model. The jaw hinges with a spring to simulate realistic movement. The detail and precision make it a great anatomy teaching tool!

20 x 13.4 x 15 cm; 0.7 kg

**M-1020168**





**3B SMART ANATOMY**  
**Classic Skull with 5-part Brain**

The 5-part brain is midsagittally divided and is cast from an original specimen for anatomical accuracy and detail.

*The left side of the brain can be disassembled into the following parts:*

- Frontal and parietal lobe
- Temporal and occipital lobe
- Encephalic trunk
- Cerebellum

20 x 13.5 x 15.5 cm; 1.1 kg

**M-1020162**

*Demonstrate the functions of masticatory muscles!*

**3B SMART ANATOMY**

**Classic TMJ Skull with Masticatory Muscles, 2-part**

Ideally suited for patient education, allied health instruction, anatomy studies, and as a medical-legal visual aid. In addition to all features of the classic skull model, this version includes the masticatory muscles (masseter, temporal, medial and lateral pterygoid muscles). They are made of durable, elastic bands for functional demonstrations of movement of the jaw: jaw occlusion, the initial stage of jaw opening, and the movements of the mandible to the side and front. This makes the skull a valuable tool for demonstrations about temporomandibular joint disorders both for patients and students. The skullcap is removable and the model is cast from an original specimen, guaranteeing a highly accurate anatomical representation.

20 x 13.5 x 15.5 cm; 0.7 kg

**M-1020169**



To see additional images and to zoom in on details, visit [3bscientific.com](http://3bscientific.com)



**3B SMART ANATOMY**  
**Classic Skull with Opened Lower Jaw, 3-part**

In addition to all features of the classic skull, this version includes an opened lower jaw, making it perfect for teaching dental anatomy. It is highly detailed, and the opened part shows the dental roots with vessels and nerves. The cranial bones, bone components, fissures, foramina and other structures are numbered for educational purposes. The cranial sutures are shown in color, as are the meningeal vessels and venous sinuses. Over 100 features are identified in the accompanying product guide.

20 x 13.5 x 15.5 cm; 0.7 kg

**M-1020166**

**3B SMART ANATOMY**

**Classic Skull, Painted, with Opened Lower Jaw, 3-part**

This deluxe version of the classic skull series combines the different features all in one! It is an extensive educational tool concerning the anatomy of the skull and includes the following features:

- Hand-painted muscle origins and insertions
- Opened lower jaw exposing dental roots, vessels and nerves
- Numbered parts for easy identification
- Highlighted suture lines of bony plates
- 3-part skull can easily be disassembled
- High quality, durable material for everyday use
- Movable lower jaw

20 x 13.5 x 15.5 cm; 0.7 kg

**M-1020167**



**Human Skull Models on Cervical Spine, 4-part Flexibly Mounted on the Cervical Spine**

C1, C2 and C7 are colored in the didactic version to better show their relation. To complete this demonstration, the models also exhibit the hindbrain, spinal cord, spinal nerves of the cervical spine, vertebral arteries, basilar artery as well as the rear cerebral arteries.

**Manufactured to the highest quality standards:**

- Anatomically precise cast from original human skull
- Handmade from extremely durable, non-toxic plastic
- Highly accurate representation of the fissures, foramina, processes and sutures
- Magnetic connections: can easily be disassembled into skullcap, base of skull and mandible

**3B SMART ANATOMY  
Didactic Human Skull Model on Cervical Spine, 4-part**

This didactic skull model utilizes 19 distinctive colors to represent the shapes and relationships of the various bone plates of the skull. Mounted on stand.

17.5 x 17.5 x 30 cm; 0.6 kg

**M-1020161**



**3B SMART ANATOMY  
Human Skull Model on Cervical Spine, 4-part, naturally colored in bone like shades**

Mounted on stand.

20 x 13.5 x 15.5 cm; 0.6 kg

**M-1020160**



**The most effective way to learn:  
Hands-on with visual support!**

**Beauchene Adult Human Skull Models, 22-part**

The human skull consists of many individual bones that gradually grow together as the development proceeds. This human skull kit is a natural cast that makes the complex anatomical structures of the skull easy to understand. The skulls can be taken apart into the following 22 bones:

- Parietal bone (left and right)
- Occipital bone
- Frontal bone
- Temporal bone (left and right)
- Sphenoid bone
- Ethmoid bone
- Vomer bone
- Zygomatic bone (left and right)
- Upper jaw (maxilla) with teeth (left and right)
- Palatine bone (left and right)
- Nasal concha (left and right)
- Lacrimal bone (left and right)
- Nasal bone (left and right)
- Lower jaw (mandible) with teeth

**3B SMART ANATOMY**

**A. Beauchene Adult Human Skull Model – Didactically Colored, 22-part**

The 22 bones are depicted in 9 different didactic colors so that the individual skull bones are easy to distinguish.

21 x 14 x 16 cm; 0.7 kg

**M-1000069**

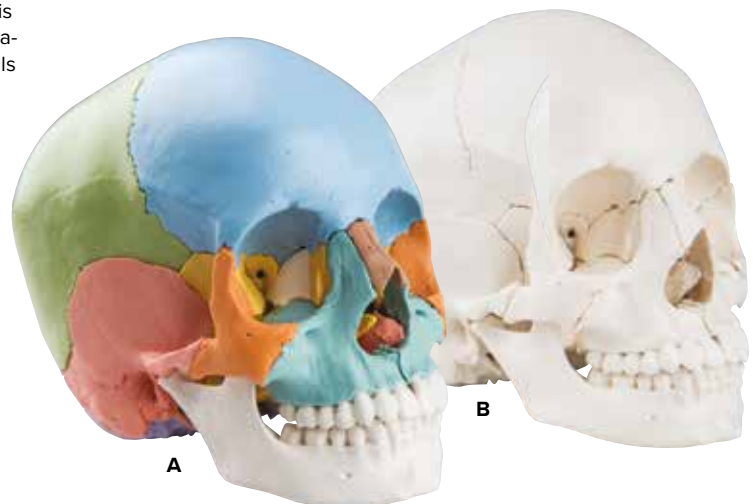

**3B SMART ANATOMY**

**B. Beauchene Adult Human Skull Model – Bone Colored, 22-part**

This version of the 22-part Beauchene skull has the same features as the didactic version, but is colored like natural bone.

21 x 14 x 16 cm; 0.7 kg

**M-1000068**



### 3B SMART ANATOMY

#### Deluxe Human Demonstration Dental Skull Model, 10-part

Exceptional quality and anatomical detail!

The skullcap is removable and the base of the skull is mid-sagittally divided. The anatomy of the human skull is easy to learn and teach using this model.

**The model features the following details fitted with flaps that can be opened to view internal structures:**

- Frontal sinus, perpendicular lamina and vomer can be opened to view the lateral nose wall and sphenoidal sinus
- Left side temporal bone can be removed and folded up in the area of the tympanic membrane
- Maxilla and mandible of the skull are opened to reveal the alveolar nerves
- Right side the temporal bone is opened to reveal the sigmoid sinus, the facial nerve canal and the semicircular ducts
- Right side flap at maxillary sinus and the right half of the mandible, so that the dental roots of the premolars and molars of the lower jaw can also be viewed

The natural occlusion and the individual removal and replacement of each tooth also make this skull especially interesting for dentists. This is a spectacular model whether you use it as a dental skull or for other purposes.

28 x 22.5 x 18.5 cm; 1.5 kg

**M-1000059**



### 3B SMART ANATOMY

#### Neurovascular Skull Model

This life size human adult skull comes on seven cervical vertebrae and is mounted on a sturdy stand. It is a valuable tool to demonstrate the anatomy and positioning of the arteries and the nerves on the skull.

The skull cap is removable and reveals the main nerves and arteries on the floor of the cranium. With this skull, you can demonstrate the 12 cranial nerves (their branches) that arise directly from the brain and pass through separate apertures in the skull.

17 x 16 x 30 cm; 1.3 kg

**M-1005108**



### 3B SMART ANATOMY

#### Skull with Facial Muscles

Easily demonstrate causes of temporo-mandibular disorders and other dysfunctional disturbances of the masticatory muscles with this high quality skull model. It is anatomically precise and manufactured specifically to withstand wear and tear from educational use. The right half features the face and mastication muscles. They can easily be differentiated by color. Cranium and m. masseter are easily detachable to reveal the structures underneath. The left side shows hand-painted muscle origins and insertions to further clarify the structural interaction of muscles and skull bones. The jaw is movable and due to the flexible musculature the rudimentary chewing motion can be demonstrated. Made in Germany and cast from an original human skull, using our highest quality material.

18 x 18 x 25 cm; 1.08 kg

**M-1020181**



## 3B BONElike™ material for unrivalled realism and detail!

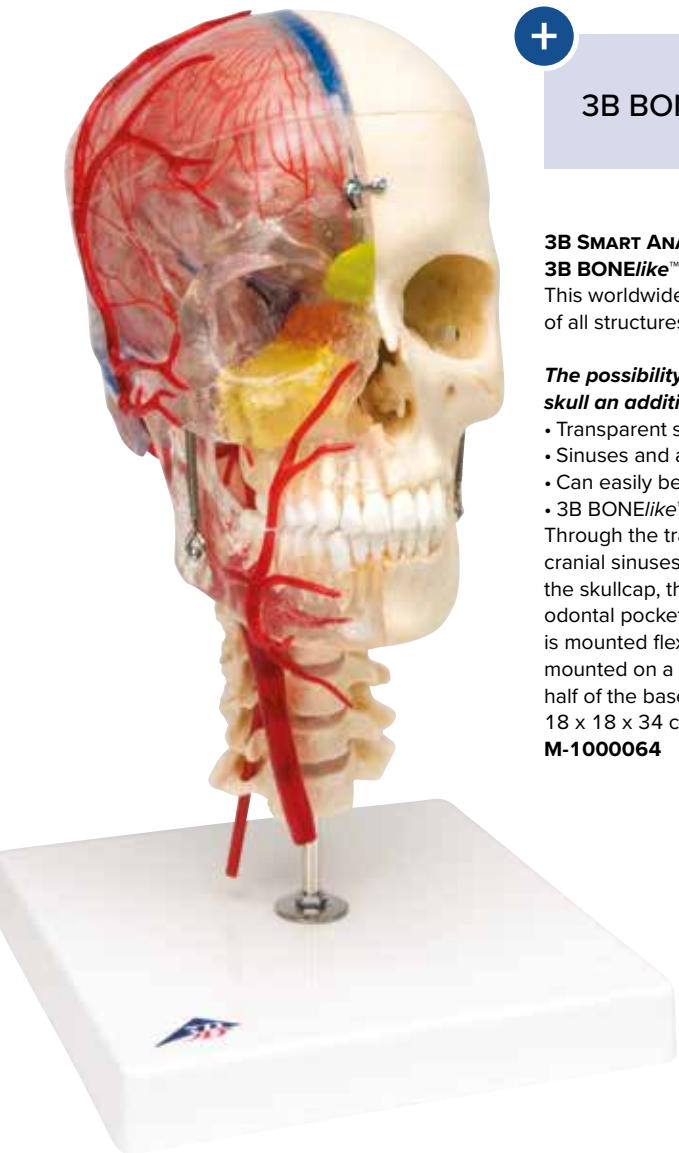

### 3B SMART ANATOMY

#### 3B BONElike™ Half Transparent Human Skull Model, 7-part

This worldwide unique and high quality didactic skull is a great tool to understand the anatomy of all structures inside the skull.

*The possibility to transfer the visible parts in the transparent half to the bony half give this skull an additional didactic value:*

- Transparent side helps understand the internal anatomy of the skull
- Sinuses and arteries are marked in color for easy identification
- Can easily be disassembled into 7 parts for close up study
- 3B BONElike™ material looks and feels real

Through the transparent right half of the skull, you can easily locate the paranasal and the cranial sinuses, as well as the neck and face arteries, as all of these are color-coded. Through the skullcap, the position of the brain and the course of the sinuses can be visualized. The periodontal pockets and tooth roots can be viewed through the transparent side of the jaw, which is mounted flexibly to demonstrate the masticator movements of the human skull. The skull is mounted on a cervical spine and can be disassembled into both halves of the skullcap, the left half of the base of skull, the nasal septum, the complete mandible and a brain half.

18 x 18 x 34 cm; 0.86 kg

**M-1000064**



### 3B SMART ANATOMY

#### 3B BONElike™ Half transparent Human Skull Model, 8-part

One half of this skull is transparent and the other is bony. It offers a topographic comparison of structures that are not visible in other skull models. The teeth can be taken out and the outer masticatory muscles are represented on the bony half. Can be disassembled into both halves of the skullcap and base of skull, the nasal septum, the complete mandible and both masticator muscles.

16 x 14 x 20.5 cm; 0.54 kg

**M-1000063**

### 3B SMART ANATOMY

#### 3B BONElike™ Human Bony Skull Model, 6-part

This version shows a complete skull in median-sagittal section.

*It can be disassembled into two halves consisting of:*

- The calvarium and the base of the skull
- The nasal septum and complete mandible
- For a demonstration of masticatory motion, the mandible is mounted flexibly.

16 x 13.5 x 20.5 cm; 0.5 kg

**M-1000062**



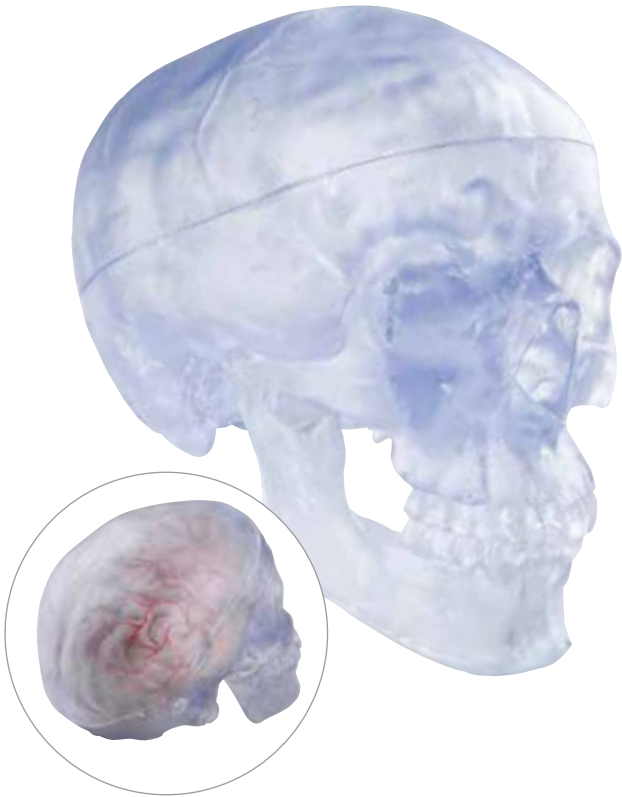

**3B SMART ANATOMY**

**Transparent Classic Human Skull Model, 3-part**

A great addition to any educational collection! Use this unique transparent replica of the human skull to study internal structures!

- High-quality original casts
- Skull is handmade of hard, unbreakable plastic
- Highly accurate representation of the fissures, foramina, processes, sutures
- Can be disassembled into Skull Cap, Base of Skull and Mandible
- A 5-part classic brain can be inserted into the skull.

See page 236 for details.

20 x 13.5 x 15.5 cm; 0.6 kg

**M-1020164**



*You can add a brain (not included)*



**3B SMART ANATOMY**

**Fetal Skull Model**

Natural cast of a fetal head in the 30<sup>th</sup> week of pregnancy showing the characteristics of prenatal development. The fontanelles, which become bone over time, are clearly visible on the skull. Sutures will form along the bony plates helping fuse the skull as the individual ages. Delivered on stand.

18.5 x 14.5 x 14 cm; 0.2 kg

**M-1000058**

**3B SMART ANATOMY**

**Fetal Skull Model, without stand (not shown)**

14 x 9 x 9 cm; 0.15 kg

**M-1000057**



**Glow in the Dark Skull Model**

All anatomical details are not only true to life, but also glow in the dark! Great as a gift for those students or friends needing a flash of inspiration.

20 x 13.5 x 15.5 cm; 0.6 kg

**M-1020163**



**3B SMART ANATOMY**

**Mini Human Skull Model, 3-part**

It precisely depicts the anatomical structures of the human skull in a manner that is true to detail and can be disassembled into skullcap, base of skull and mandible.

10 x 8 x 8 cm; 0.1 kg

**M-1000041**

# MUSCULATURE MODELS



SCAN THE QR CODE ON P. 174 FOR A FREE  
3B SMART ANATOMY DEMO VERSION

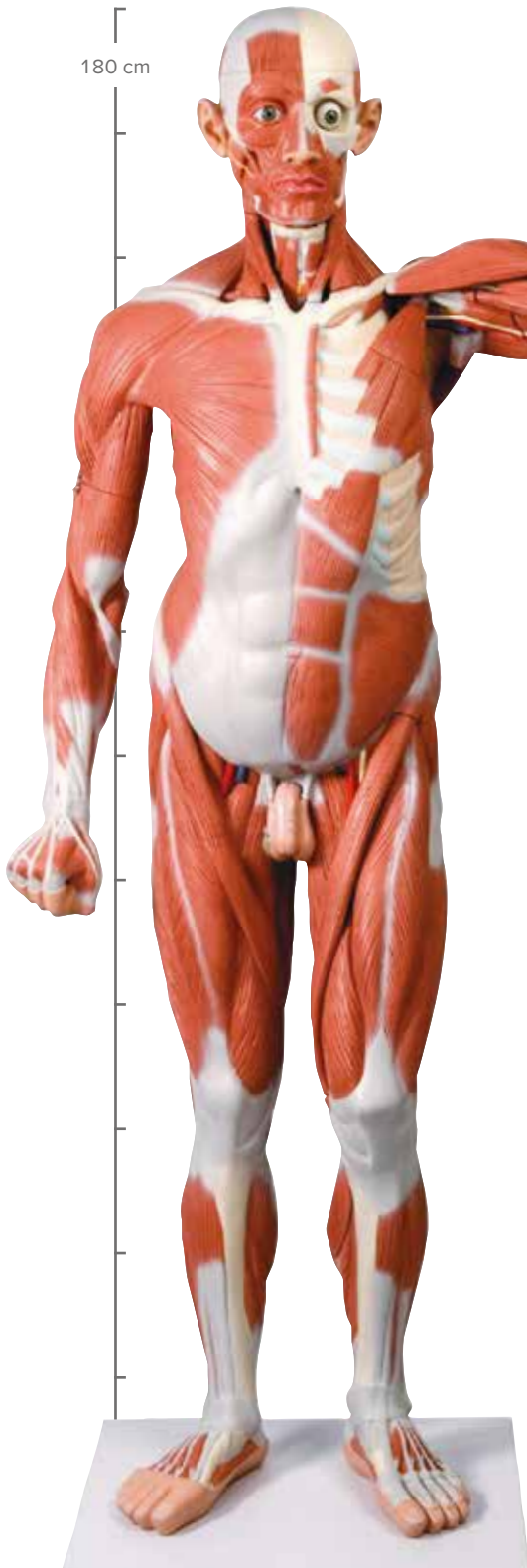

## 3B SMART ANATOMY Life-Size Male Muscle Figure, 37-part

This life-size human muscular model shows the deep and superficial musculature of the entire body in great detail. The extraordinary accuracy of the human muscular system makes this masterpiece a unique tool for instructions even in large lecture halls. It is manufactured to precise anatomical detail, is made from a durable, non-toxic plastic and painted in didactic colors. Comes on a sturdy base, slightly raised for better visibility.

### **The following parts can be removed for close up study:**

- Skull cap
- 6-part brain
- Eyeball
- Breast and abdominal wall
- Both arms
- 2-part larynx
- 2 lungs
- Diaphragm
- 2-part stomach
- Liver with gall bladder
- Kidney
- Whole intestine system
- Bladder half
- 2-part penis
- 10 muscles (Three arm and leg muscles, 2 thoracic muscles, sternocleidomastoid muscles and gluteus maximus)

180 x 110 x 50 cm; 53 kg  
**M-1001235**

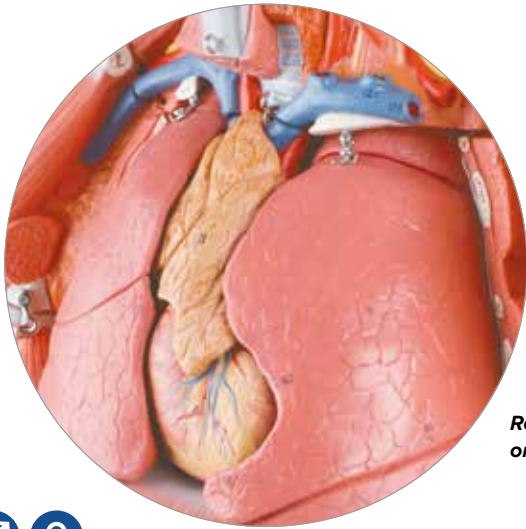

**Removable organs**



**3B SMART ANATOMY**

**3/4 Life-Size Dual Sex Muscle Figure, 45-part**

This muscle figure is the finest teaching tool available! Standing over 4 1/2 feet tall, this 3/4 life-size human replica depicts deep and superficial musculature in amazing detail and realistic color in addition to the body's major nerves, vessels, tissues and organs in exquisite detail. The internal organs are removable (45 parts in total) to reveal the fundamental interrelationships of human morphology.

This dual sex muscle figure has interchangeable genital inserts and a female mammary gland as well as a detailed multilingual product manual identifying over 600 numbered structures, explained in the included guide. Hand-painted and mounted on a stable metal stand.

**Includes the following features:**

- 5 arm/ shoulder muscles
- 8 leg/ hip muscles
- 2-part removable heart
- 5-part head with removable brain
- 2-part removable lungs
- 2-part stomach

Removable 4-part male and 2-part female genital inserts

Detachable arms, leg, head, and abdominal wall for detailed study

**Hands-on anatomy education at its best:**

Easily remove the calvarium to view the 3-part removable brain. Look beneath the liver to reveal the gallbladder and bile duct. Peer inside the appendix, stomach lungs, heart or kidney. Remove and view the details of 13 different muscles of the arms and legs.

138 x 50 x 32 cm; 12.4 kg

**M-1013881**



**3B SMART ANATOMY**

**3/4 Life-Size Female Muscle Figure, 23-part (not shown)**

This Female Muscle Figure provides the same quality characteristics as the dual sex model above but is delivered without internal organs, brain, and male genitalia providing for unobstructed study of the human musculature.

**The female muscle figure includes the following features:**

- 5 arm/shoulder muscles
- 8 leg/hip muscles
- Detachable arms, leg, head and abdominal wall for detailed study

138 x 45 x 32 cm; 11.2 kg

**M-1013882**



**> 3/4 LIFE-SIZE MODEL**

➤ A SPACE SAVING ALTERNATIVE WITH AMAZING DETAIL AT HALF LIFE-SIZE!



### 3B SMART ANATOMY

#### 1/2 Life-Size Complete Dual Sex Muscle Figure, 33-part

This convenient and complete human musculature model is the perfect choice for thorough demonstrations of human musculature and internal organs where space is a concern. Exquisitely hand-detailed and complete with 33 removable parts, this human muscular figure represents the finest quality at an affordable price. Painted by hand in realistic colors, this human anatomy model comes complete with stand.

#### *Includes the following removable parts:*

- 5 arm/shoulder muscles
  - 8 leg/hip muscles
  - 2-part heart
  - 2-part brain
  - 2 lungs
  - 2-part male and 2-part female genital inserts
  - 2-part intestine system
  - Detachable breast/belly covering and arms for detailed study
  - Almost 400 numbered structures identified in the manual
- 84 x 30 x 30 cm; 4.95 kg

**M-1019231**



### 3B SMART ANATOMY

#### 1/2 Life-Size Complete Female Muscle Figure, 21-part (not shown)

Offering the same exceptional value as the dual sex version above, this version is delivered without internal organs, brain and male genitalia.

84 x 30 x 30 cm; 4.1 kg

**M-1019232**



### 3B SMART ANATOMY

#### 1/3 Life-Size Muscle Figure, 2-part

The 1/3 life-size mini muscle figure shows the superficial musculature. It is accurately reproduced and detailed in life-like. The chest plate is removable from the muscular figure to reveal the internal organs and the right side contains a female mammary gland. 125 numbered and identified structures of the human anatomy on base.

57 x 25 x 18 cm; 2.1 kg

**M-1000212**





## ► LIFE-SIZE MODEL



### 3B SMART ANATOMY

#### Life-Size Dual Sex Human Figure, 39-part

This life-size, dual sex model facilitates an understanding of human anatomy like no other human anatomy model in the world! One half exposes the musculature, while the other shows the skin for a more realistic effect that puts the human touch back in. The figure can be disassembled easily to show the inner structures and organs in amazing detail.

#### Altogether, 39 component parts can be removed:

- 2-part head
- Brain half
- M. Sternocleidomastoid
- M. Deltoideus
- M. Biceps brachii
- M. Triceps brachii
- M. Palmaris longus with m. Flexor carpi radialis
- M. Brachioradialis with m. Extensor carpi radialis
- Skin of the left arm
- Muscled leg, upper part
- Muscled leg, lower part
- Skin of the left leg
- Abdominal cover
- Mammary gland
- 2 removable lungs
- 2-part removable heart
- Removable Liver
- 2-part removable stomach
- Removable kidney half
- 4-part removable intestines
- 3-part female genital insert with embryo
- 4-part male genital
- M. Satorius
- M. Gluteus maximus
- M. Rectus femoris
- M. Gastrocnemius
- M. Biceps femoris cap. L. with m. semitendinosus

Comes with wooden roller base and includes free anatomy software!

Caucasian appearance

174 cm; 40.7 kg

**M-1000209**



### 3B SMART ANATOMY

#### Life-Size Dual Sex Asian Human Figure, 39-part

Same features as M-1000209 above, but with Asian appearance.

174 cm; 40.7 kg

**M-1000208**

174 cm

**39 amazingly detailed components, plus free software!**



**On wheels, easy to move**

► ON REMOVABLE STAND  
FOR CLOSER STUDY!



**3B SMART ANATOMY**

**Life-Size Deluxe Muscle Leg, 7-part**

Extremely detailed model, shows even the finest structures. This life-size muscular leg model can be disassembled into upper and lower leg.

**The following muscles can be detached from the leg:**

- Long head of biceps femoris muscle with semitendinosus muscle
- Sartorius muscle
- Gluteus maximus muscle
- Rectus femoris muscle
- Gastrocnemius muscle

This high quality muscular leg model is supplied on a base.  
100 cm; 7 kg

**M-1000352**



**3B SMART ANATOMY**

**Life-Size Lower Muscle Leg with Detachable Knee, 3-part**

Life-size replica of lower leg, ankle, and foot. On removable base for close up study.

**Features of the lower muscular leg:**

- Detachable knee cross section to expose the articular surfaces
- Detachable gastrocnemius muscle

58 cm; 2.6 kg

**M-1000353**

**3B SMART ANATOMY**

**3/4 Life-Size Muscle Leg, 9-part**

The muscular leg model illustrates both the superficial and deeper muscles, eight of which are removable. Tendons, vessels, nerves and bone components of the left leg and foot are shown in great detail. All parts are numbered for easy identification.

Delivered on removable stand.

77 x 26 x 26 cm; 4 kg

**M-1000351**



**3B SMART ANATOMY**

**Life-Size Deluxe Muscle Arm, 6-part**

The following muscles can be detached in this life-size muscular arm model:

- Deltoid muscles
- Biceps muscle of arm
- Triceps muscle of arm
- Long palmar muscle with radial flexor muscle of wrist
- Brachioradial muscle with radial extensor muscle of wrist

Supplied on base. 70 cm; 3 kg

**M-1000347**

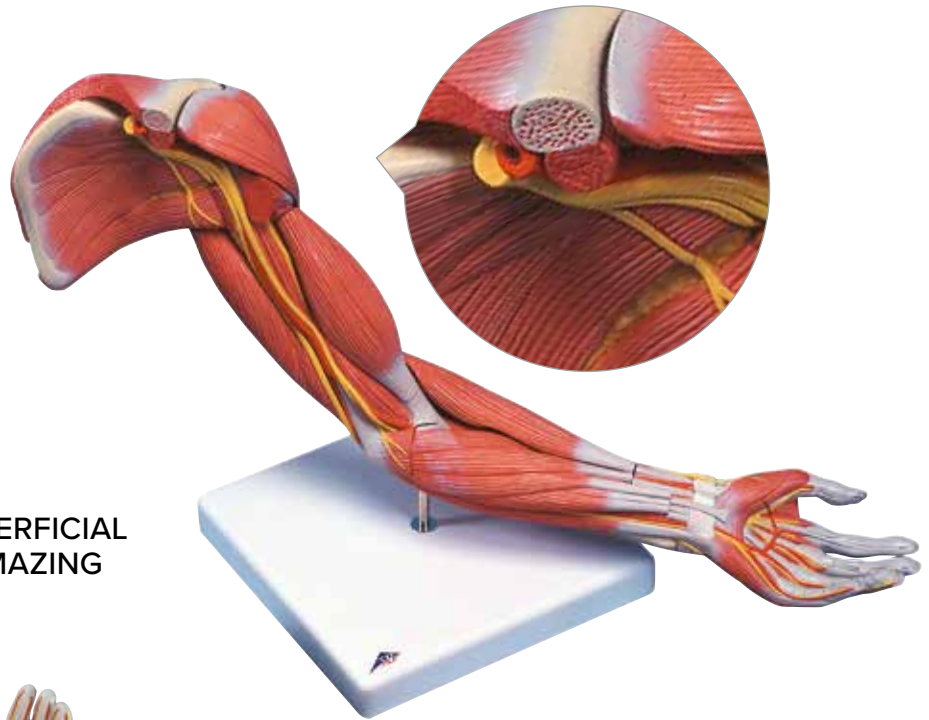

**> ILLUSTRATES BOTH THE SUPERFICIAL AND DEEPER MUSCLES IN AMAZING DETAIL!**

**3B SMART ANATOMY**

**3/4 Life-Size Muscle Arm, 6-part**

This 3/4 life-size muscled arm model illustrates both the superficial and deeper muscles, five of which are removable. Tendons, vessels, nerves and bone components of the left arm and shoulder are shown in great detail on this high quality muscle model. Over 70 numbered parts for easy identification, named in the product manual. Delivered on removable stand.

60 x 18 x 18 cm; 1.9 kg

**M-1000015**

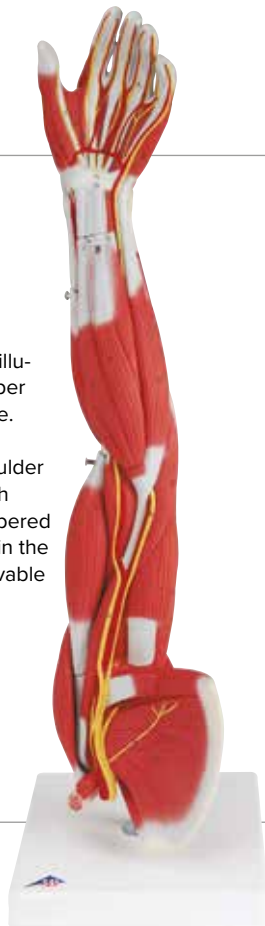

**3B SMART ANATOMY**

**3B MICROanatomy™ Muscle fiber 10,000 times magnified**

Illustrates a section of a skeletal muscle fiber and its neuromuscular end plate. The muscle fiber is the basic element of the diagonally striped skeletal muscle. This high quality muscle fiber replica brings a hands-on understanding of the human muscle to any classroom.

23.5 x 26 x 18.5 cm; 1.1 kg

**M-1000213**

# TORSO MODELS



SCAN THE QR CODE ON P. 174 FOR A FREE 3B SMART ANATOMY DEMO VERSION.



SEE PAGES 228 AND 229 FOR A DETAILED FEATURE COMPARISON OF ALL TORSO MODELS

## MANUFACTURED TO PRECISE ANATOMICAL DETAIL!

**High quality models at great prices! 3B Scientific® torso models are:**

- Non-toxic, extremely durable material for hands-on demonstrations hand-painted to show every detail in realistic colors
- Anatomical precision for medical education on every level

**Choose from a variety of torsos with different features depending on your needs:**

- Male
- Female
- Dual sex
- Different ethnicities
- Focusing on varying aspects of anatomy



PLEASE VISIT [3BSCIENTIFIC.COM](http://3BSCIENTIFIC.COM) FOR ADDITIONAL IMAGES AND TO ZOOM IN ON MORE DETAIL.

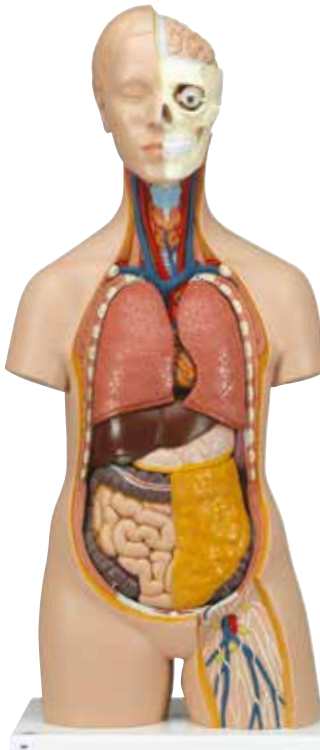

### 3B SMART ANATOMY

#### Classic Gender Neutral Torso, 12-part

This gender neutral, life-size torso is hand-painted, true to detail, and made of high-quality plastic.

**The following components are removable and reveal the inner anatomy:**

- 2-part head
  - 2-part removable heart
  - 2 lungs
  - Stomach
  - Liver with gallbladder
  - 2-part intestinal tract
  - Front half of kidney
- Includes 3B Scientific® Torso Guide, mounted on sturdy base. Light skin.

87 x 38 x 25 cm; 4.6 kg

**M-1000186**



**Parts can be removed easily for detailed study**

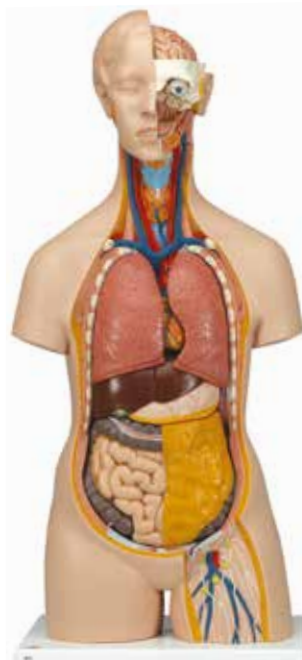

### 3B SMART ANATOMY

#### Classic Gender Neutral Torso, 14-part

This 14-part anatomically correct human torso model is an educational tool of true quality. The gender neutral torso is hand-painted in true to life detail and made of high-quality plastic for hands-on education. It is mounted on a sturdy base so students can safely disassemble it.

**The following parts can be removed:**

- 3-part head
- 2 lungs
- 2-part heart
- Stomach
- Liver with gallbladder
- 2-part intestinal tract
- Front half of kidney
- Front half of urinary bladder

Includes 3B Scientific® Torso Guide. Light skin.

87 x 38 x 25 cm; 5.9 kg

**M-1000190**



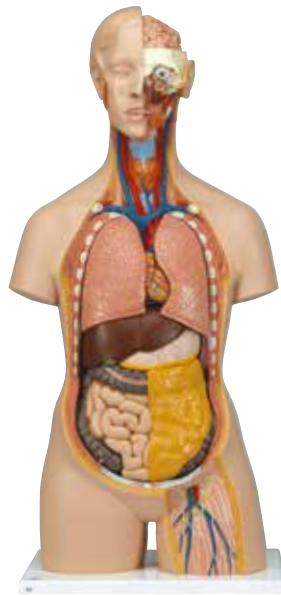

**Opened back reveals the anatomy of the spine from cerebellum to coccyx**

### 3B SMART ANATOMY

#### Classic Gender Neutral Torso with Opened Neck and Back, 18-part

This human gender neutral torso model has the unique feature of an open neck and back section going from the cerebellum to the coccyx. Vertebrae, intervertebral discs, spinal cord, spinal nerves, vertebral arteries, and many other features are represented in detail in this hand-painted and highly detailed model.

**Includes the following removable parts and organs:**

- 7<sup>th</sup> thoracic vertebra removable
- 6-part head
- 2 lungs
- 2-part heart
- Stomach
- Liver with gallbladder
- 2-part intestinal tract
- Front half of kidney
- Front half of urinary bladder

Includes 3B Scientific® Torso Guide. Mounted on sturdy base for hands-on education. Light skin.

87 x 38 x 25 cm; 5.8 kg

**M-1000193**

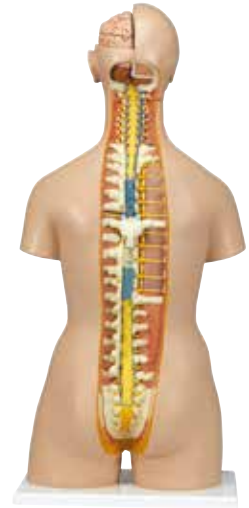
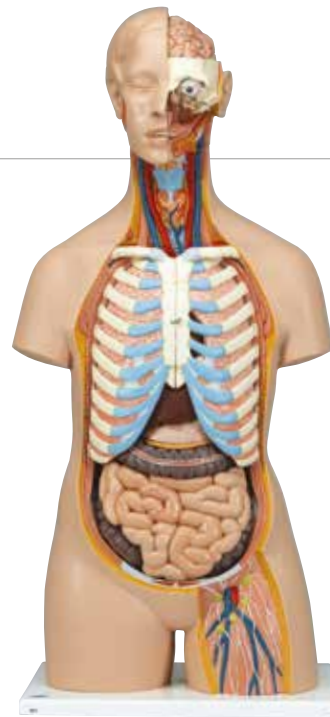

### 3B SMART ANATOMY

#### Classic Gender Neutral Torso with Open Back, 21-part

This top of the line gender neutral torso comes with additional removable parts and an opened back section going from the cerebellum to the coccyx. Vertebrae, intervertebral discs, spinal cord, spinal nerves, vertebral arteries, and many other features are represented in detail in this detailed replica of the human anatomy. It is mounted on a sturdy base for safe anatomical demonstrations.

**The following parts and organs can easily be removed:**

- 7<sup>th</sup> thoracic vertebra removable
- 6-part head
- 2-part stomach
- Lungs
- 2-part heart
- Liver with gallbladder
- 4-part intestinal tract
- Kidney half
- Bladder half
- Open back
- Brain

Includes 3B Scientific® Torso Guide. Light skin.

87 x 38 x 25 cm; 6.5 kg

**M-1000192**

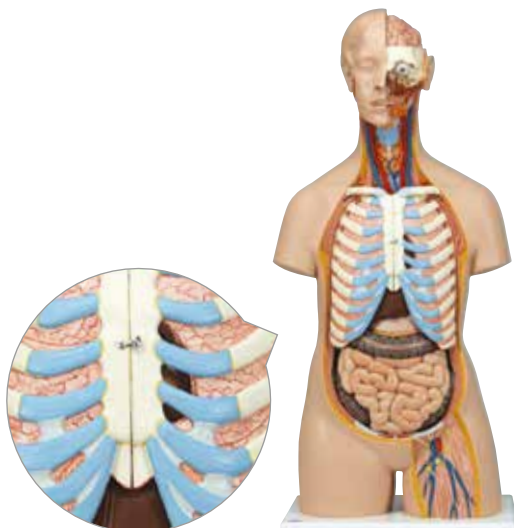

### 3B SMART ANATOMY

#### Classic Gender Neutral Torso, 16-part

This life-size human torso model comes with 16 removable parts, each hand-painted for amazingly realistic details.

- Hand-painted for realistic colors and amazing detail
- Made of durable, high quality plastic
- 16 removable parts for closer study

**The torso model contains the following removable parts:**

- 3-part head
- 2 lungs with sternum and rib attachments

- 2-part heart
- Stomach
- Liver with gallbladder
- 4-part intestinal tract
- Front half of kidney
- Front half of urinary bladder

Includes 3B Scientific® Torso Guide. Mounted on sturdy base for hands-on education. Light skin.

87 x 38 x 25 cm; 6.8 kg

**M-1000188**

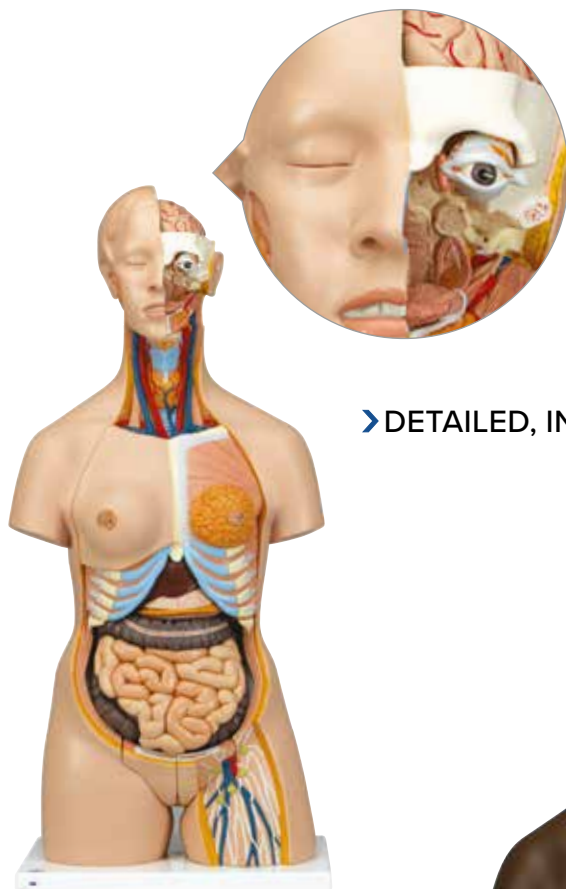

**3-part head with removable brain half and eye**

➤ DETAILED, INSIDE AND OUT!

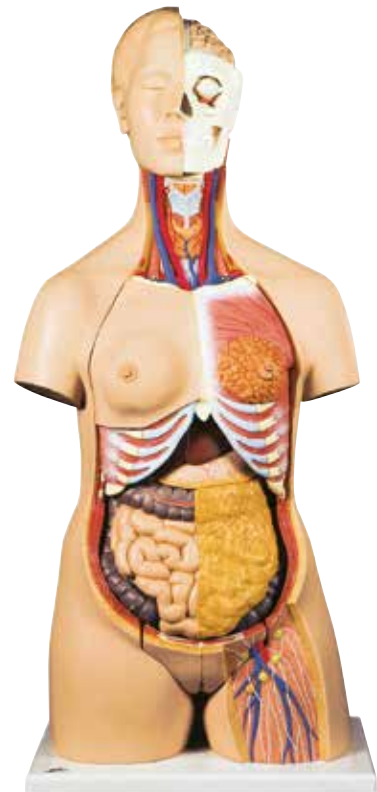

**3B SMART ANATOMY  
Dual Sex Torso, 24-part**

This life-size human torso model offers impressive detail with 24 removable parts. Use it to answer all questions regarding internal human anatomy. Manufactured for everyday use, extremely durable material for a long lasting demonstration model.

**For close-up study the following parts and organs can be removed:**

- 3-part head
- 2-part stomach
- 4-part intestinal tract
- Female chest wall
- 2 lungs
- 2-part heart
- Liver with gall bladder
- Front half of kidney
- 4-part male genital insert
- 3-part female genital insert with fetus

Hand-painted in realistic colors, delivered complete with the 3B Scientific® Torso Guide and mounted on sturdy base. Light skin.

87 x 38 x 25 cm; 7.5 kg

**M-1000196**

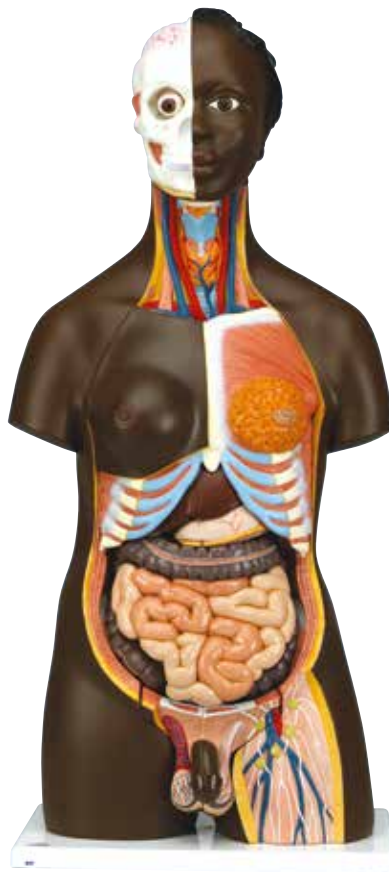

**3B SMART ANATOMY  
Dual Sex Torso, Dark Skin, 24-part**

This life-size, deluxe human torso model comes with all features of the Dual Sex Torso, 24-part (M-1000196) but with dark skin.

87 x 38 x 25 cm; 7.5 kg

**M-1000202**

**3B SMART ANATOMY  
Dual Sex Torso, 20-part**

Detailed demonstration model for human anatomy focusing on inner organs. All parts are easy to remove and the torso can be switched from male to female easily!

***This life-size, high quality human torso contains these removable parts and organs:***

- 2-part head
- Female chest wall
- 2 lungs
- 2-part heart
- Stomach
- Liver with gall bladder
- 2-part intestinal tract
- Front half of kidney
- 4-part male genital insert
- 3-part female genital insert with fetus

All organs are hand-painted for a quality product with realistic colors. Delivered on sturdy base and complete with the 3B Scientific® Torso Guide. Light skin.

87 x 38 x 25 cm; 7.3 kg

**M-1000197**

**3B SMART ANATOMY  
Asian appearance, 18-part**

Delivered with 1-part head and without female chest wall, all other features like the Dual Sex Torso, 20-part, M-1000197.

**M-1000199**



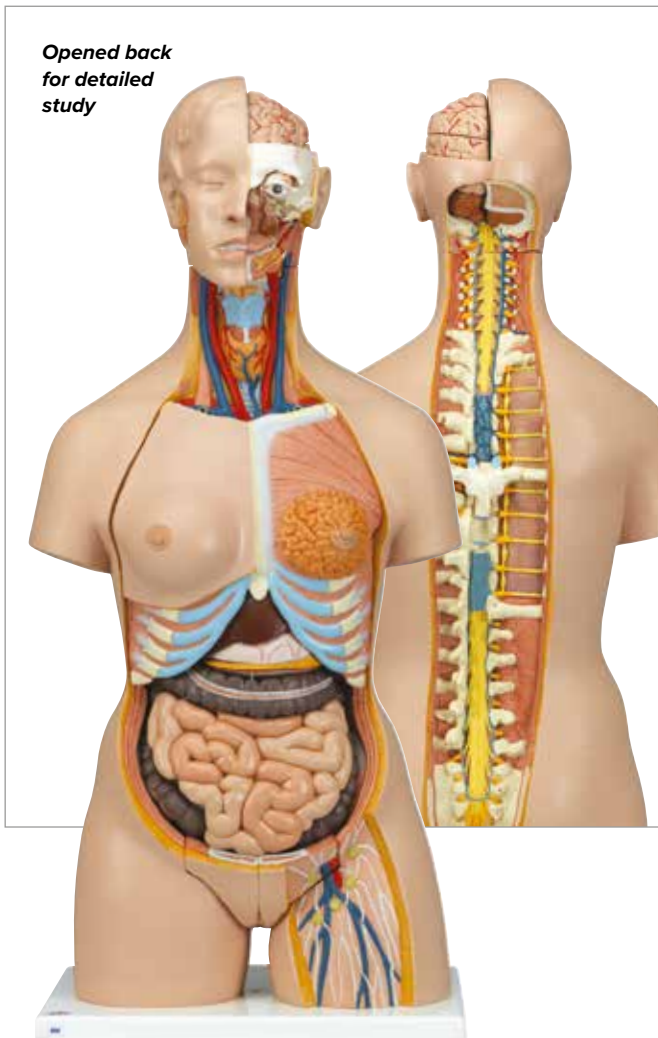

**Opened back  
for detailed  
study**

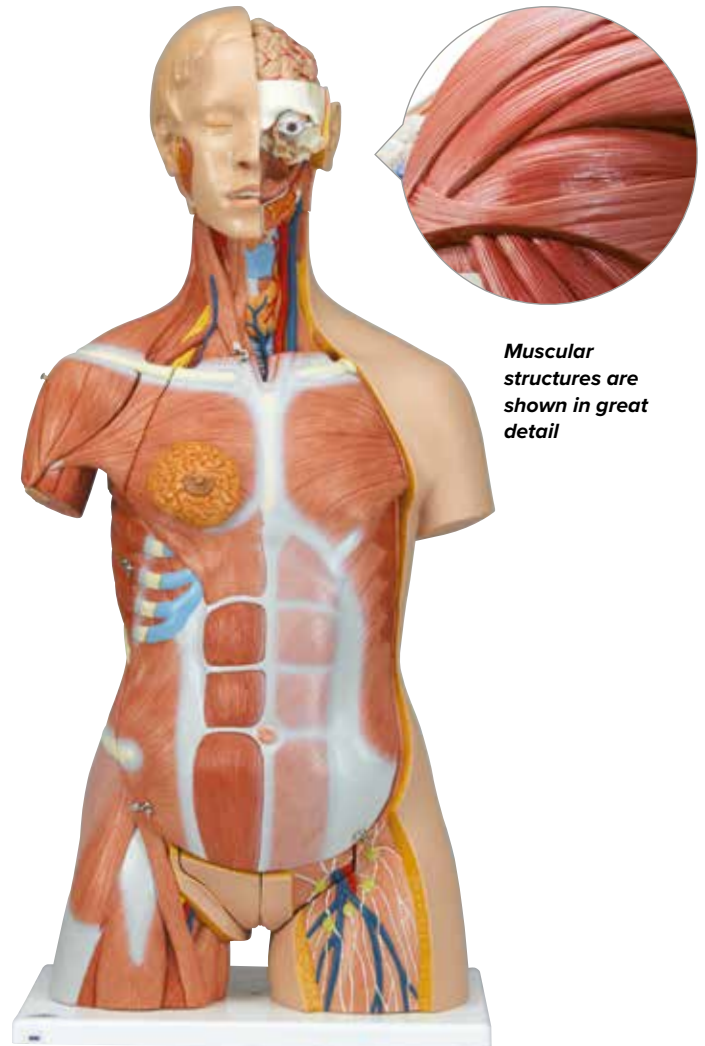

**Muscular  
structures are  
shown in great  
detail**

### 3B SMART ANATOMY

#### Dual Sex Torso with Opened Back, 28-part

This life-size human torso model comes complete with removable male and female genital inserts, opened neck and back section to study vertebrae, intervertebral discs, spinal cord, spinal nerves, vertebral arteries, and a deluxe head with a 4-part brain.

**The following parts and organs can be removed for detailed study:**

- 7<sup>th</sup> thoracic vertebra
- Female chest wall
- 6-part head (incl. 4-part brain)
- Female breast covering
- 2 lungs
- 2-part heart
- 2-part stomach
- Liver with gallbladder
- 4-part intestinal tract
- Front half of kidney
- 4-part male genital insert
- 3-part female genital insert with fetus

Comes complete with the 3B Scientific® Torso Guide, delivered on sturdy base. Light skin.

87 x 38 x 25 cm; 7.6 kg

**M-1000200**

### 3B SMART ANATOMY

#### Dual Sex Muscle Torso, 31-part

This life-size torso depicts both the superficial and deep muscles in great detail. The two main muscles, the deltoid and gluteus maximus can easily be removed for closer studies. You can also study the vertebrae, the spinal cord, spinal nerves and vertebral arteries, exchange the male and female genital inserts, discover the internal structures of the brain and much more.

**The following parts can be removed:**

- 6-part head
- Chest and abdominal wall with muscles
- 7<sup>th</sup> thoracic vertebra
- Female mammary gland
- Gluteus maximus and deltoid muscle
- 2 lungs
- 2-part heart
- 2-part stomach
- Liver with gallbladder
- 4-part intestinal tract
- Front half of kidney
- 3-part female genital insert with fetus
- 4-part male genital insert

Supplied with the 3B Scientific® Torso Guide, mounted on sturdy base. Light skin.

87 x 38 x 25 cm; 8.5 kg

**M-1000203**

## ► LIFE-SIZE TORSO

### 3B SMART ANATOMY

#### Dual Sex Torso with Muscle Arm, 33-part

A worldwide unique feature of this life-size torso is the removable 6-part muscle arm. This top of the line model fully represents the anatomy of the complete human upper body. Its great detail makes it especially suitable for the high levels of medical education. The right half shows the skin, the left half the superficial and deeper muscles with nerves, vessels and bony structures. The versatility of this aesthetically designed model is rounded off by the exact representation of the internal organs.

*The following parts can easily be removed for closer study:*

- 2-part head
- Brain half
- Sternocleidomastoideus muscle
- 6-part muscle arm (removable Muscles: deltoid, biceps brachii, triceps brachii, palmaris longus with flexor carpi radialis, brachioradialis with extensor carpi radialis)
- Upper leg stump
- Chest/abdominal wall with detachable mammary gland
- Torso body
- 2 lungs
- 2-part heart
- Liver with gallbladder
- 2-part stomach
- Kidney half
- 4-part intestinal tract
- 3-part female genital insert with fetus
- 4-part male genital insert

Hand-painted for great detail and realistic colors, delivered on sturdy base. Includes the 3B Scientific® Torso Guide. Light skin.

90 cm; 22.8 kg

**M-1000205**

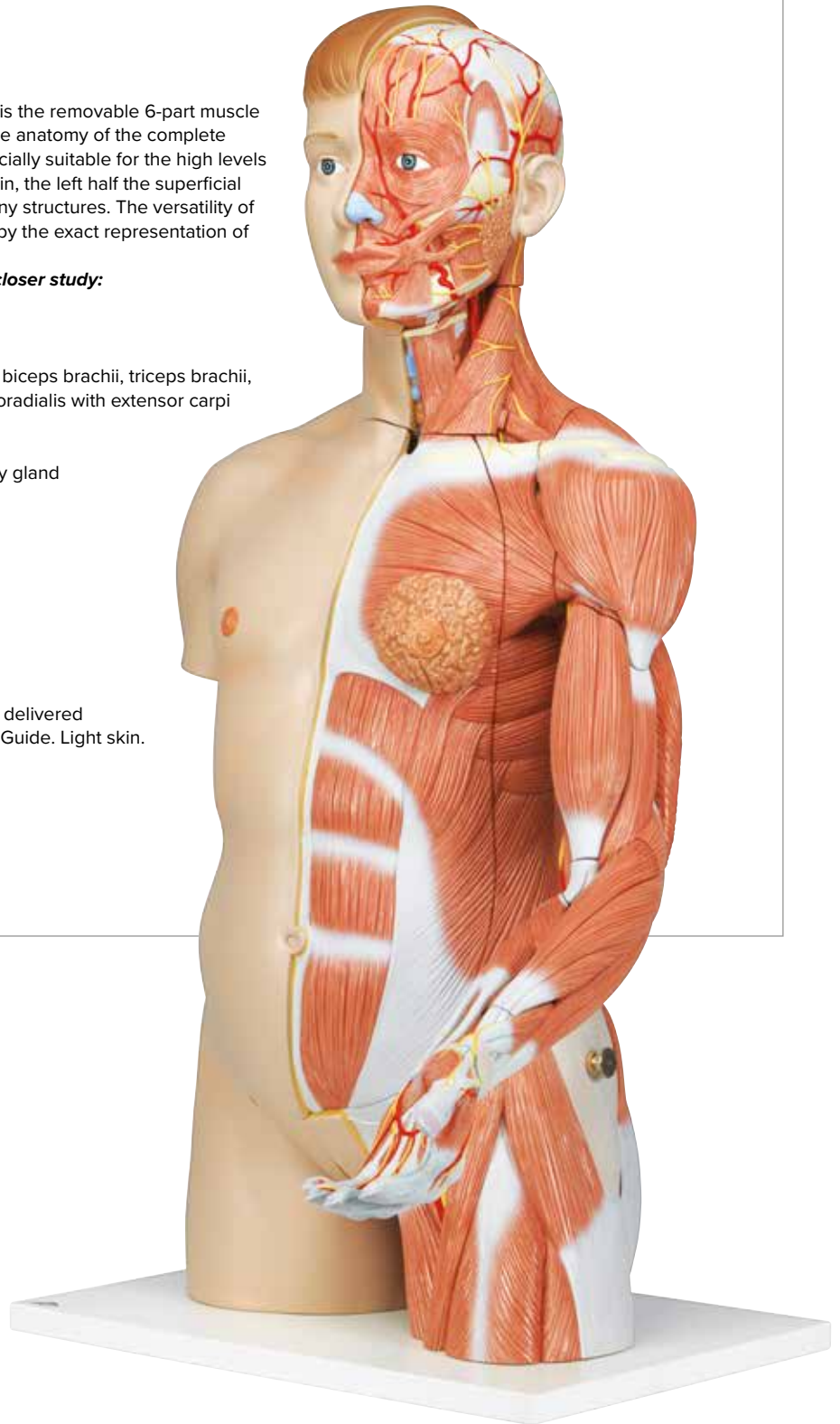

### 3B SMART ANATOMY

#### Asian Dual Sex Torso with muscular arm, 33-part

This life-size human torso models comes with all features of the M-1000205 Dual Sex Torso with Muscle Arm, but in Asian appearance.

90 cm; 22.8 kg

**M-1000204**



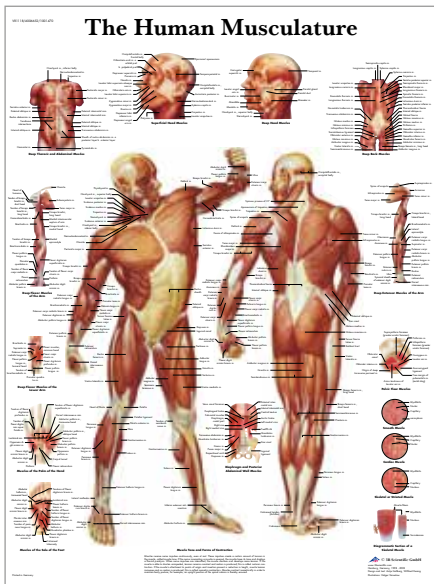

**The Human Musculature**  
**Laminated** M-1001470  
**Paper Version** M-4006652



**3B SMART ANATOMY**  
**Life-Size Muscle Torso, 27-part**

This life-size muscle torso shows the deep and superficial muscles in great anatomical detail. Its anatomical precision and realism make it an outstanding tool for demonstration even in large lecture halls.

***For detailed study and to reveal inner structures, the following pieces can be removed easily:***

- Skull cap
- 6-part brain
- Eyeball with optic nerve
- Chest/abdominal wall
- 2-part larynx
- 2 lungs
- 2-part heart
- Diaphragm
- 2-part stomach
- Liver with gallbladder
- Complete intestinal tract with appendix
- Front half of kidney
- Half urinary bladder
- 4 muscles

Delivered on sturdy base.

95 x 60 x 35 cm; 14 kg

**M-1001236**

➤ YOU WILL FIND A LEARNING CARD FOR EVERY DISC INSIDE THE PRODUCT MANUAL.



*Each disc can be shifted horizontally for closer study from any angle*

### 3B SMART ANATOMY

#### MRI Torso, 15 Transverse Sections

This unique MRI torso is horizontally sectioned into 15 slices, giving a distinctive view of human anatomy. The topographical relationships of the torso are represented as colored reliefs on the individual sectional planes. For a closer study of the internal anatomy of the torso, each disc can be shifted horizontally and rotated around its sagittal axis. Each disc within the MRI torso can be individually removed. The results are a brand new understanding of human anatomy that is both interesting and engaging for students. This MRI torso is a great addition to any medical classroom!

130 x 40 x 35 cm; 19 kg

**M-1001237**

#### Heavy Duty Protective Cover for Torso

Protect your investment with this heavy duty protective cover for your torso models. Suitable for all full-size torsos. Zippered with reinforced easy-carry handle. Black.

**M-1020762**



## TORSO COMPARISON GUIDE

Item No.	M-1000186	M-1000190	M-1000188	M-1000193	M-1000192
Page	222	222	223	223	223
Individual Parts	12	14	16	18	21
Open Back, revealing spine	–	–	–	✓	✓
Head can be disassembled into	2-part	3-part	3-part	6-part	6-part
Lung can be opened to reveal internal anatomy	✓	✓	✓	✓	✓
Rib Cage shown	–	–	✓	–	✓
Heart can be disassembled into	2-part	2-part	2-part	2-part	2-part
Stomach can be disassembled into	1-part	1-part	1-part	1-part	2-part
Liver / Gallbladder can be taken out	✓	✓	✓	✓	✓
Intestinal Tract can be disassembled into	2-part	2-part	4-part	2-part	4-part
Half Kidney can be opened to reveal internal anatomy	✓	✓	✓	✓	✓
Half Urinary Bladder can be opened to reveal internal anatomy	–	✓	✓	✓	✓
Muscular Arm included	–	–	–	–	–
Female Breast Covering can be taken apart	–	–	–	–	–
Gender Neutral	✓	✓	✓	✓	✓
Dual Sex	–	–	–	–	–
Male Genitals can be disassembled into	–	–	–	–	–
Female Genitals can be disassembled into	–	–	–	–	–
Skin Tone	Light	Light	Light	Light	Light
Includes 3B Scientific® Torso Guide	✓	✓	✓	✓	✓
Life-Size	✓	✓	✓	✓	✓
<b>3B SMART ANATOMY</b>	✓	✓	✓	✓	✓



## LOOKING FOR A SMALLER ALTERNATIVE FOR YOUR DESK?

### 3B SMART ANATOMY

#### Mini-Torso, 12-part

At approximately half life-size, this mini human torso model still shows great detail!

**The following parts can be removed:**

- 2-head halves
- Brain half
- 2 lungs
- 2-part heart
- Stomach
- Liver with gallbladder
- 2-part intestinal tract

If you want quality on a budget this mini torso model is for you! All parts are numbered and identified in the product manual.

54 x 24 x 18 cm; 1.89 kg

**M-1000195**

#### 3B Scientific® Torso Guide (not shown)

Already included with most torso model purchases.

- Brilliantly colored pictures of each part of the torso, explaining even the smallest structures
- Includes teaching tips to create even more interesting lessons
- Complete in 7 different languages (Latin, English, German, Spanish, Portuguese, French, Japanese)

Includes CD-ROM to assist in creating tests or preparing lessons

**M-1000183**

#### 3B Scientific® Torso-Classroom Set (not shown)

Includes 33 brilliant overhead-transparencies with colored pictures of each part of the torso.

**M-1000184**

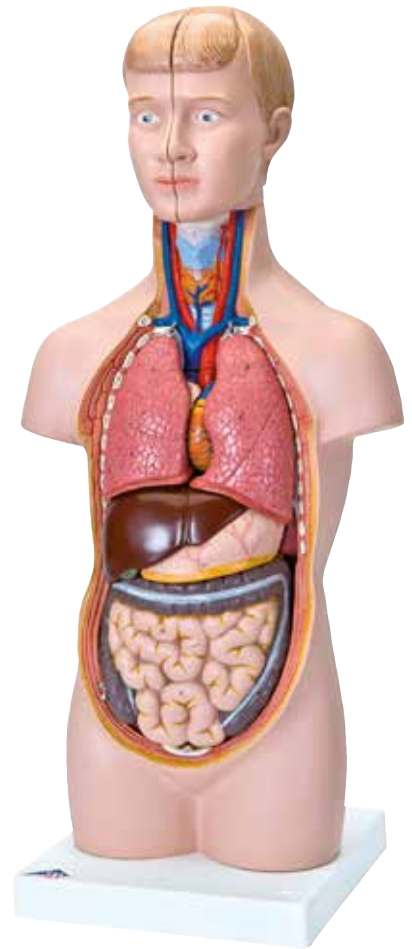

PLEASE SEE 3BSCIENTIFIC.COM FOR MORE DETAILS

M-1000196	M-1000197	M-1000199	M-1000200	M-1000202	M-1000203	M-1000204	M-1000205	M-1000195
224	224	224	225	224	225	226	226	229
24	20	18	28	24	31	33	33	12
-	-	-	✓	-	✓	-	-	-
3-part	2-part	1-part	6-part	3-part	6-part	3-part	3-part	3-part
✓	✓	✓	✓	✓	✓	✓	✓	✓
✓	✓	✓	✓	✓	✓	✓	✓	-
2-part	2-part	2-part	2-part	2-part	2-part	2-part	2-part	2-part
2-part	1-part	1-part	2-part	2-part	2-part	2-part	2-part	1-part
✓	✓	✓	✓	✓	✓	✓	✓	✓
4-part	2-part	2-part	4-part	4-part	4-part	4-part	4-part	2-part
✓	✓	✓	✓	✓	✓	✓	✓	-
-	-	-	-	-	-	-	-	-
-	-	-	-	-	-	6-part	6-part	-
1-part	1-part	1-part	1-part	1-part	2-part	2-part	2-part	-
-	-	-	-	-	-	-	-	✓
✓	✓	✓	✓	✓	✓	✓	✓	-
4-part	4-part	4-part	4-part	4-part	4-part	4-part	4-part	-
3-part	3-part	3-part	3-part	3-part	3-part	3-part	3-part	-
Light	Light	Asian	Light	Dark	Light	Asian	Light	Light
✓	✓	✓	✓	✓	✓	✓	✓	-
✓	✓	✓	✓	✓	✓	✓	✓	1/2
✓	✓	✓	✓	✓	✓	✓	✓	✓

# SKIN MODELS



SCAN THE QR CODE ON P. 174 FOR A FREE 3B SMART ANATOMY DEMO VERSION.

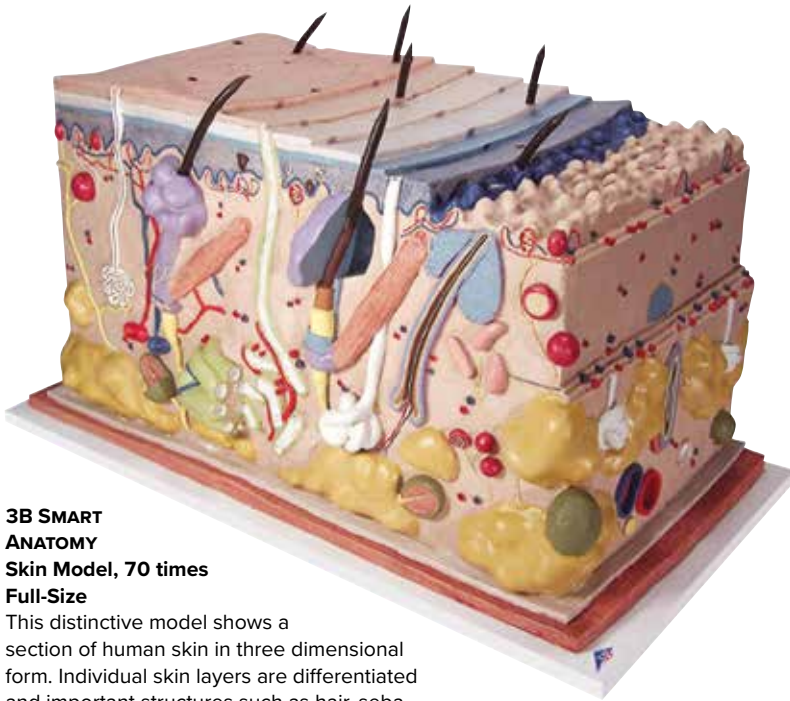

**3B SMART ANATOMY**  
**Skin Model, 70 times Full-Size**

This distinctive model shows a section of human skin in three dimensional form. Individual skin layers are differentiated and important structures such as hair, sebaceous and sweat glands, receptors, nerves, erector pili muscles and vessels are shown in great detail.

Mounted on baseboard.

44 x 24 x 23 cm; 3.6 kg

**M-1000291**

**3B SMART ANATOMY**  
**Skin Section, 40 times Full-Size**

The two halves of this relief model show the three layers of hairy and hairless skin in order to make the differences clear. Detailed with hair follicles, sebaceous glands, sweat glands, receptor, nerves, erector pili muscles and vessels. Mounted on a base.

24 x 15 x 3.5 cm; 0.2 kg

**M-1000290**

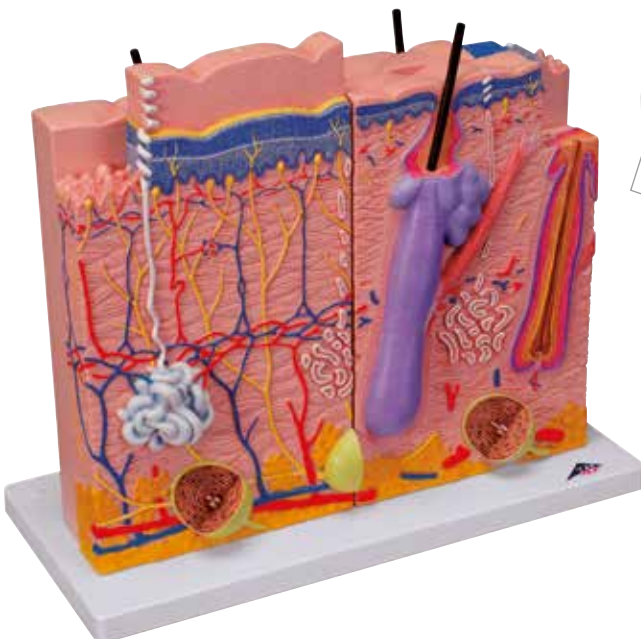
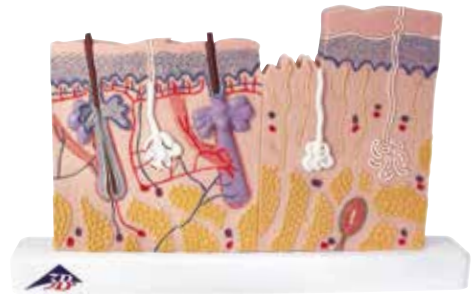

➤ 3 MODELS IN 1!

**3B SMART ANATOMY**  
**Skin Model, 3-part**

The skin is shown 80 times magnified, so even the smallest structures can be seen in detail. It can be taken apart easily thanks to magnetic connections for better demonstration, and represents the three most important sections of skin:

- Palm of the hand
- Back of the hand
- Scalp

34 x 39 x 15.5 cm; 2.05 kg

**M-1000294**





**3B SMART ANATOMY**  
**Skin, Hair and Nail Microscopic Structures**

This model shows the microscopic structure of the skin in great detail. Both hairless and hairy skin structure are shown as well as the different cell layers of the skin, embedded sweat glands, touch receptors, blood vessels, nerves, erector pili muscle, and a hair follicle. Additionally, it includes a section of nail depicting the nail plate, bed, and root, as well as a representation of a hair root with all of its cellular layers.

10 x 12.5 x 14 cm; 0.35 kg  
**M-1000292**

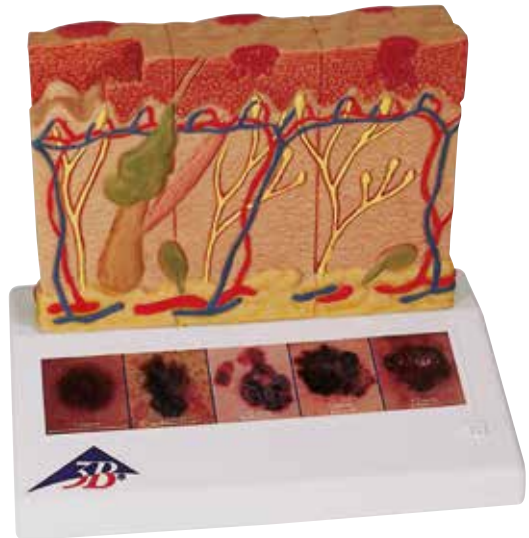

**3B SMART ANATOMY**  
**Skin Cancer Model**

In the top view of the skin cancer model, the individual stages of externally visible skin changes are shown, allowing for an assessment according to the ABCDE criteria. The sides of the skin cancer model show the various levels of invasion into the skin layers according to Clark (I-V) and the tumor thickness according to Breslow (in mm). Five original color illustrations on the base of the skin cancer model show various types of malignant melanomas. Comes mounted on a base.

14 x 10 x 11.5 cm; 0.2 kg  
**M-1000293**



**3B SMART ANATOMY**  
**Skin Section, 70 times Life-Size**

*This relief model shows a section through the three layers of the hair-covered skin of the head:*

- Sweat glands
- Vessels
- Receptors
- Nerves
- Representation of hair
- Follicles with sebaceous glands

Delivered on base.  
 26 x 33 x 5 cm; 1 kg  
**M-1000289**

**Skin Acne Model, 2-Sided**  
 Enlarged two-sided skin cross-section model. The “acne” side displays three conditions: whitehead, black-head and pustule/cyst. The reverse side illustrates normal skin anatomy.  
 15.2 x 5.7 x 10.2 cm  
**M-1019568**

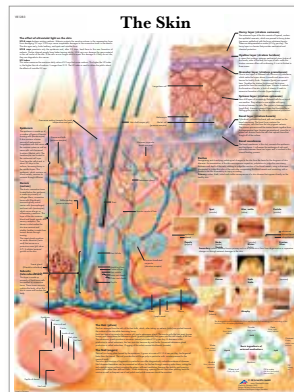

**3B Scientific®**  
**Poster – The Skin**

The anatomy of the human skin, including all skin layers, as well as some common skin pathologies are displayed. Laminated. 50 x 67 cm  
**M-1001512**

# HEAD & BRAIN MODELS



SCAN THE QR CODE ON P. 174 FOR A FREE  
3B SMART ANATOMY DEMO VERSION.

+

You can depend on 3B Scientific® anatomical models:

- + Carefully cast and hand-painted by skilled craftsmen
- + Manufactured to precise anatomical details
- + Extremely durable thanks to high quality material
- + Non-toxic for everyday hands-on use

## 3B SMART ANATOMY

### Half Head with Musculature

This high quality model represents the outer, superficial and the internal (median section) structures of head and neck. The half head with musculature is delivered on removable stand for easy display in a classroom or doctor's office. Presents the important anatomical structures.

22 x 18 x 46 cm; 1.1 kg

**M-1000221**



## 3B SMART ANATOMY

### A. Median Section of the Head

Relief median section of the head shows all relevant structures of the human head in great detail. Delivered on a baseboard.

26 x 33 x 5 cm; 1 kg

**M-1000219**

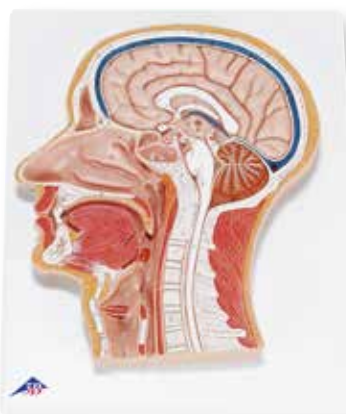

## 3B SMART ANATOMY

### B. Head Section Model

Frontal section through the human paranasal sinuses covered with mucous membrane. Signs of sinusitis (paranasal sinus inflammation) on the right, with normal ventilation of the left side.

Delivered on baseboard.

41 x 31 x 5 cm; 1.45 kg

**M-1012789**

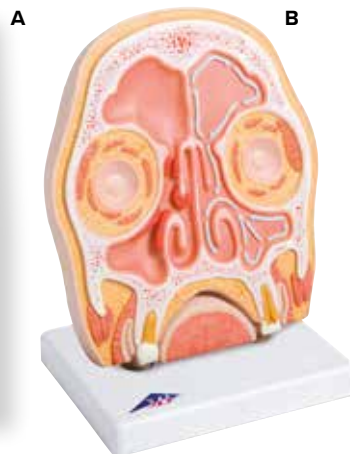

## 3B SMART ANATOMY

### C. Median and Frontal Section of the Head

The two relief models show the median and frontal section of the head. The two views of this high quality model show all important anatomical structures of the head in full detail. They include cross sections of the brain, spinal cord, and sinuses of the human head.

Delivered on baseboard.

41 x 31 x 5 cm; 1.45 kg

**M-1000220**



➤ GREAT TOOLS FOR EDUCATION ON THE HUMAN NERVOUS SYSTEM AND ANATOMY OF THE BRAIN!

**3B SMART ANATOMY**

**Head Musculature**

This head model represents the superficial musculature of head and neck, showing:

- Parotid gland
- Submandibular gland
- Deep musculature
- Lower jaw partially exposed

Mounted on base.

24 x 18 x 24 cm; 1.2 kg

**M-1001239**

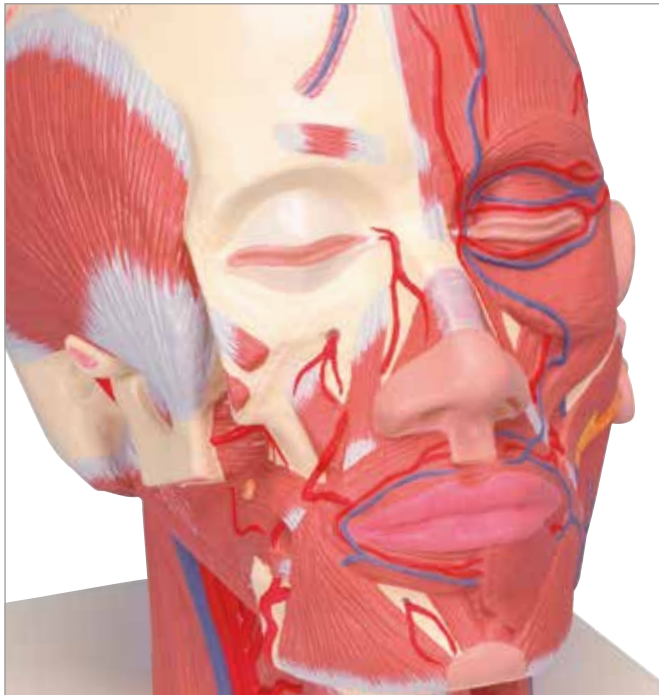
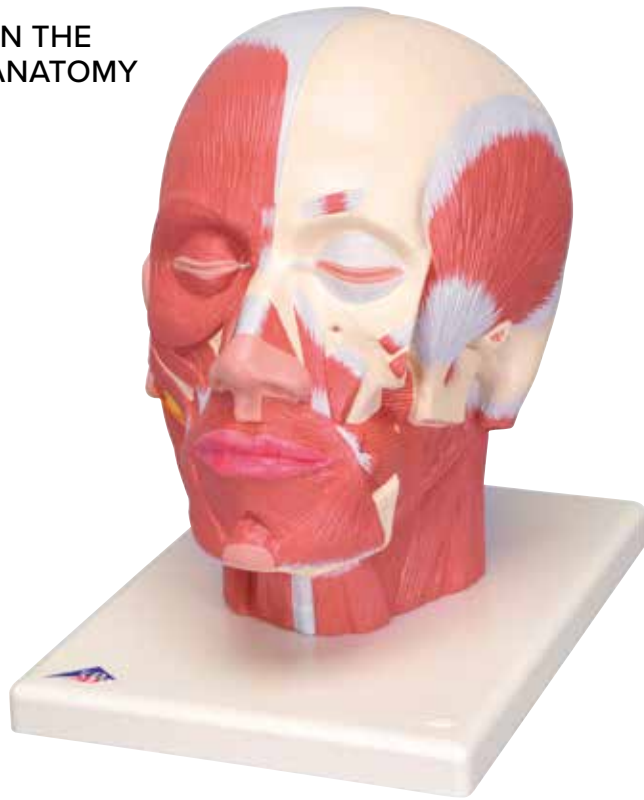

**3B SMART ANATOMY**

**Head Musculature with Blood Vessels**

In addition to the features of the classic head musculature model, this version also shows the blood vessels on the head. Mounted on base.

24 x 18 x 24 cm; 1.2 kg

**M-1001240**



**3B SMART ANATOMY**

**Head Musculature with Nerves**

In addition to the classic head musculature model, this version also shows the nerves on the head. Mounted on base.

24 x 18 x 24 cm; 1.2 kg

**M-1008543**



*Includes 3-part brain and numbered details!*

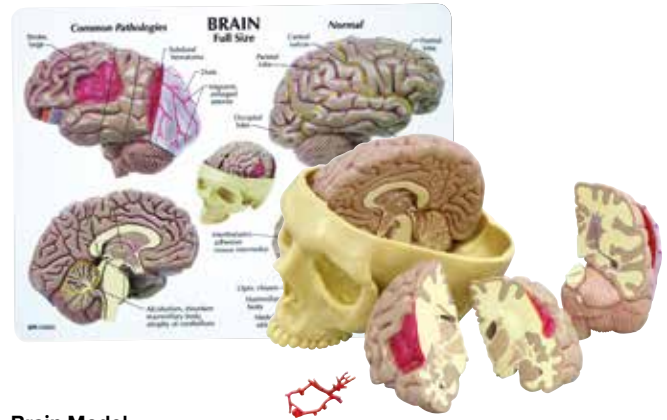

#### Brain Model

Full size segmented brain model features half normal side and three-piece sectioned pathology half, as well as Circle of Willis with aneurism. The brain, which sits inside a partial skull, features the following pathologies which are also illustrated on a two-sided education card: alcoholism, Alzheimer's, aneurism, depression related tumor, seizure related tumor, migraine, multiple sclerosis, Parkinson's disease, stroke, and subdural hematoma.

12.7 x 17.1 x 12.7 cm

**M-1019542**

#### 3B SMART ANATOMY

##### Head and Neck Musculature, 5-part

This model shows a realistic representation of the superficial musculature and deep muscles, nerves and vessels of a human head and neck in life-size. It can easily be disassembled into skull cap and 3-part brain. Anatomical details are painted on the model for easy identification with the help of the product manual. On base.

36 x 18 x 18 cm; 1.8 kg

**M-1000214**



#### 3B SMART ANATOMY

##### Head with Neck, 4-part

This life-size and detailed head model is midsagittally sectioned, and while the right side shows a realistic looking face, the left side reveals the muscles, nerves, vessels, and bony structures of the head. For in depth study, the model contains a removable brain half. The neck detachable and sectioned both horizontally and diagonally. Caucasian appearance, supplied on baseboard.

26 cm; 2.2 kg

**M-1000216**



#### 3B SMART ANATOMY

##### Asian Head with Neck, 4-part

Same features and details like the M-1000216 but with Asian appearance. Supplied on baseboard.

26 cm; 2.2 kg

**M-1000215**



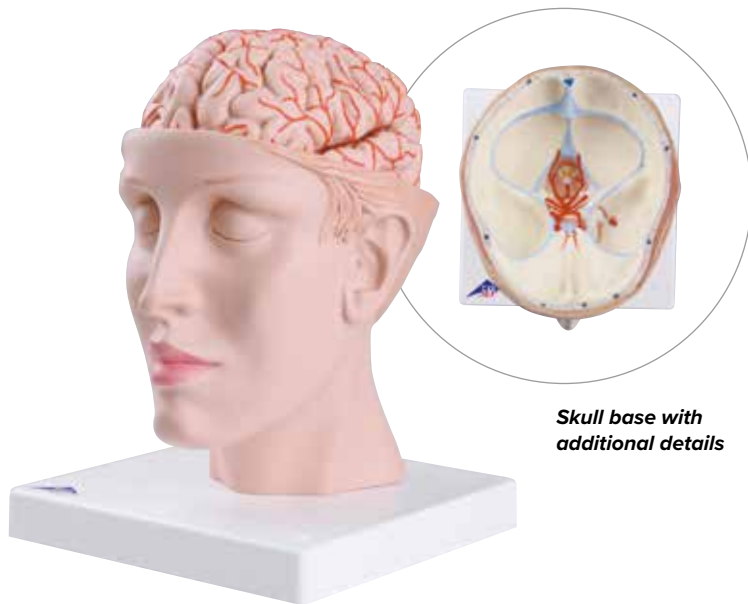

**Skull base with additional details**



### 3B SMART ANATOMY

#### Brain with Arteries on Base of Head, 8-part

This deluxe brain comes with an opened head to allow detailed study of the brain's position in the skull. The head is horizontally divided above the skull base. The brain is divided medially, with a removable basilar artery.

**Both halves can be divided into:**

- Frontal parietal lobes
- Temporal with occipital lobes
- Half of brain stem
- Half of cerebellum

On base.

15 x 15 x 23 cm; 1.6 kg

**M-1017869**

### 3B SMART ANATOMY

#### Brain with Arteries, 9-part

This brain model is a great tool for education on the human nervous system and anatomy of the brain. Delivered on a removable base for easy display in the classroom.

15 x 14 x 16 cm; 0.9 kg

**M-1017868**

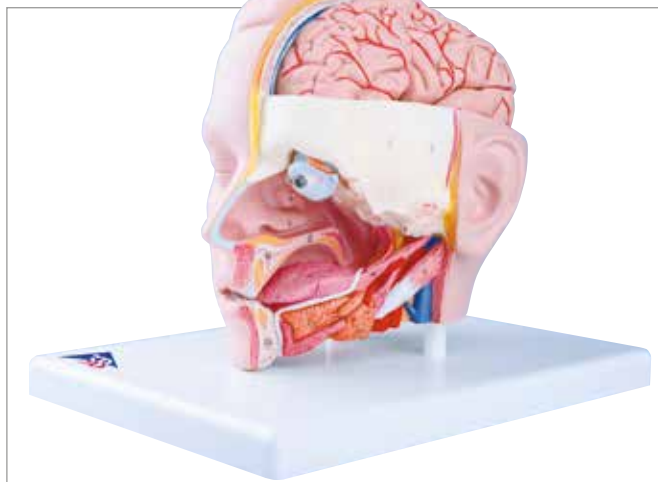

### 3B SMART ANATOMY

#### Head Model, 6-part

This head model meets the highest standard requirements of medical education! It is life-size, comes with 6 removable parts and is mounted on a base. Included is a removable 4-part brain half with arteries. The eyeball with optic nerve is also removable for detailed study. One side exposes the nose, mouth cavity, pharynx, occiput, and skull base.

19 x 23 x 22 cm; 1 kg

**M-1000217**

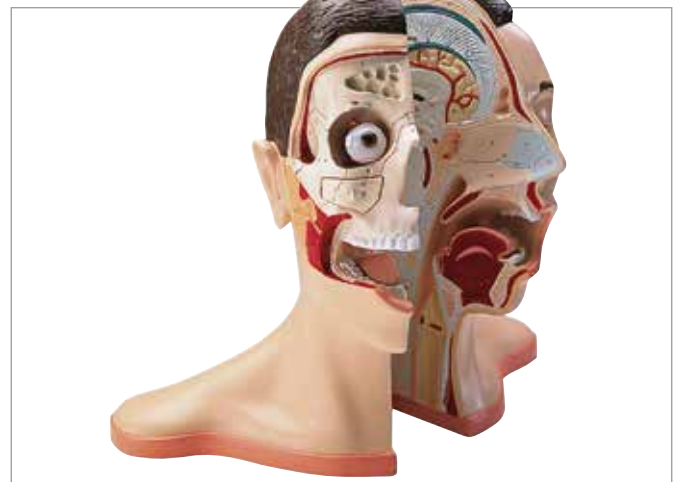

### 3B SMART ANATOMY

#### Head and Neck, 5-part

This model shows a medially divided representation of the head. The skin and facial muscles of the right outer half are removed to show the deeper structures. The eyeball, the bone cover over the sinus maxillaries and the right tongue half are removable for detailed study. The parts are differentiated in color.

38 x 36 x 25 cm; 3 kg

**M-1005536**



3B Scientific® brain models have been cast from real specimens and accurately represent even the finest structural details.

- + Magnetic connections for easy demonstrations
- + Highest quality material for long lasting models
- + Hand-painted and manufactured to precise anatomical detail



To see additional images and to zoom in on details, please visit [3bscientific.com](http://3bscientific.com)



**Compatible with the following skull models:**

- M-1020159, M-1020163,
  - M-1020164, -M-1020165,
  - M-1020166, M-1020167,
  - M-1020168, M-1020169
- (see pages 210-215)



**3B SMART ANATOMY**

**Classic Brain, 5-part**

This midsagittally sectioned model is an original anatomical cast of a real human brain.

**The components of the brain's left half are:**

- Frontal and parietal lobe
- Temporal and occipital lobe
- Encephalic trunk
- Cerebellum

Delivered on removable stand.

13 x 14 x 17.5 cm; 0.9 kg

**M-1000226**

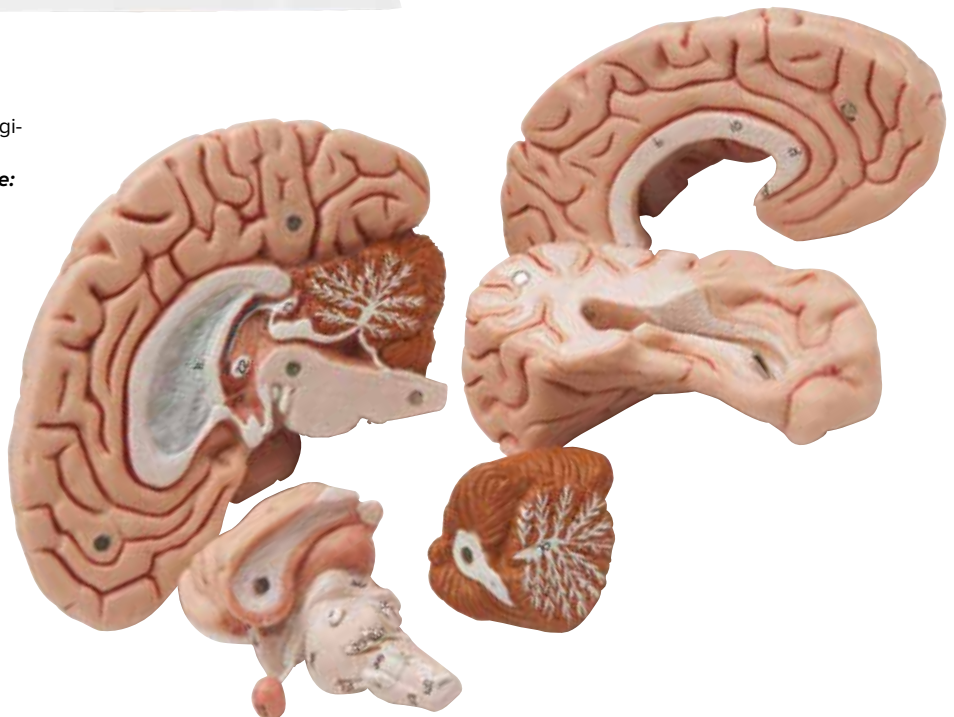

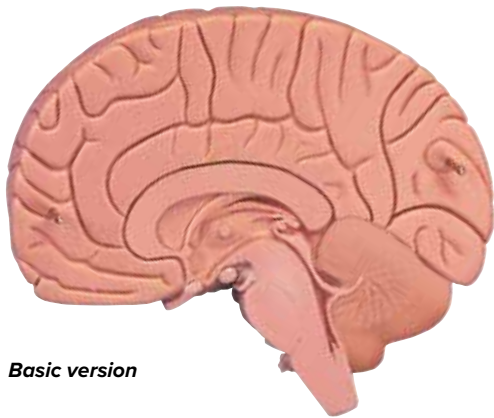

**Basic version**

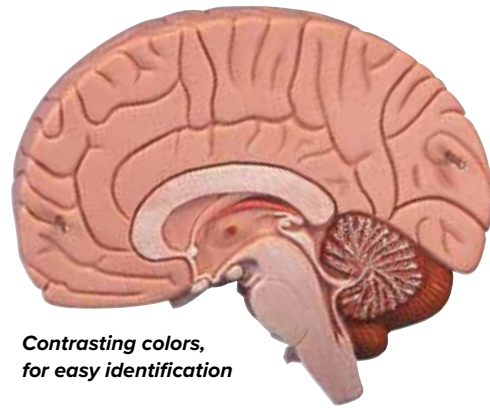

**Contrasting colors,  
for easy identification**

**3B SMART ANATOMY**

**Introductory Brain Model, 2-part**

This basic brain is medially divided, anatomically accurate, and life-size! The structures of the brain are shown in one color, providing an introduction to the human nervous system and anatomy of the brain. Structures of the brain are not labeled or numbered. This introductory brain is delivered on removable base.

15 x 14 x 17.5 cm; 0.7 kg

**M-1000223**

**3B SMART ANATOMY**

**Brain Model, 2-part**

Contrasting colors are used to indicate various anatomic structures in this medially divided human brain, making this high quality model perfect for beginning anatomy studies of the human brain. On removable base.

15 x 14 x 17.5 cm; 0.7 kg

**M-1000222**

**3B SMART ANATOMY**

**Brain Model, 4-part**

This 4-part brain is medially divided. All structures of the brain are hand-painted, numbered and identified in a product manual.

**The brain's right half can be disassembled into:**

- Frontal with parietal lobes
- Brain stem with temporal and occipital lobes
- Half of cerebellum

Delivered on a removable base.

14 x 14 x 17.5 cm; 0.9 kg

**M-1000224**



**8 parts, for  
detailed studies**

**3B SMART ANATOMY**

**Brain Model, 8-part**

A very detailed model of the human brain which is medially divided.

**Both halves of this brain can be disassembled into:**

- Frontal with parietal lobes
- Temporal with occipital lobes
- Half of brain stem
- Half of cerebellum

Delivered on a removable base.

14 x 14 x 17.5 cm; 0.9 kg

**M-1000225**

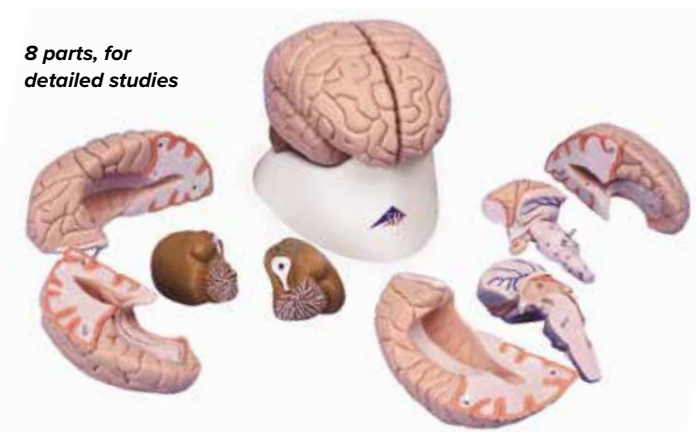



### 3B SMART ANATOMY

#### Neuro-Anatomical Brain, 8-part

This deluxe brain is medially divided. On the right half of this brain, you will find a systematically colored grouping and representation of the cerebral lobe.

#### **The left half of the brain shows:**

- Pre- and post-central region
- Broca and Wernicke areas
- Heschl's gyrus
- Brain nerves
- Ventricles

#### **Both halves of this brain can easily be disassembled into:**

- Frontal with parietal lobes
- Temporal with occipital lobes
- Half of brain stem
- Half of cerebellum

Delivered on a removable base.

14 x 14 x 17.5 cm; 0.95 kg

**M-1000228**



*Take the model apart to see more details*

### 3B SMART ANATOMY

#### Brain Section Model

An enlarged and very detailed section through the right half of the brain, including a portion of the skull. The pia mater has been removed. This model is double sided and finely colored. One surface is on the median line, including a section of the falx cerebri. A sagittal cut on the reverse side exposes the lateral ventricle. There are 49 references on the model, identified in English in the product manual. Mounted on a stand. 25 x 18 x 12 cm; 0.9 kg

**M-1005113**

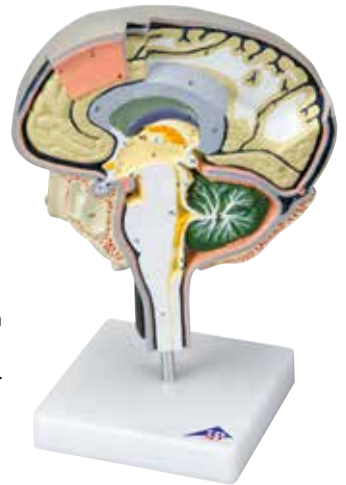

### 3B SMART ANATOMY

#### Cerebrospinal Fluid Circulation

Enlarged, detailed model of a section through the right half of the brain showing the cut pia mater, arachnoid and dura mater. The model has the cerebrospinal fluid areas clearly identified and the direction of flow indicated by arrows. Bright colors distinguish important features; identified in English in the product manual. Mounted on stand. 25 x 18 x 12 cm; 0.9 kg

**M-1005114**

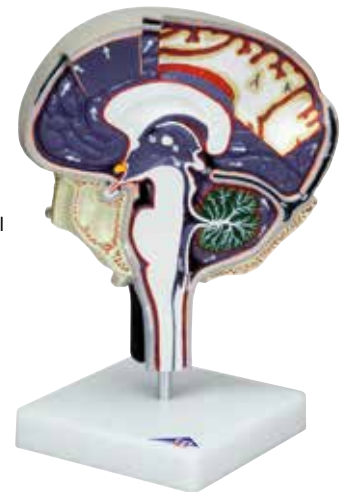

### 3B SMART ANATOMY

#### Brain Ventricle

This model shows both side ventricles of the brain, the 3<sup>rd</sup> and 4<sup>th</sup> ventricle and the Aquaeductus cerebri (Sylvius). The brain ventricles are life-size and the model is delivered on stand.

14 x 11 x 14 cm; 0.6 kg

**M-1001262**



**Giant Functional-Center Brain, 4-part**

This popular brain model reproduces the brain of a right-handed person. It employs contrasting colors and hand-painted captions to identify motor and sensory functional centers. In addition to focusing on the intellectual role of the dominant left brain, and the creative role of the right, the model highlights the emotional, sexual, memory, and learning functions of the limbic system.

- Distinguishment of sensory regions and centers receptive to 20 specific body regions
- Distinguishment of motor centers controlling 19 body regions
- More than 120 hand-numbered features identified in the manual

Delivered on base.  
23 x 20 x 30 cm; 2.38 kg

**M-100555**

**TRUE HANDS-ON EDUCATION WITH THIS OVERSIZED BRAIN MODEL!**

**3B SMART ANATOMY**

**Giant Brain, 2.5 times Full-Size, 14-part**

At 2.5 times life-size this comprehensive brain model is a very useful teaching aid, especially for large groups of students. All structures of the brain and the ventricles are visible through median, frontal, and horizontal divisions. Delivered with a removable base.

- Unbreakable – Natural cast made from durable vinyl
- 14 removable segments secured with pins
- Ideal for 3D study of brain structures

Includes removable base.

34 x 30 x 37 cm; 5.6 kg

**M-1001261**



**3B SMART ANATOMY**

**Rat Brain Comparative Anatomy**

Enlarged roughly six times, and medially sectioned, the rat brain model can be disassembled into two halves. The right half of the color-coded model shows the structures of the cerebrum, cerebellum, and brainstem. The left half is mostly transparent to reveal the left lateral ventricle and hippocampus in the median section. For comparison, a natural cast of a rat brain and a didactic, small-scale illustration of a human brain in median section are shown on the base. Each has the same color coding used for the various regions.

14 x 10 x 16 cm; 0.24 kg

**M-1000230**



# NERVOUS SYSTEM MODELS



SCAN THE QR CODE ON P. 174 FOR A FREE  
3B SMART ANATOMY DEMO VERSION.



*5 times  
Life-Size*

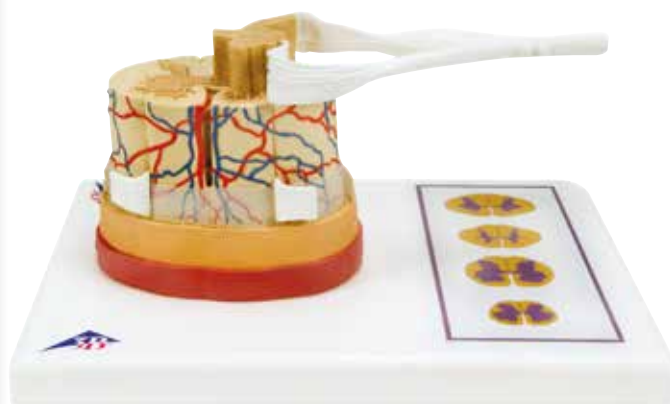

## **3B SMART ANATOMY Spinal Cord Model, 5 times Life-Size**

The model illustrates the composition of the spinal cord with nerve endings. For easier study, the model is 5 times life-size. The spinal cord is formed by a central channel surrounded by “gray matter” with an outer layer of “white matter”. The base of the model features illustrations of the various cross-sections of the spinal cord through the white and gray matter at the neck, torso and lumbar and sacral regions.

Supplied on a base.  
26 x 19 x 13 cm; 0.4 kg

**M-1000238**

## **3B SMART ANATOMY Nervous System, 1/2 Life-Size**

An excellent model to study the structure of the human nervous system. This 3D relief model shows schematic representation of the central and peripheral nervous system, numbered and identified in the manual. Delivered on baseboard.

80 x 33 x 6 cm; 3.5 kg

**M-1000231**



**3B SMART ANATOMY  
Physiology of Nerves Series**

Unique five model series for education about the human nervous system. Interchangeable sections can be assembled to illustrate the features of typical neurons found in vertebrates. All sections depict the neural components in vivid colors and attach magnetically to the illustrated metal base.

**The set contains the following sections, which are also available individually:**

- Neuron Cell Body
- Myelin Sheaths of the CNS
- Schwann Cells of the PNS
- Motor End Plate
- Synapse

68 x 51 x 3 cm; 4.2 kg

**M-1000232**

**INDIVIDUAL SECTIONS:**

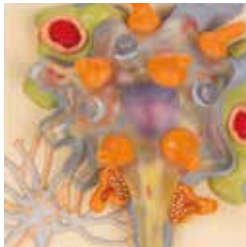

**3B SMART ANATOMY  
Neuron Cell Body**

Typical neuron body with cell organelles.

12.2 x 11.7 x 6.2 cm;  
0.2 kg

**M-1000233**



**3B SMART ANATOMY  
Myelin Sheaths of the CNS**

Glial cells which build the insulating layer around the axons of the central nervous system.

12.2 x 11.7 x 3.6 cm;  
0.2 kg

**M-1000234**



**3B SMART ANATOMY  
Schwann Cells of the PNS**

Schwann cell with sectioned core.

12.2 x 11.7 x 6.2 cm;  
0.2 kg

**M-1000235**



**3B SMART ANATOMY  
Motor End Plate**

Depicts the neuromuscular junction with striated muscle fibre.

12.2 x 11.7 x 6.2 cm;  
0.2 kg

**M-1000236**

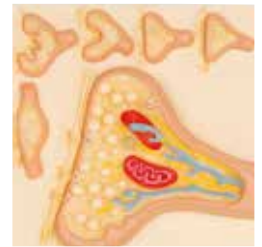

**3B SMART ANATOMY  
Synapse**

Features the endoplasmic reticulum, mitochondria and the membranes of the synaptic gap.

12.2 x 11.7 x 6.2 cm;  
0.2 kg

**M-1000237**

**➤ MAGNIFIED OVER 2,500 TIMES!**

**Motor Neuron Diorama**

This color-coded, 3D reproduction shows a motor nerve cell situated within a milieu of interacting neurons and a skeletal muscle fiber. The membranous envelope is cut away from the neuron to expose the cytological ultrastructure, organelles, and inclusions within the cell body. A section of the axon lifts off to let you view the tightly wound layers of the enveloping myelin sheath and neurolemma, as well as the Schwann cell which formed them. Via a cutaway view, you can observe synaptic vesicles, carrying neurotransmitters, about to stimulate the muscle fibre to action. Mounted on a wooden base.

43 x 20 x 28 cm; 3 kg

**M-1005553**



# EYE MODELS



SCAN THE QR CODE ON P. 174 FOR A FREE 3B SMART ANATOMY DEMO VERSION.



### 3B SMART ANATOMY

#### Eye, 3 times Life-Size, 6-part

Can be disassembled into the following parts:

- Both halves of the sclera with cornea and eye muscle attachments
- Both halves of the choroid with iris and retina
- Eye lens
- Vitreous humor

9 x 9 x 15 cm; 0.1 kg

**M-1000259**



### 3B SMART ANATOMY

#### Eye, 5 times Life-Size, 6-part

This advanced eye model comes on a base, the following parts are removable:

- Upper half of the sclera with cornea and eye muscle attachments
- Both halves of the choroid with iris and retina
- Lens
- Vitreous humor

13 x 14 x 21 cm; 0.6 kg

**M-1000255**



### 3B SMART ANATOMY

#### Eye in Orbit, 5 times Life-Size, 7-part

- Upper half of the sclera with cornea and eye muscle attachments
- Both halves of choroid with iris and retina lens
- Vitreous humor
- Shown in bony orbit

18 x 18 x 20 cm; 1 kg

**M-1000256**



### Eye Model

Oversized normal eye model with cut-away to show inner anatomy, including optic nerve, disc, macula, retina, central retinal artery and vein. Lens and cornea are removable.

12.7 x 7.6 x 10.2 cm

**M-1019533**



### 3B SMART ANATOMY

#### Eye with Eyelid, 5 times Life-Size, 8-part

This larger than life eye model is great for studying the anatomy of the human eye!

#### Features:

- Upper half of the sclera with cornea and eye muscle attachments
- Both halves of choroid with iris and retina
- Eye lens
- Vitreous humor
- Eyelid
- Lachrymal system
- Anatomical features around the eyeball

20 x 18 x 21 cm; 1.2 kg

**M-1000257**



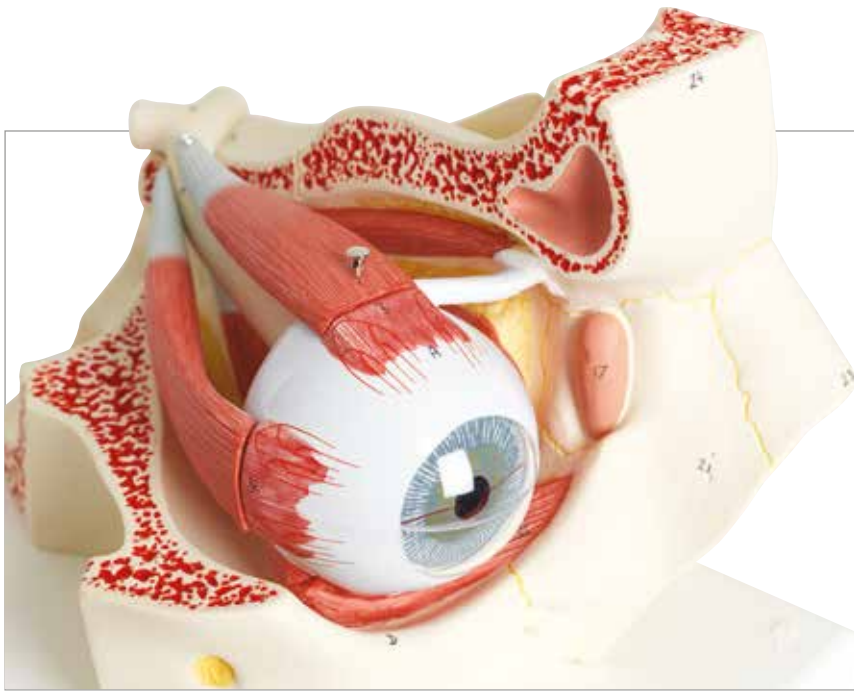

**3B SMART ANATOMY**

**Eye in Orbit, 3 times Life-Size, 7-part**

This large anatomical human eye model shows the optic nerve in its natural position in the bony orbit of the eye (floor and medial wall).

**For closer study, it can be disassembled into:**

- Includes the extraocular muscles
- Both halves of the choroid with iris and retina
- Eye lens
- Vitreous humor
- Bony orbit

18 x 26 x 19 cm; 1.1 kg

**M-1000258**

**3B SMART ANATOMY**

**Eye with Partial Face, 5 times Life-Size, 12-part**

This 3B Scientific® eye model shows the eyeball with optic nerve in its natural position in the bony orbit (floor and medial wall). Additionally, this eye model shows the relation between eye, bones, muscles, and outer structures of the eye.

**Dissects into:**

- Two halves of the sclera
- Optic nerve
- M. rectus superior
- M. rectus lateralis
- Cornea half
- Eye lens
- Lachrymal system
- Vitreous humor
- Tear gland
- Associated structures

33 x 30 x 38 cm; 4.9 kg

**M-1001264**

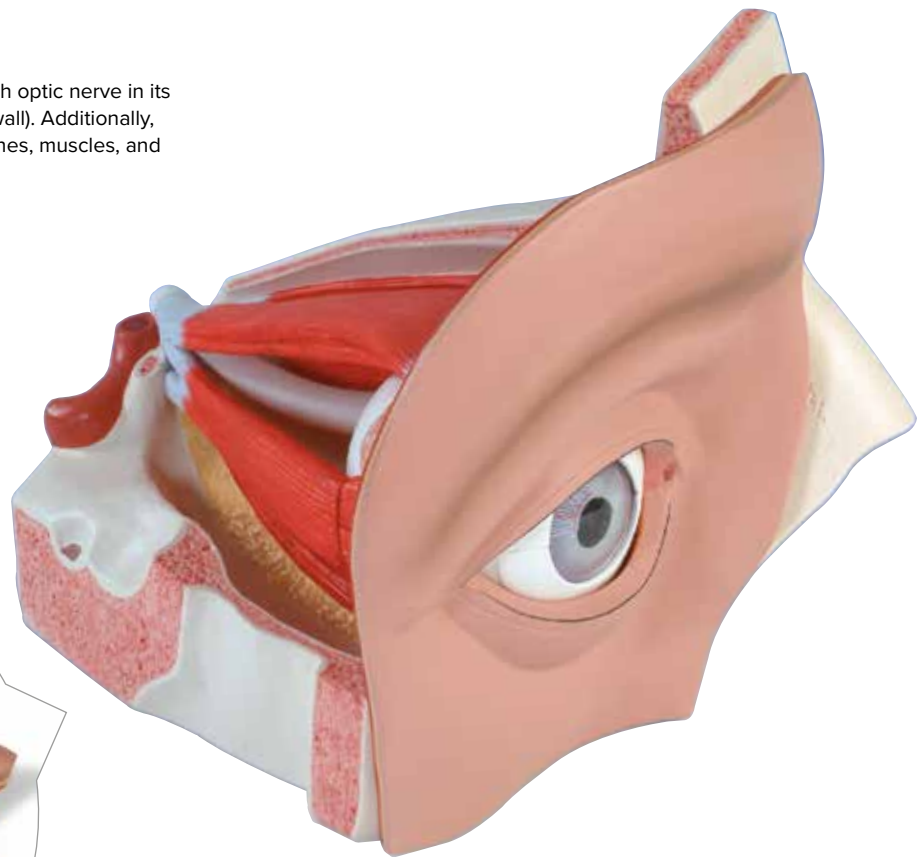

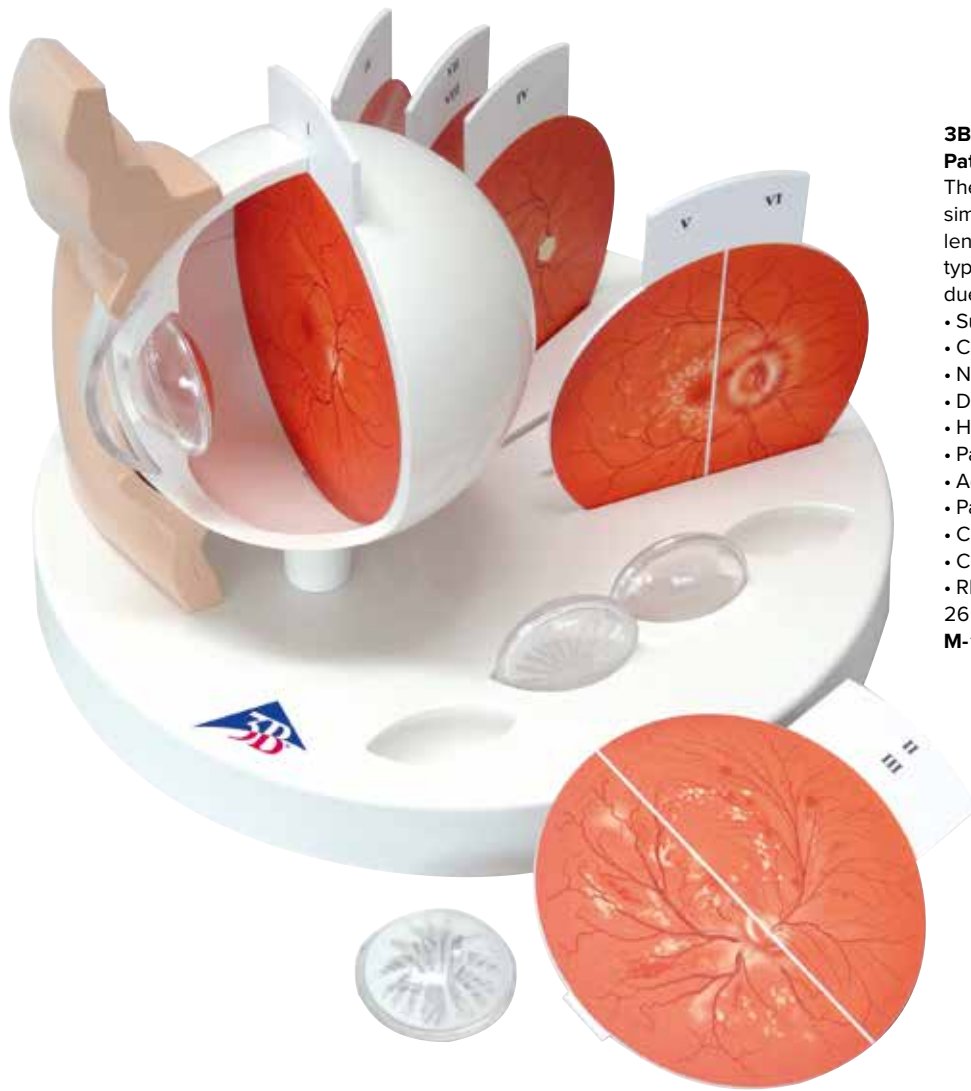

### 3B SMART ANATOMY

#### Pathological Eye, 5 times Life-Size

The easy to use switchable and didactically simplified representations of the retina and lens make it possible to clearly explain the typical changes that occur in a healthy eye due to the following diseases:

- Subcapsular cataract
- Cortical cataract
- Nuclear cataract
- Diabetic retinopathy
- Hypertensive retinopathy
- Papillary changes of glaucoma
- Age-related macular degeneration
- Papilloedema
- Central retinal arterial occlusion
- Central retinal venous occlusion
- Rhegmatogenous retinal detachment

26 x 26 x 21 cm; 0.73 kg

**M-1017230**

*Retina and lens can be switched easily*



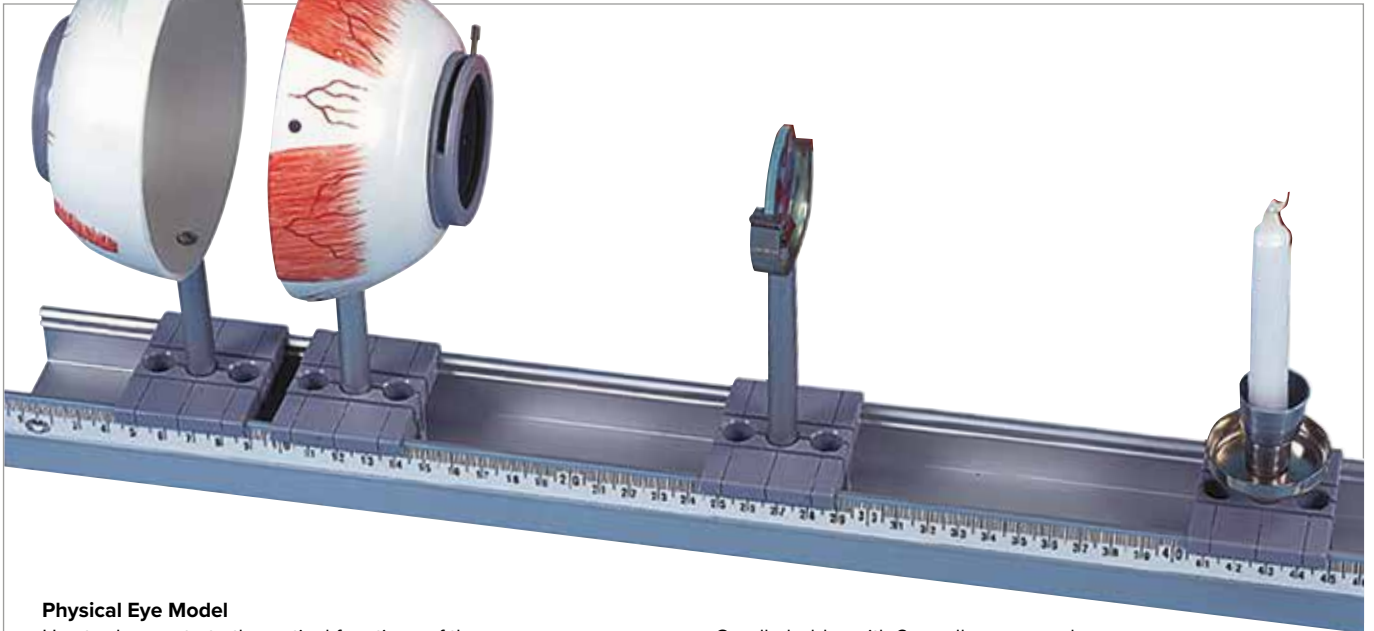

**Physical Eye Model**

Use to demonstrate the optical functions of the eye, e.g. representation of an object on the retina, accommodation, short-sightedness and far-sightedness.

- Half eyeball with adjustable iris diaphragm, lens holder and 2 convex lenses (f = 65 mm and 80 mm), on a rod
- Half eyeball with retina (transparent screen), on a rod
- Lens holder with one concave and one convex corrective lens, on a rod

- Candle holder with 2 candles, on a rod
  - Aluminium rail, 50 cm long, with 4 clamp slides
- Includes case  
49 x 5.5 x 18 cm; 2 kg  
**M-1003806**

*Inner nuclear layer and outer nuclear layer*



**3B SMART ANATOMY  
3B MICROanatomy™ Eye**

The model illustrates the microscopic structure of the retina with choroid and sclera:

- Left block: 850-times enlarged view of retina including supplying vascular layer and parts of the sclera
  - Right block: 3800-times enlarged view of photoreceptors and cells of the pigmented layer
- 25 x 23 x 18.5 cm; 1.2 kg

**M-1000260**



# EAR, NOSE & THROAT MODELS



SCAN THE QR CODE ON P. 174 FOR A FREE  
3B SMART ANATOMY DEMO VERSION



**3B SMART ANATOMY**  
**Desktop Ear Model, 1.5 times Life-Size**

Specifically designed for those on a budget, the model shows the outer, middle, and inner ear with no compromise in quality.

On base.  
14 x 10 x 14.7 cm; 0.35 kg

**M-1000252**



**3B SMART ANATOMY**  
**Ear Model, 3 times Life-Size, 4-part**

At approximately 3 times life-size, the model represents the outer, middle, and inner ear. Removable eardrum with hammer, anvil, and stirrup, as well as 2-part labyrinth with cochlea, and auditory/balance nerve.

On base.  
34 x 16 x 19 cm; 1.25 kg

**M-1000250**



**3B SMART ANATOMY**  
**Ear Model, 5 times Life-Size, 3-part**

This high quality human ear model represents outer, middle and inner ear.

- Removable eardrum with hammer, anvil and stirrup
- 2-part labyrinth with cochlea and auditory/ balance nerve Includes detail of two removable bone sections to close the middle and inner ear

On base.  
25 x 41 x 25 cm; 3 kg

**M-1008553**

## ➤ REMOVABLE PARTS FOR DETAILED STUDY OF THE ANATOMY OF THE HUMAN EAR!

**3B SMART ANATOMY**  
**Ear Model, 3 times Life-Size, 6-part**

This high quality human ear model represents outer, middle and inner ear.

**Includes:**

- Removable eardrum with hammer, anvil and stirrup
- 2-part labyrinth with cochlea and auditory / balance nerve
- The detail of two removable bone sections to close the middle and inner ear.

On base.  
34 x 16 x 19 cm; 1.55 kg

**M-1000251**

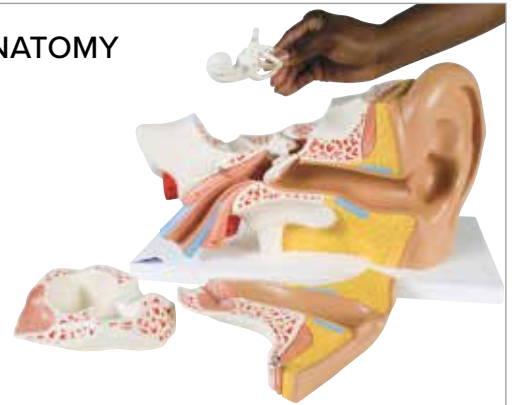

**Clear Ear Model**

The Clear Ear Model is a full size model of human ear is clear to aid viewing of ear canal, tympanic membrane, stapes, incus, malleus and cochlea of the inner ear.

7.9 x 7.6 x 5.8 cm

**M-1019527**

**Ear Model**

This Ear Model is a full size normal model shows semi-circular canals and cochlea of the inner ear, auditory ossicles from the middle ear, tympanic membrane, temporal and tensor tympani muscles.

9.5 x 6.4 x 7 cm

**M-1019526**





**3B SMART ANATOMY**  
**Organ of Corti**

The model shows a three dimensional section through the organ of Corti, the site of the sense of hearing in the inner ear in humans. Special attention has been given to the detailed representation of the individual cellular components and membranes. The overview model in the foreground also shows the exact location of the organ in the cochlea.

26 x 19 x 26 cm  
**M-1010005**



**3B SMART ANATOMY**  
**Ossicle Model, 20 times Life-Size**  
**3B BONElike™**

The three smallest bones that are joined to each other in the human body are located in the middle ear and are referred to as the auditory ossicles: malleus (hammer), incus (anvil) and stapes (stirrup). Using a micro CT technique, an original cast was used to build this 20 times life-size model. In 3B BONElike™ quality.

17 x 12 x 21 cm; 0.39 kg  
**M-1009697**



**3B SMART ANATOMY**  
**Ossicle Model – 20 times Life-Size**  
 17 x 12 x 21 cm; 0.39 kg  
**M-1012786**



**Ossicle Model – Life-Size**

Cast from natural specimen, these human auditory ossicles are presented in their natural position and embedded in transparent acrylic.

**M-1000253**

*Removable auditory ossicles and labyrinth*

➤ **EASY VIEWING ROOM FROM ANYWHERE IN THE CLASSROOM!**



**3B SMART ANATOMY**  
**World's Largest Ear Model, 15 times Life-Size, 3-part**

The giant ear model is suitable for museums and special collections as well as large lecture halls and conferences. Representation of outer, middle and inner ear. The auditory ossicles and the labyrinth with cochlea and vestibulocochlear nerve can be removed and studied in detail. On base.

130 x 120 x 60 cm; 72 kg  
**M-1001266**

### 3B SMART ANATOMY

#### Nose Model with Paranasal Sinuses, 5-part

The upper right half of the face is enlarged 1.5 times to illustrate the structure of the nose with paranasal sinuses.

**The following structures are differentiated by color and visible through the transparent removable skin:**

- Outer nasal cartilages
- Nasal, maxillary, frontal, and sphenoidal sinuses
- Opened maxillary sinus when the zygomatic arch is removed

**The following structures are shown in median section:**

- Nasal cavity, lined with mucosa, with the (removable) nasal conchae
- Arteries of the mucous membrane
- Olfactory nerves
- Innervation of the lateral wall of the nasal cavity, the nasal conchae and the palate

26 x 19 x 24 cm; 0.8 kg

**M-1000254**

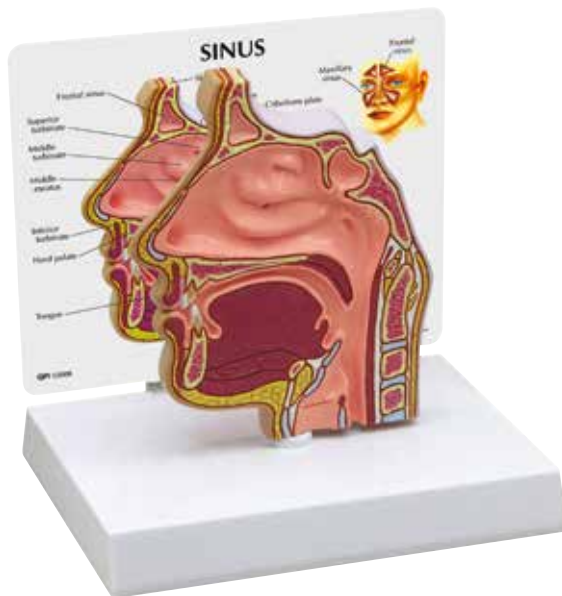
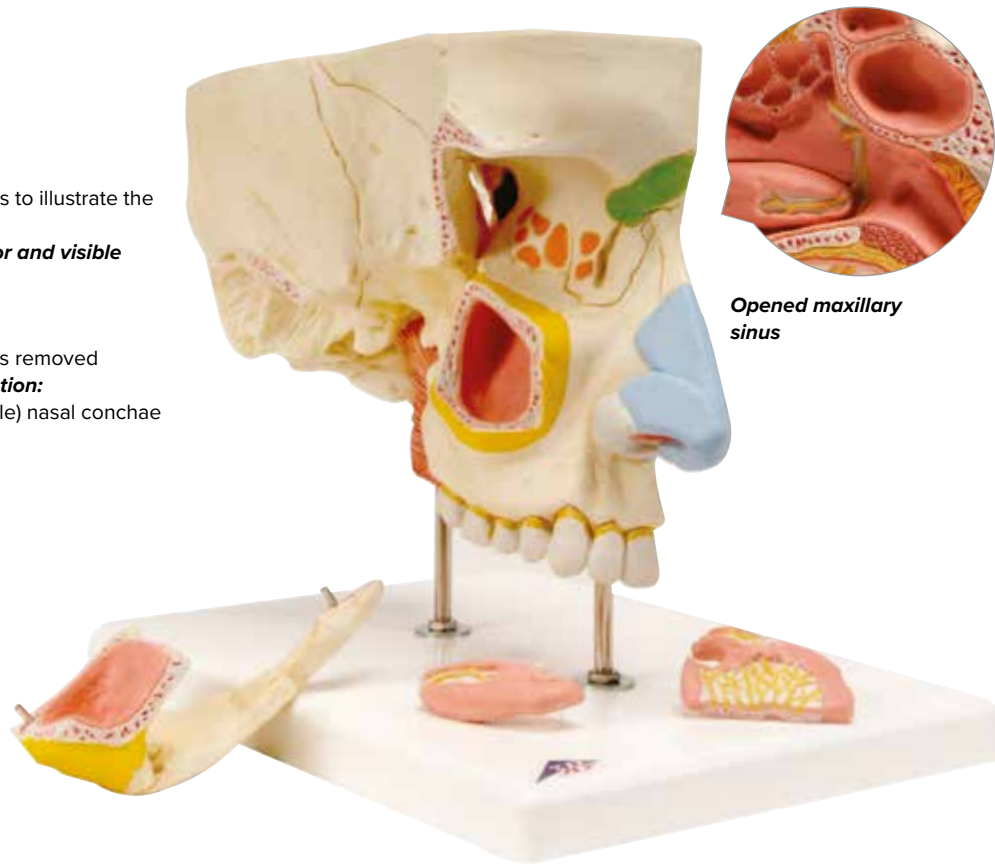

#### Sinus cross section

The Sinus model is a full size cut-away normal model depicts a near median section through the nose and nasal passages. Details include nasal cavity, soft and hard palate, uvula, eustachian tube and pharyngeal tonsil. Reverse side shows ethmoid and maxillary sinus cavities.

11.4 x 1.6 x 13.3 cm

**M-1019537**



#### Thyroid Model

Set of four average size thyroids and one larynx. Models show normal thyroid, Hashimoto's thyroiditis (lymphocytic thyroiditis), Graves' disease, papillary carcinoma and the following structures: hyoid bone, thyroid membrane, thyroid cartilage, cricoid cartilage, and trachea.

**M-1019548**

**3B SMART ANATOMY  
Larynx Model,**

**2 times Life-Size, 2-part**

This detailed larynx model is divided into two halves. It is medially sectioned and shows:

- Larynx
- Hyoid bone
- Windpipe
- Ligaments
- Muscles
- Vessels
- Nerves
- Thyroid gland

14 x 14 x 28 cm; 0.29 kg

**M-1000273**



**3B SMART ANATOMY  
Larynx Model,**

**2 times Life-Size, 7-part**

This medially sectioned model shows:

- Larynx
  - Hyoid bone
  - Windpipe
  - Ligaments
  - Muscles
  - Vessels
  - Nerves
  - Thyroid gland
- Thyroid cartilage, 2 muscles and 2 thyroid gland halves are removable from larynx.

On stand.

12 x 12 x 23 cm; 0.87 kg

**M-1000272**



**3B SMART ANATOMY  
Functional Larynx Model,**

**2.5 times Full-Size**

The epiglottis, vocal cords and arytenoid cartilage are movable in the functional larynx. Additionally the following structures of the human larynx are represented:

- Hyoid bone
- Cricoid cartilage
- Thyroid cartilage
- Thyroid
- Parathyroid glands

9 x 9 x 14 cm; 0.66 kg

**M-1013870**



**3B SMART ANATOMY  
Functional Larynx Model,**

**3 times Full-Size**

The functional model is a great tool for speech therapy!

This functional larynx depicts the epiglottis, vocal cords and arytenoid cartilage.

These parts are movable for demonstration purposes.

32 x 13 x 15 cm; 0.97 kg

**M-1001242**

# DENTITION MODELS



SCAN THE QR CODE ON P. 174 FOR A FREE  
3B SMART ANATOMY DEMO VERSION

## 3B SMART ANATOMY

### Dental Disease, magnified 2 times, 21-parts

Magnified for easier demonstrations!

The model is based on a lower jaw with soft gums and 16 removable teeth. One half shows eight healthy teeth and healthy gums for comparison.

**The other half shows the following dental diseases:**

- Dental plaque
- Dental calculus (tartar)
- Periodontitis
- Inflammation of the root
- Fissure, approximal and smooth surface cavities

One part of the front bone section can be removed from the dental disease model to view the roots, vessels and nerves. Two molars are sectioned along the length to show the inside of the tooth.

Delivered on a base.

17.5 x 26 x 18.5 cm; 0.6 kg

**M-1000016**



➤ **TEACH PROPER CLEANING TECHNIQUES – GIANT TOOTHBRUSH INCLUDED**



*Jaw-shaped stand*

## Dental Morphology Series, 10 times Life-Size, 7-part

At ten times life-size, this dental morphology series has removable lateral incisor, canine, first premolar, a bridge made of artificial first molar with gold colored crown and second molar. All relevant dental morphology structures are labeled. Dental morphology on transparent, jaw-shaped stand. Key card included.

70 x 25.5 x 15 cm; 2.1 kg

**M-1005540**



## 3B SMART ANATOMY

### Giant Dental Care Model, 3 times Life-Size

Teach proper teeth cleaning techniques with this giant dental care model! At 3 times life-size, it shows the upper and lower half of an adult's dentition. A flexible joint between the jaws allows easy movement. 35.5 cm toothbrush included.

18 x 23 x 12 cm; 1.5 kg

**M-1000246**





**3B SMART ANATOMY**

**A. Half Lower Jaw, 3 times Life-Size, 6-part**

The model represents half of the left lower jaw of a young person. One section of bone is removable from the half lower jaw to expose the tooth roots, spongiosa, vessels and nerves. The canine and first molar are removable from the half lower jaw and are longitudinally sectioned. 35 x 18 x 36 cm; 1.2 kg

**M-1000249**

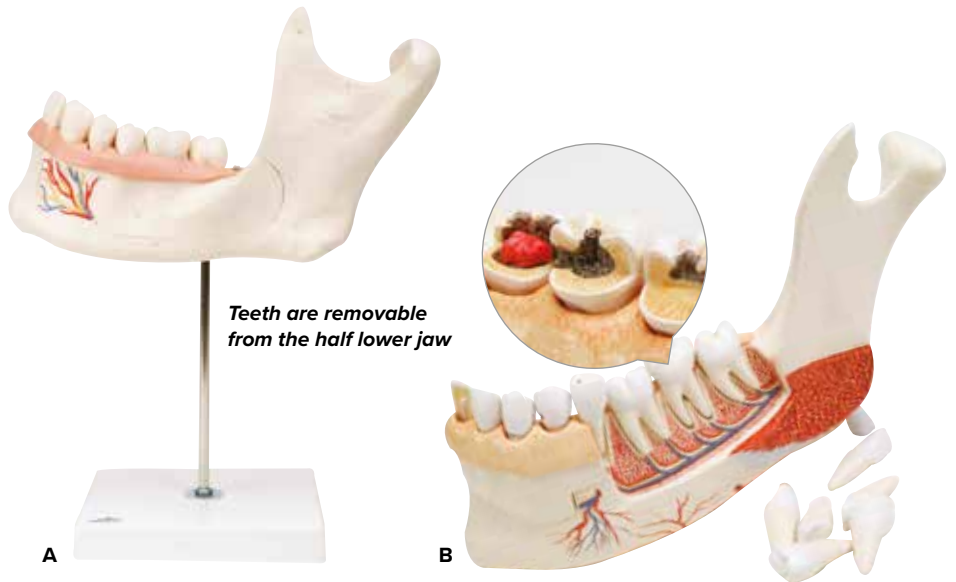

**3B SMART ANATOMY**

**B. Advanced Half Lower Jaw with 8 Diseased Teeth, 19-part**

These diseased teeth show various stages of cavities from a small and easy-to-treat example on an incisor, through to an advanced degradation of a molar, showing the exposed root. The front section of the bone and all the teeth are removable from the half lower jaw, one incisor is longitudinally sectioned. Nerves, blood vessels, the sublingual and submandibular glands are shown. 22 x 32 x 9 cm; 1.1 kg

**M-1001250**



**3B SMART ANATOMY**

**C. Dentition Development**

Cast from natural specimens, these four upper and lower jaw halves show four different stages of development:

- Newborn
- Approx. 5-year old child
- Approx. 9-year old child
- Young adult

33 x 10 x 20 cm; 0.5 kg

**M-1000248**

**C**

**3B SMART ANATOMY**

**D. Milk Dentures**

Upper and lower jaw are opened to show the arrangement of the remaining teeth. On base. 13 x 12 x 13 cm; 0.6 kg

**M-1001248**

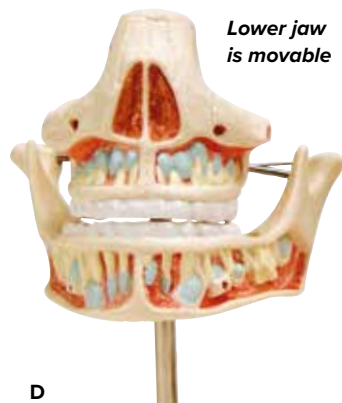

Lower jaw is movable

**3B SMART ANATOMY**

**E. Adult Dentures**

Tooth roots, spongiosa, vessels, and nerves are exposed for detailed study. The lower jaw is movable. On base. 16 x 12 x 13 cm; 0.9 kg

**M-1001247**

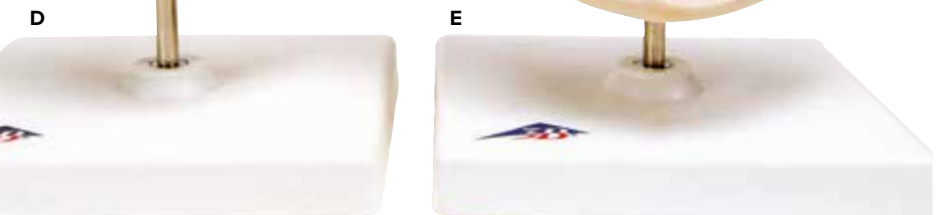



**3B SMART ANATOMY**  
**Giant Molar with Dental Cavities,**  
**15 times Life-Size, 5-part**

This giant molar model depicts an upper triple-root molar and separates into 5 parts. The molar features a longitudinal section through the crown, two roots and the pulp cavity. The giant molar contains removable pulp and three tooth inserts with different stages of advanced cavities.

Delivered on stand.  
 24 x 12 x 13 cm; 1.5 kg

**M-1013215**

*Easily switched between 3 stages of cavities*



➤ EACH TOOTH MODEL IN THIS SET IS ALSO AVAILABLE INDIVIDUALLY

**3B SMART ANATOMY**  
**Classic Tooth Models**

*This classic tooth series shows 5 representative types of adult dentition individually mounted on removable stands:*

- 2-part lower incisor with longitudinal section
- 2-part lower canine with longitudinal section
- Lower single-root pre-molar
- 2-part lower twin-root molar with longitudinal section showing caries attack
- 3-part upper triple-root molar with longitudinal section and caries insert

The series ranges from 23-29 cm high. Each tooth delivered on a base.  
**M-1017588**



**3B SMART ANATOMY**  
 Lower Incisor,  
 2-part  
**M-1000240**

**3B SMART ANATOMY**  
 Lower Canine,  
 2-part  
**M-1000241**

**3B SMART ANATOMY**  
 Lower Single-Root  
 Pre-Molar  
**M-1000242**

**3B SMART ANATOMY**  
 Lower Twin-Root Molar,  
 2-part  
**M-1000243**

**3B SMART ANATOMY**  
 Upper Triple-Root Molar,  
 3-part  
**M-1017580**



**Skull Model with Teeth for Extraction, 4-part**

This anatomical human skull is a great tool for students. The teeth of the upper and lower jaw can be extracted from the skull and replaced individually with their fully formed roots. A bone flap on the right mandible of the skull can be opened to view the dental roots, spongiosa, nerve canal and an impacted wisdom tooth.

- Features individual teeth with roots
- Practice extraction time and again
- Naturally articulating jaw

22 x 13.5 x 17 cm; 0.8 kg

**M-1003625**



**Clear Human Jaw with Teeth Model**

Full size hinged clear cast jaw to allow viewing of roots. Healthy side shows normal dentition and occlusion. Affected side shows multiple pathologies, including: super eruption, apical alveolar abscess with caries, periodontal disease, lateral abscess, abfraction, irregular root curvature, impacted canine, erosion, fractured tooth, horizontal impact, radicular pulpitis, root canal with crown, internal resorption, attrition, external resorption of root, implants, and fractured root.

7.1 x 6.4 x 6.4 cm

**M-1019540**

*Highly detailed model showing the various papillae of the tongue and taste buds*



*Can be taken apart easily*



**3B SMART ANATOMY**

**3B MICROanatomy™ Tongue**

This highly detailed model comprises a macroscopic view of the tongue (dorsal view) and microscopic views of the various papillae of the tongue (10-20x life-size) and of a taste bud (approx. 450x life-size). All views are mounted on a base that also features an overview of the sensory and sensitive innervations of the tongue.

14.5 x 32.5 x 20 cm; 0.8 kg

**M-1000247**

**3B SMART ANATOMY**

**Tongue Model, 2.5 times Life-Size, 4-part**

This model shows the lower jaw up to the second molar, the tongue with mouth floor musculature in median section and the right sublingual and submandibular gland. On removable base.

23 x 17 x 16 cm; 0.8 kg

**M-1002502**

# HEART MODELS



SCAN THE QR CODE ON P. 174 FOR A FREE  
3B SMART ANATOMY DEMO VERSION

+

## Classic Heart Model Series

- + Removable parts for closer study
- + Ideal for student and patient education
- + Durable and virtually unbreakable material

### 3B SMART ANATOMY

#### Classic Heart, 2-part

The 2-part classic heart is highly detailed and at a price you will love. Just slightly smaller than life-size with exquisite detail throughout including ventricles, atria, valves, veins, and the aorta. The front heart wall is detachable to reveal the chambers and valves inside.

On removable stand.

19 x 12 x 12 cm; 0.3 kg

**M-1017800**

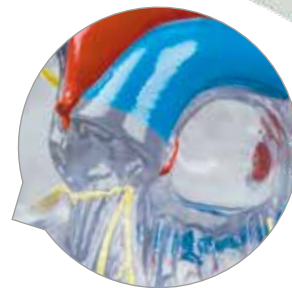
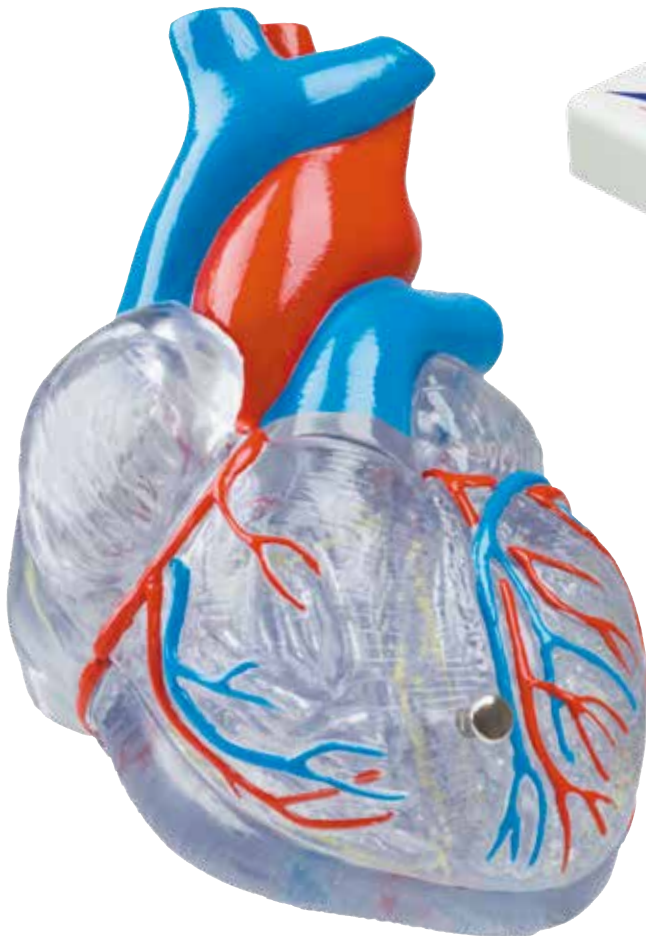
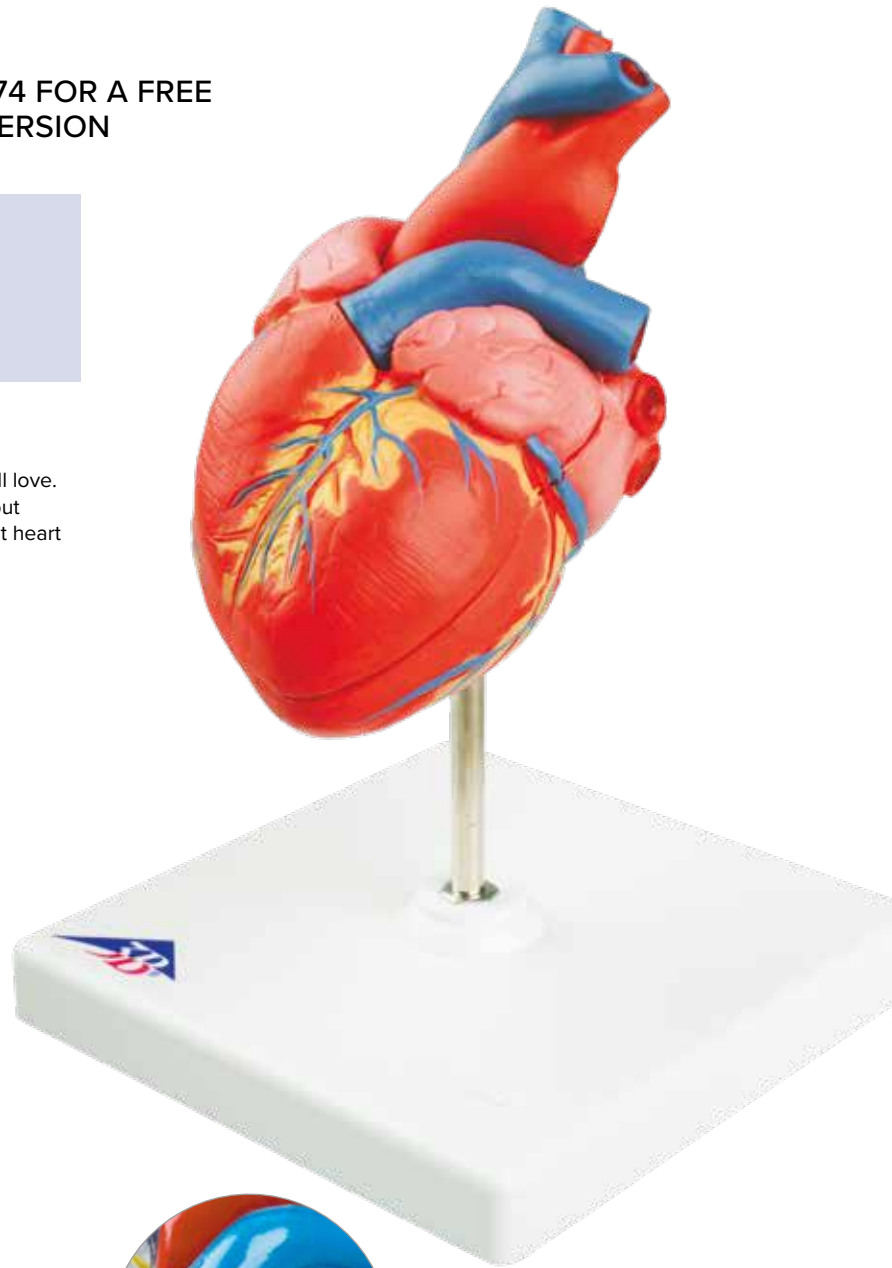

*Conducting system inside*

### 3B SMART ANATOMY

#### Classic Heart with Conducting System, 2-part

This unique transparent model shows the anatomy of the heart complete with its conducting system represented in color. The front heart wall is removable and the entire heart can be removed from the stand.

19 x 12 x 12 cm; 0.2 kg

**M-1019311**

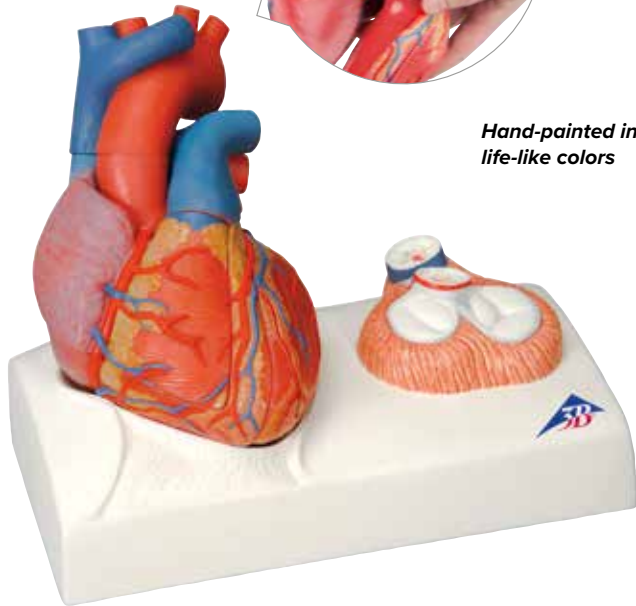

*Hand-painted in life-like colors*

## › LIFE-SIZE CAST FROM REAL SPECIMEN

### 3B SMART ANATOMY

#### Magnetic Heart Model, Life-Size, 5-part with Diastole and Systole

Now, in one detailed model, the study of diastole and systole is finally made straightforward and convenient. This unique dissection makes the viewing of the cardiac valves during diastole with closed pulmonary aortic valves and opened mitral tricuspid valves easier than ever before. In addition to this the closed mitral tricuspid valves and opened pulmonary aortic valves during systole are represented in a second model located on the base.

- Easy to open, magnetic connections
- Extremely detailed, life-size model
- Cast from real specimen
- Shows both diastolic and systolic state

25 x 21 x 13 cm; 1.52 kg

**M-1010006**

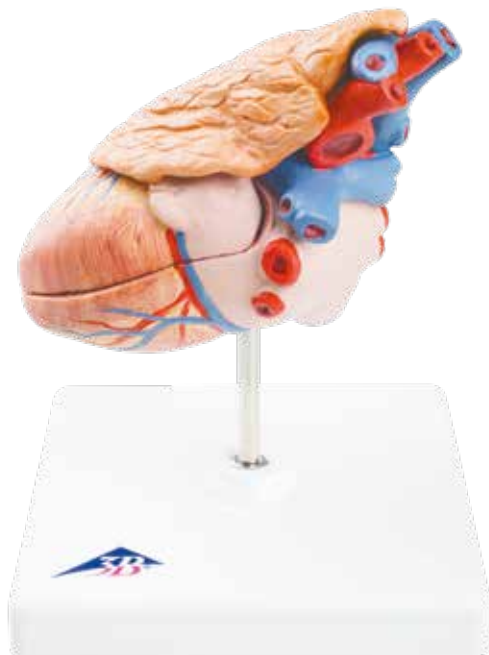
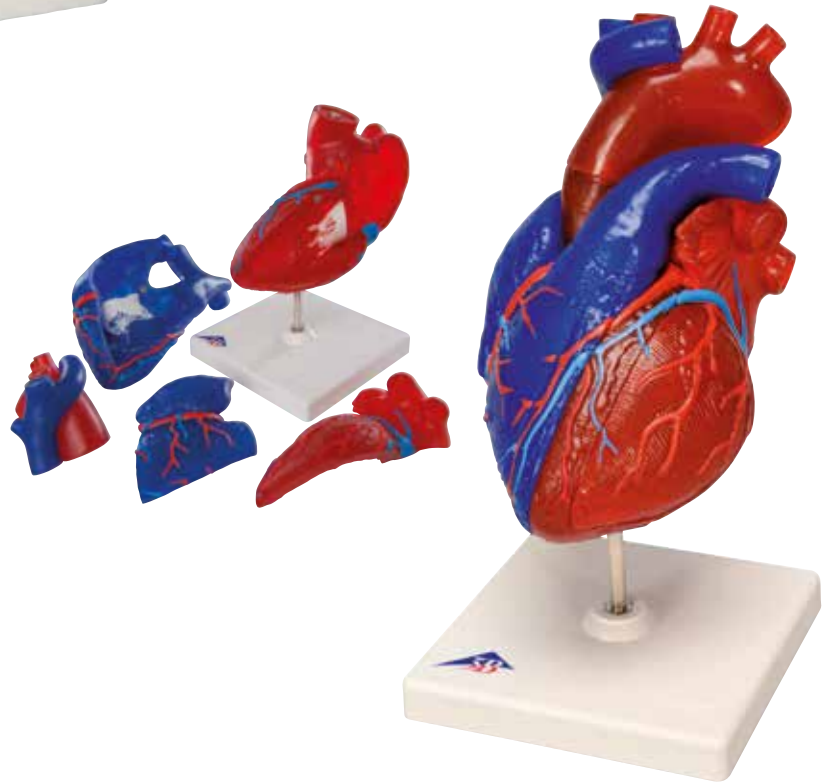

## › THYMUS

### 3B SMART ANATOMY

#### Classic Heart with Thymus, 3-part

In addition to the features of the 2-part classic heart, this model also shows the location and relative size of the thymus.

20 x 12 x 12 cm; 0.3 kg

**M-1000265**

### 3B SMART ANATOMY

#### Didactically Painted Heart Model, Magnetic, Life-Size, 5-part

Invest in quality with this uniquely sectioned 5-part heart model by 3B Scientific. Cast from a real human heart and didactically prepared to facilitate a better understanding of the anatomy and blood flow of the heart. A dissection through the median plane makes an easy demonstration possible. Color scheme and disassembly of the heart model in a didactical manner. The chambers of the heart and vessels (including coronary vessels) in which oxygen-rich blood is transported have been displayed in red. Heart chambers and vessels which contain blood low in oxygen have been reproduced in blue.

13 x 19 cm; 0.6 kg

**M-1010007**

➤ **MAGNIFIED MODELS FOR EASY IDENTIFICATION OF ALL ANATOMICAL STRUCTURES IN THE HUMAN HEART**

**3B SMART ANATOMY**

**Heart, 2 times Life-Size, 4-part**

This 2 times life-size heart model allows very easy identification of all structures and is a perfect aid for lessons in big classrooms or lecture halls. The anatomy of the human heart is shown in great detail with ventricles, atria, valves, veins, and the aorta. The front heart wall can be removed to reveal the chambers and valves inside. Comes with a removable base.

32 x 18 x 18 cm; 1.3 kg

**M-1000268**

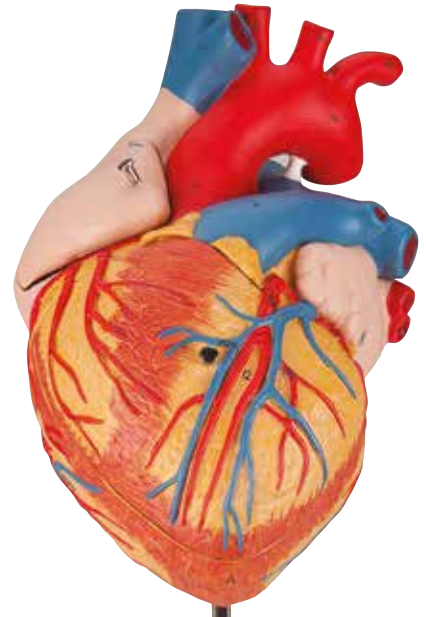

**3B SMART ANATOMY**

**Heart on Diaphragm, 3 times Life-Size, 10-part**

This unique model depicts the structures of the heart while detailing how the heart relates to the thoracic diaphragm at 3 times life-size. Easily show how the diaphragm separates the thoracic cavity from the abdominal cavity.

**The following parts of the heart can be removed for detailed study:**

- Esophagus
- Trachea
- Superior vena cava
- Aorta Pulmonary artery stem
- Both atrium walls
- Both ventricle walls

Non-removable base.

41 x 33 x 28 cm; 3.6 kg

**M-1008547**

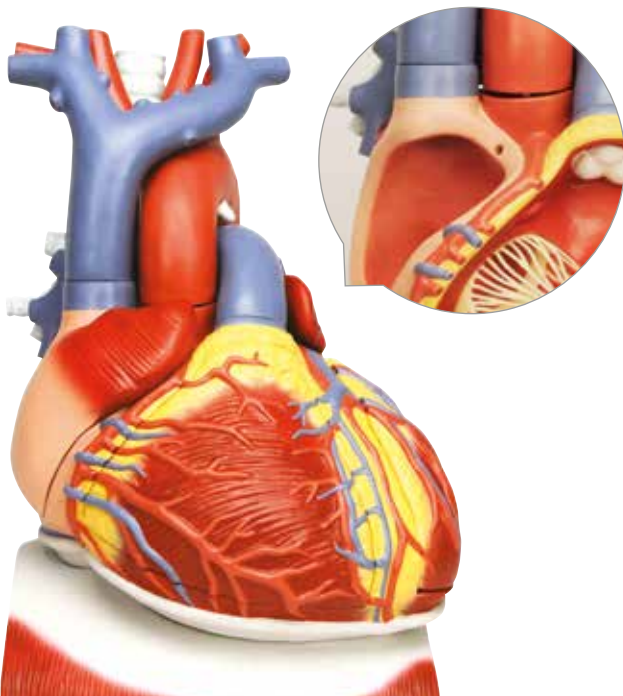
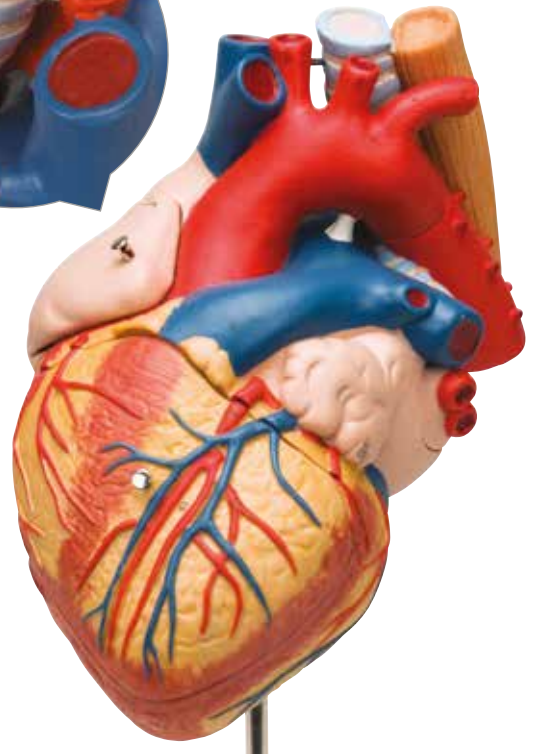

**3B SMART ANATOMY**

**Heart with Esophagus and Trachea, 2 times Life-Size, 5-part**

This 2-times life-size heart model allows a very easy identification of all structures in the human heart. The atrium walls and the front heart wall are removable to reveal the inside. Additionally, the upper section of the esophagus, the upper bronchi and the ascending aorta and the front heart wall and the atrium walls can be removed. Hand-painted in life-like colors. On removable stand.

32 x 18 x 18 cm; 1.3 kg

**M-1000269**

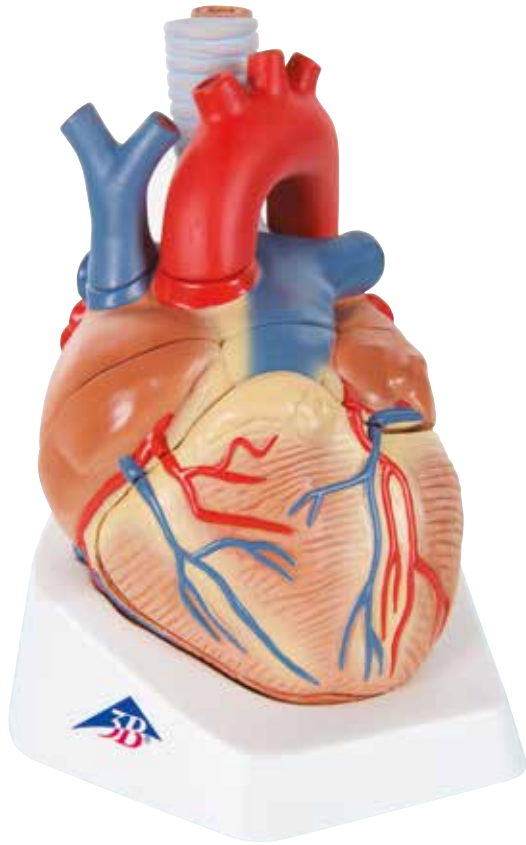

**3B SMART ANATOMY**

**Heart, 1.5 times Life-Size, 7-part**

This high quality model clearly shows over 30 different anatomical regions in the heart. The model is horizontally sectioned at the level of the valve plane.

**The following parts can be removed for detailed study:**

- Esophagus
- Trachea
- Superior vena cava
- Aorta
- Front heart wall
- Upper half of the heart

On base.

20 x 15 x 17 cm; 1.1 kg

**M-1008548**



**Accurately modeled bicuspid and major vessels**

100 cm

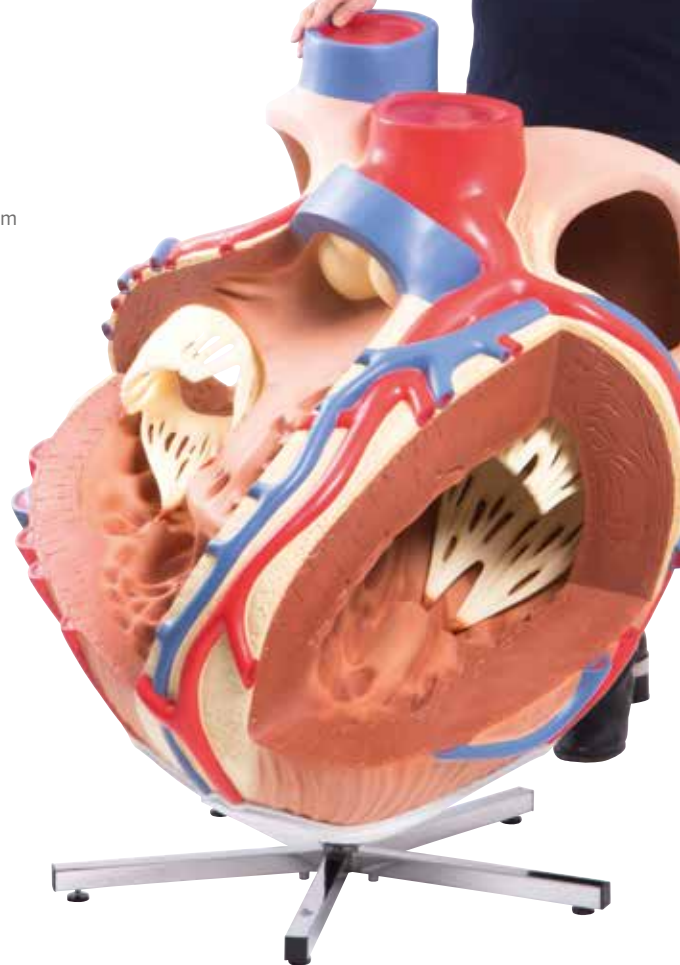

**3B SMART ANATOMY**

**Giant Heart, 8 times Life-Size**

This gigantic heart is one of a kind!

See every detail of the heart with this giant 8 times life-size model. Constructed by hand, it is of great quality. The atria and ventricles of the heart are open to give a view of the interior, and show the accurately modeled bicuspid and major vessels adjacent to the heart. The coronary heart vessels are also shown in amazing detail. On stand.

100 x 90 x 70 cm; 35 kg

**M-1001244**

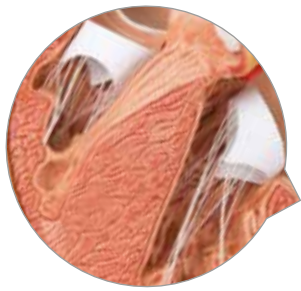

**With Left Ventricular Hypertrophy (LVH)**

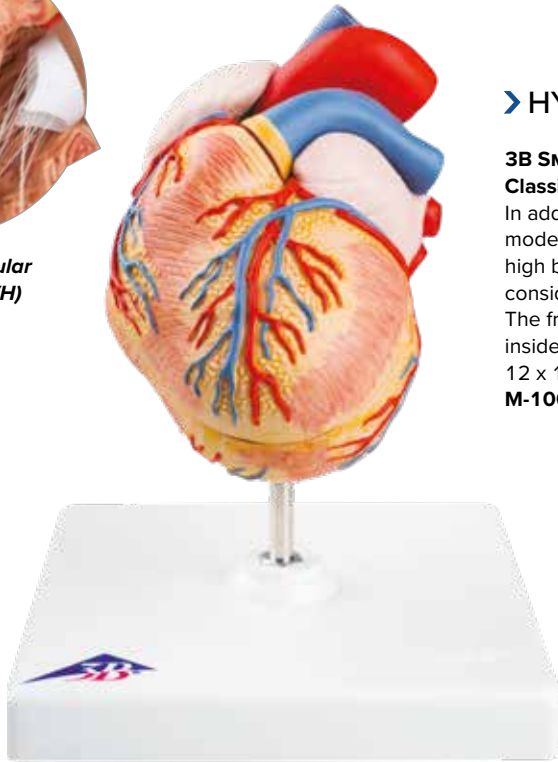

## ➤ HYPERTROPHY

### 3B SMART ANATOMY

#### Classic Heart with Left Ventricular Hypertrophy (LVH), 2-part

In addition to all the features of the 2-part classic heart, this unique model shows the long-term effects of increased heart activity due to high blood pressure. The muscular wall of the left heart ventricle is considerably thickened and the tip of the heart is visibly rounded off. The front heart wall is detachable to reveal the chambers and valves inside. On removable stand.

12 x 12 x 14 cm; 0.45 kg

**M-1000261**

## ➤ BYPASSES

### 3B SMART ANATOMY

#### Heart with Bypass, 2 times Life-Size, 4-part

This 2 times life-size heart is great for large lecture halls or classrooms. The front heart wall can be removed to view the inner chambers. In addition, this model shows a venous bypass to the ramus postero-lateralis of the right coronary artery, to the ramus interventricularis ant. of the left coronary artery with branching to the ramus diagonalis as well as a bypass to the ramus circumflexus of the left coronary artery. On removable stand.

32 x 18 x 18 cm; 1.1 kg

**M-1000263**

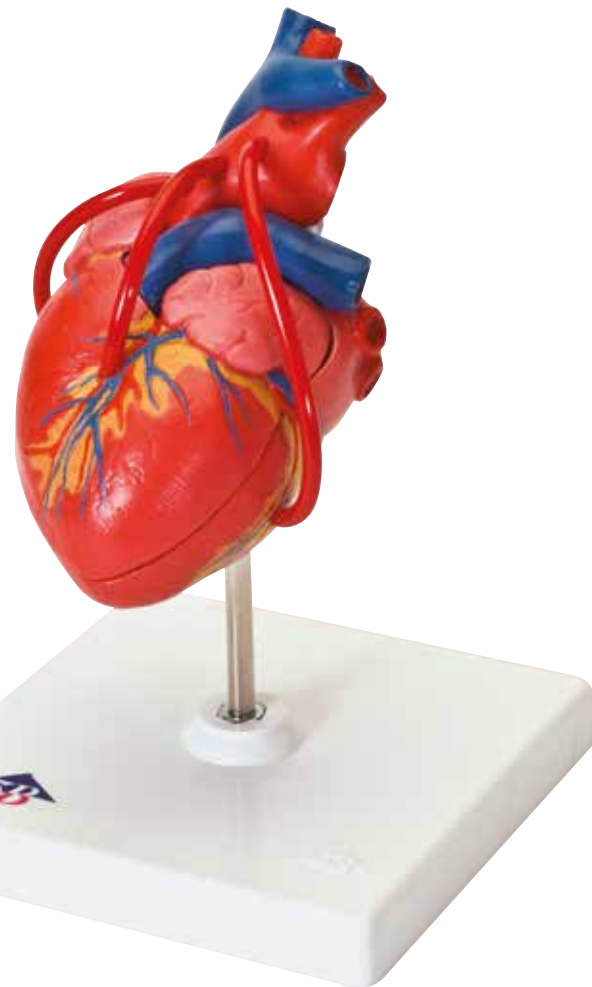
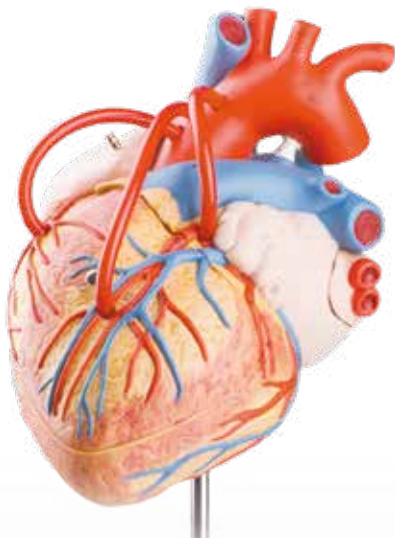

### 3B SMART ANATOMY

#### Classic Heart with Bypass, 2-part

With all the features of the 2-part classic heart, but also includes venal bypasses to the right coronary artery, to the ramus interventricularis anterior, and also to the ramus circumflexus of the left coronary artery, which are shown in color. This model is a great aid in explaining coronary heart disease. On removable stand.

19 x 12 x 12 cm; 0.35 kg

**M-1017837**



## ➤ ACCURATE TEACHING AIDS OF THE CIRCULATORY SYSTEM



### 3B SMART ANATOMY 3B MICROanatomy™ Artery and Vein, 14 times Life-Size

This model, enlarged 14 times, shows a medium-sized muscular artery with two adjacent veins from the antebrachial area with adjoining fat tissue and muscle.

- Illustrates reciprocal anatomical relationship of artery and vein and basic functional techniques of venous valves
- Left vein and middle artery are fenestrated in upper anterior segment, revealing various layers of wall structure in cross and longitudinal section and top view
- Right vein is opened throughout in anterior segment, revealing orifice of a feeder vein and two venous valves formed by a duplication of the tunica intima

On the back of the model, a relief of two veins illustrates the functional aspect of the venous valves. Supplied on base.

26 x 19 x 18.5 cm; 0.9 kg

**M-1000279**



### Artery Sections – with Handle

Four-stage cross-section of an artery demonstrating arteriosclerosis in which the narrowing of the artery is due to a build up of fatty tissue (cholesterol) and plaque. Four stages: normal artery, fatty streak, fibrous plaque, and blockage. The stages cause a decrease in blood flow, which can lead to a blood clot or thrombus. All stages rotate on hinge pin.

8.1 x 3.2 x 4.6 cm

**M-1019532**



### 3B SMART ANATOMY Arteriosclerosis Model, with Cross Section of Artery, 2-part

With the help of this artery model doctors can explain changes in the blood vessels due to arteriosclerosis. A horizontally dissected artery fork is depicted with arteriosclerotic changes in four different stages, from slightly sedimented to a completely clogged blood vessel. On stand.

14 x 10 x 7 cm; 0.2 kg

**M-1000278**



### Hypertension Set

The Hypertension Set includes a miniature brain, eye, heart, kidney and artery models. Education card illustrates effects associated with hypertension: ocular pathologies, arteriosclerosis, arterial plaque, kidney failure and stroke.

16.5 x 12.7 x 27.9 cm

**M-1019572**



### 3B SMART ANATOMY Circulatory System, 1/2 Life-Size

This half life-size relief model of the human circulatory system details the following anatomical structures:

- The arterial/venous system
- Heart
- Lung
- Liver
- Spleen
- Kidneys
- Partial skeleton
- A colorful and anatomically accurate teaching aid of the human circulatory system

Delivered on baseboard for easy display in a classroom or doctor's office.

80 x 30 x 6 cm; 3.6 kg

**M-1000276**



### Artery Model

Artery Model features an oversized "Y" section of artery, with cut-away, showing gradual build-up of cholesterol deposits.

15.9 x 5.1 x 10.2 cm

**M-1019531**

# LUNG MODELS



SCAN THE QR CODE ON P. 174 FOR A FREE  
3B SMART ANATOMY DEMO VERSION

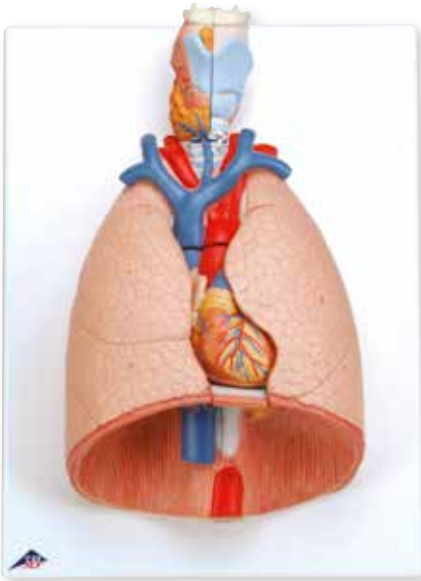

## 3B SMART ANATOMY

### Lung Model with Larynx, 5-part

This high quality lung model comes on a baseboard and can be disassembled into 5 parts, lung and heart are removable.  
37 x 28 x 12 cm; 1.25 kg

**M-1001243**



## 3B SMART ANATOMY

### Lung Model with Larynx, 7-part

The lung model with larynx comes on a baseboard for easy display. It is of highest quality, and contains removable parts.

41 x 31 x 12 cm; 2.2 kg

**M-1000270**



## 3B SMART ANATOMY

### Segmented Lung, Magnetic, 20-part

This high quality lung model is detachable into two lobes and single segments. The segments are color-coded and their position can be easily identified in the bronchial tree. The bronchial tree contains the lobar bronchi and segmental bronchi. All segments are connected by magnets which allow a safe and easy handling.

25 x 25 x 35 cm; 4.1 kg

**M-1008494**

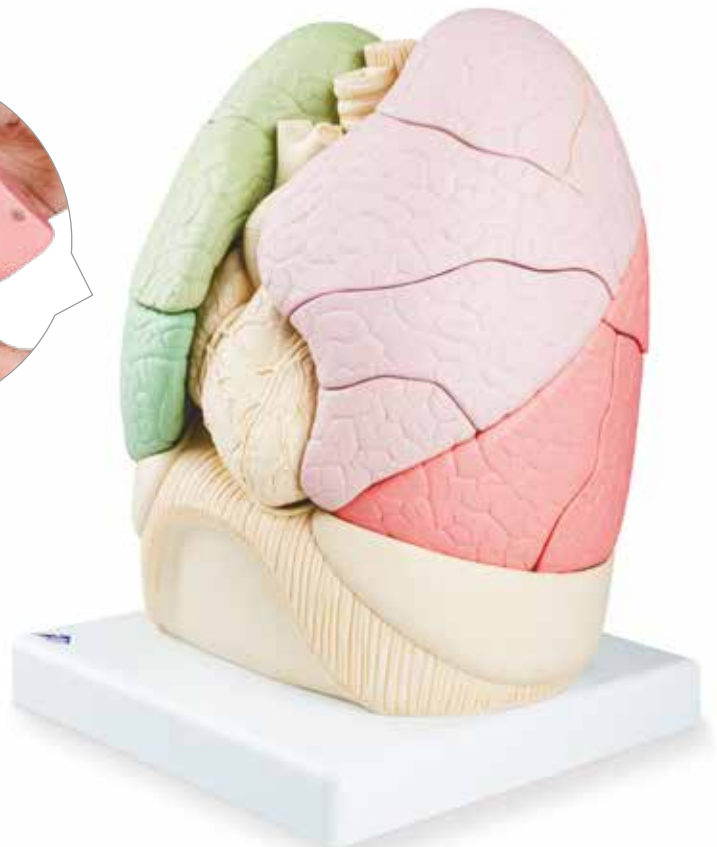

**3B SMART ANATOMY**  
**CT Bronchial Tree with Larynx and**  
**Transparent Lungs**

This unique model was created on the basis of computer tomography data of a human male. The larynx is detachable at the level of the second tracheal cartilage and divisible in the median plane. The epiglottis is mounted flexibly. The various segmental bronchi are made of elastic material and depicted in various transparent colors so that they are easier to distinguish visually. The transparent lungs are detachable.

22 x 18 x 37 cm; 1.23 kg

**M-1000275**



**3B SMART ANATOMY**  
**CT Bronchial Tree without Lungs**

22 x 18 x 37 cm; 0.43 kg

**M-1000274**



**3B SMART ANATOMY**  
**Pulmonary Lobule with**  
**Surrounding Blood Vessels**

The model shows an external pulmonary lobule at 130 times life-size. A graphic image on the stand of the model shows the structure of the airway in the lungs up to the alveolus.

26 x 33 x 19 cm; 1.35 kg

**M-1008493**

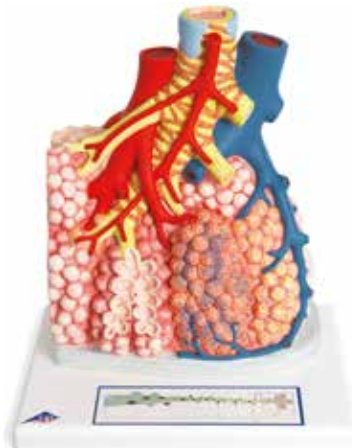

**3B SMART ANATOMY**  
**COPD Model**

Shows changes to the bronchial tissue from normal to permanent damage and after administration of medication.

15 x 11 x 8 cm; 0.18 kg

**M-1012788**

**4-Piece Bronchus Model**

The 4-piece bronchus model is a four stage cross-section of the bronchus demonstrating the tissue changes occurring in asthma and chronic bronchitis. Four stages: normal bronchus, hypersecretion of the mucous gland, swelling with lymphoid aggregations and smooth-muscle spasm. The model includes: cartilage, mucous glands and plug, spiraling smooth muscles, and the fibroelastic connective tissue and epithelial layers of the bronchus. All stages rotate on hinge pin.

9.4 x 3.8 x 4.4 cm

**M-1019547**



# DIGESTIVE & URINARY SYSTEM MODELS



SCAN THE QR CODE ON P. 174 FOR A FREE  
3B SMART ANATOMY DEMO VERSION



## 3B SMART ANATOMY Digestive System, 3-part

This life-size model demonstrates the entire digestive system in graphic relief.

**The following parts are shown, painted in realistic colors:**

- Nose
- Mouth cavity and Pharynx
- Esophagus
- GI tract
- Liver with gallbladder
- Pancreas
- Spleen

The duodenum, caecum and rectum of the digestive system are opened. The transverse colon and front stomach wall are removable from the digestive system for detailed study of the anatomy. The liver, stomach and transverse colon are removable.

81 x 33 x 10 cm; 4.4 kg

**M-1000307**

## 3B SMART ANATOMY Digestive System, 2-part (not shown)

Same features as the 3-part model, but without the removable stomach half.

**M-1000306**



## 3B SMART ANATOMY

### 3B MICROanatomy™ Digestive System – 20 times magnified

This model illustrates the structure of the fine tissues of four characteristic sections of the digestive system 20 times magnified:

- Esophagus
- Stomach
- Small intestine
- Large intestine

The front of the model, from top to bottom, shows a magnified view, in histological section, of the individual sections of the digestive system and their fine tissue structures. The back of the model has highly magnified views of didactically interesting areas of each section shown on the front.

29.5 x 26 x 18.5 cm; 1.5 kg

**M-1000311**



## 3B SMART ANATOMY

### Intestinal Villi, 100 times Life-Size

This intestinal villi model consists of one entire villus, one longitudinally sectioned villus showing the arterioles and venules, and one sectioned villus to show the lymphatic vessels. Also includes a longitudinal section of Lieberkühn's crypt. Mounted on base.

43 x 28 x 10 cm

**M-1005532**



**3B SMART ANATOMY**

**Stomach, 3-part**

Shows the layers of the stomach wall from cardia to pylorus. The front stomach half and the opened duodenum with pancreas are removable.

**Shown are:**

- The lower esophagus
- Vessels
- Duodenum
- Pancreas
- Nerves

25 x 22 x 12 cm; 0,8 kg

**M-1000303**

**3B SMART ANATOMY**

**Stomach, 2-part (not shown)**

Like the one above but the Duodenum and Pancreas are not present. The front half of the stomach is removable for detailed study. It shows the lower esophagus, vessels, and nerves.

25 x 22 x 12 cm; 0,6 kg

**M-1000302**

**3B SMART ANATOMY**

**Gastric Band Model**

This model was developed based on the two-part stomach model with the addition of an SAGB Quick Close® gastric band. A gastric band is inserted surgically to treat morbid obesity if conservative treatments are unsuccessful. This model is highly suitable as a tool for explaining the device to patients.

3 x 3 x 4 cm; 0,5 kg

**M-1012787**

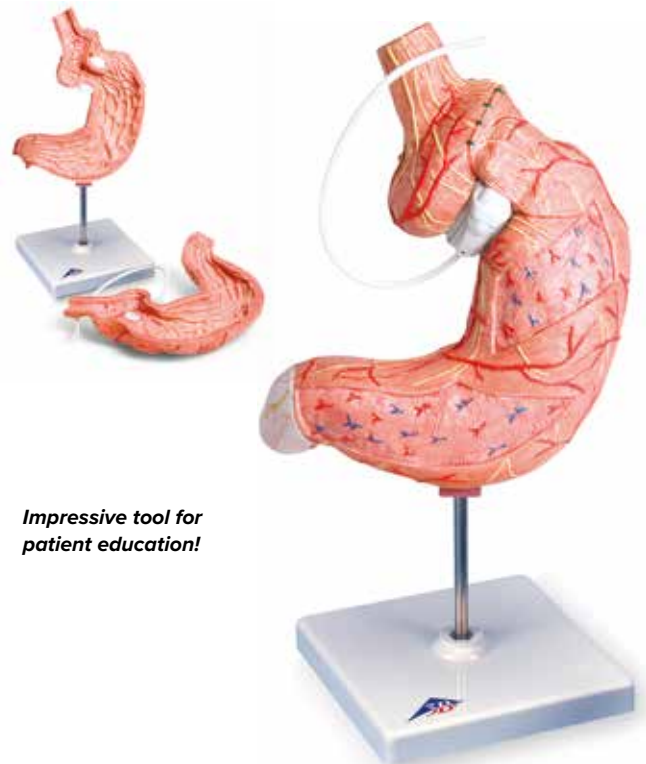

*Impressive tool for patient education!*

**3B SMART ANATOMY**

**Stomach with Ulcers**

The ½ life-size stomach pathology model demonstrates various stages of gastritis from a light gastric ulcer to a perforation. Correspondingly, the base shows an enlarged stomach wall to further demonstrate these changes.

14 x 10 x 17 cm; 0,3 kg

**M-1000304**

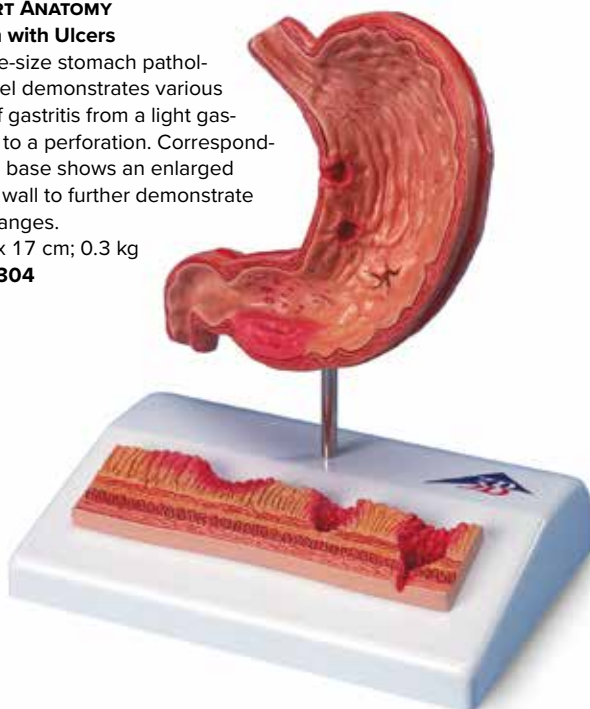

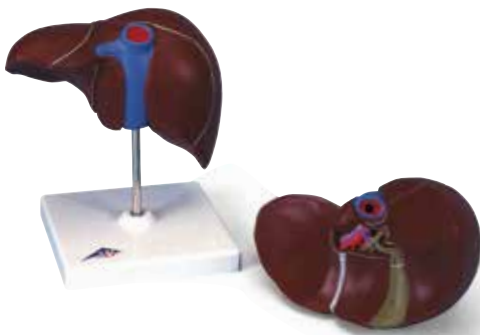

**3B SMART ANATOMY**  
**Liver with Gallbladder**

This realistic model shows the anatomy of the liver and gallbladder. Mounted on base.

**It shows:**

- 4 lobes with gallbladder
- Extrahepatic ducts
- Hilus vessels

18 x 18 x 12 cm; 0.5 kg

**M-1014209**

**3B SMART ANATOMY**

**Liver with Gallbladder, Pancreas and Duodenum**

*This highly-detailed relief model provides a detailed look at the liver with:*

- Ducts
- Gallbladder
- Pancreas
- Duodenum
- Vessels
- Extrahepatic ducts with gallbladder
- Main pancreatic duct and their orifices

Delivered on baseboard.

4 x 20 x 18 cm; 0.8 kg

**M-1008550**

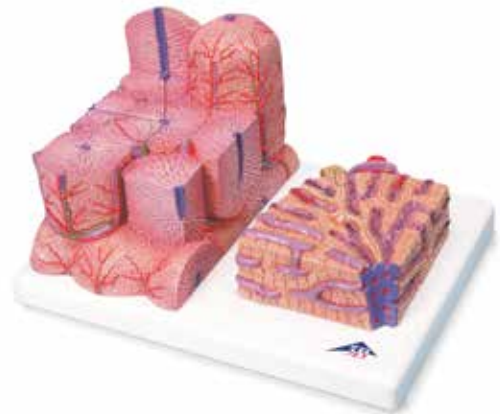
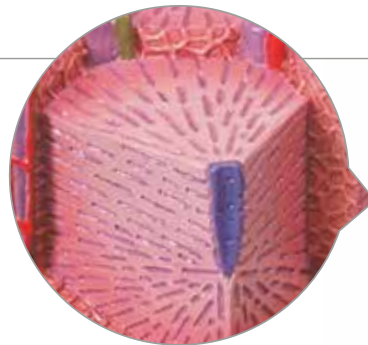

**3B SMART ANATOMY**  
**3B MICROanatomy™ Liver**

This 2-part model shows a highly magnified view of a section of the liver. It illustrates the functional and structural components with two different enlargements. The left part shows a section of the liver that comprises several liver lobules. The right part of the model is a highly magnified view of the sectioned liver lobule on the left. Mounted on base.

15 x 26 x 18.5 cm; 0.7 kg

**M-1000312**



**3B SMART ANATOMY**  
**Kidneys with Vessels – 2-part**

Life-size model presenting the kidneys with suprarenal glands, the outgoing ureters, the renal vessels, and the large vessels situated close to the kidneys. The front half of the right kidney can be removed to reveal the renal pelvis, the renal calices, the renal cortex, and the renal medulla. Comes on stand.

21 x 18 x 28 cm; 1 kg

**M-1000308**

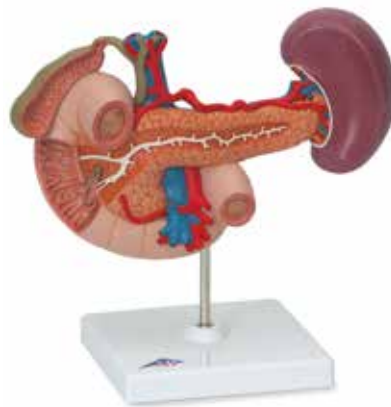

**3B SMART ANATOMY**  
**Rear Organs of the Upper Abdomen**

Representing the duodenum, which is partially opened, along with opened gallbladder and bile ducts. The model also includes the pancreas, revealing large ducts, the spleen, and the surrounding vessels, all in natural size. Comes on stand.

23 x 12 x 20 cm; 0.55 kg

**M-1000309**



**3B SMART ANATOMY**  
**Kidneys with Rear Organs of the Upper Abdomen – 3-part**

This model combines the rear organs of the upper abdomen and the kidneys with vessels in one. The upper abdominal organs are attached in their natural positions and are removable from the kidneys. Comes on stand.

24 x 18 x 29 cm; 1.4 kg

**M-1000310**

## ▶ PATHOLOGICAL MODELS



### 3B SMART ANATOMY Diseases of the Esophagus

Reaching from the lower part of the oesophagus to the upper part of the stomach, this vivid, life-size frontal section shows many common conditions like ulcer, reflux oesophagus, and hiatal hernia. Mounted on base.

14 x 10 x 19 cm; 0.3 kg

**M-1000305**



### 3B SMART ANATOMY Gallstone Model

The anatomy of the biliary system and its surroundings are shown at 1/2 natural size in this graphic model for education. Both acute inflammation and the tissue changes caused by chronic inflammation can be identified in the gallbladder wall. Mounted on base.

14 x 10 x 19 cm; 0.39 kg

**M-1000314**



### 3B SMART ANATOMY Haemorrhoid Model

The model is a life-size frontal section of the rectum as well as a smaller relief on a pedestal. In addition to the anatomical structures of the rectum (sphincter, mucous membrane, venous plexus), the model shows internal haemorrhoids during stage I and II as well as external haemorrhoids. The relief exhibit shows haemorrhoids during stage III and IV. Mounted on base.

14 x 10 x 14 cm; 0.2 kg

**M-1022524**



### 3B SMART ANATOMY Intestinal Diseases

This model shows the usual benign and malignant changes in the colon and rectum. These include diverticula, polyps, haemorrhoids, fistulae, fissures, chronic inflammatory diseases (Crohn's disease and ulcerative colitis), as well as intestinal cancer in various stages. Mounted on base.

21 x 17 x 27 cm; 0.96 kg

**M-1008496**

### Rectum Cross Section (oversize) with Pathologies

One and one half times life size cut-away model displaying ulcerative colitis, internal and external fistula, internal and external hemorrhoids, annular cancer, sessile polyp, submucosal abscess, skin tag, pedunculated polyp, supralelevator abscess, ischioirectal abscess, cryptitis, diverticulum, condyloma acuminatum, fissure and condyloma latum.

14 x 6.4 x 17.8 cm

**M-1019557**



**3B SMART ANATOMY**  
**Kidney Stone Model**

A great tool to inform patients about kidney stones and urinary stones. The model shows an opened right kidney in natural size. The renal calices, the renal pelvis, and the ureter are opened as well enabling concretions or stones to be identified in typical positions.

Mounted on base.  
 14 x 10 x 16.5 cm;  
 0.18 kg

**M-1000316**



**3B SMART ANATOMY**  
**Kidney with Adrenal Gland, 2-part**

The front half of the kidney is removable to enable demonstration of cortex medulla and vessels. The renal pelvis of the kidney is also displayed. 20 important structures are included in the anatomy key.

- Kidney with adrenal gland
- Renal and adrenal vessels of the kidney
- Upper portion of ureter for the human kidney

On stand.

8.5 x 19 x 26 cm; 0.9 kg

**M-1014211**

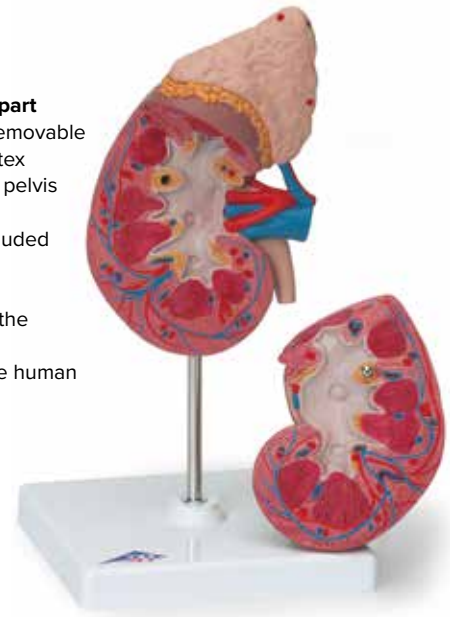

**3B SMART ANATOMY**

**Kidney Section, Nephrons, Blood Vessels and Renal Corpuscle**

These 3 kidney models create a complete series to study the anatomy of the kidney and the different structures of the kidney in great detail. All important structures are numbered and identified in the product guide.

**Together the human kidney models show:**

- A longitudinal section of the right kidney, 3 times life-size
- A kidney nephron depicting a section through renal cortex and medulla
- Nephron features the renal corpuscles with proximal and distal convoluted tubules, loops of Henle, collecting tubules and blood vessels, 120 times full-size
- The third kidney section shows an opened Malpighian corpuscle with glomerulus and Bowman's capsule, 700 times life-size of the human kidney

Mounted on baseboard.

29 x 52 x 9 cm; 2.8 kg

**M-1000299**

**Also available as individual models:**

- |                                       |                  |
|---------------------------------------|------------------|
| <b>Kidney</b>                         | <b>M-1000296</b> |
| <b>Nephrons and Blood Vessels</b>     | <b>M-1000297</b> |
| <b>Malpighian Corpuscle of Kidney</b> | <b>M-1000298</b> |

**Six zones illustrate fine-tissue structures of the human kidney**

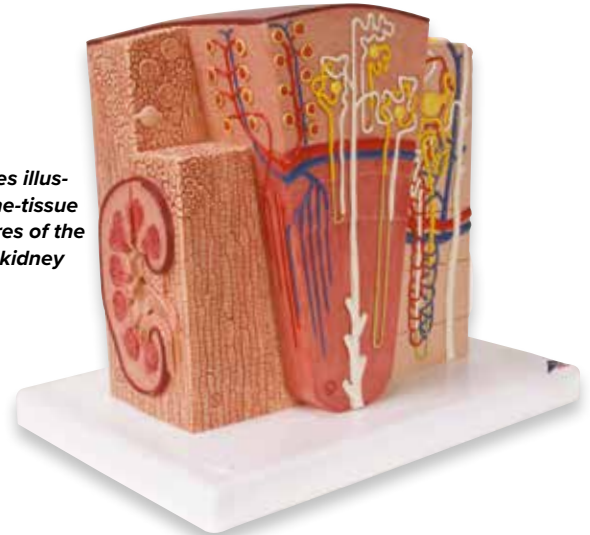

**3B SMART ANATOMY**

**3B MICROanatomy™ Kidney**

This extremely detailed model shows the functional units of the kidney greatly magnified.

**Six model zones illustrate the following fine-tissue structures:**

- Longitudinal section of a kidney
- Section of renal cortex and renal medulla of the kidney
- Wedge-shaped section of a kidney lobe with a diagrammatic depiction of three nephrons with varying lengths of loop of Henle and diagrammatic depiction of the vascular supply
- Diagrammatic illustration of a kidney nephron with a short of loop of Henle and didactic/diagrammatic illustration of the vascular supply
- Diagrammatic illustration of an opened kidney renal corpuscle with nephron and light-microscopic transverse sections of the proximal, attenuated and distal segments of a renal tubule
- Diagrammatic/didactic illustration of an opened kidney renal corpuscle

Mounted on base.

23.5 x 25.5 x 19 cm; 1.3 kg

**M-1000301**



### 3B SMART ANATOMY

#### Prostate Model, 1/2 Life-Size

This prostate model provides a cross section of the male genital organs showing a healthy prostate with bladder, urethra, testicle, symphysis and rectum. The narrowing of the urethra due to the change of the prostate is made clear via the 4 cross sectional views on the base of the prostate model.

Mounted on base.

13.5 x 10 x 14 cm; 0.24 kg

**M-1000319**



### 3B SMART ANATOMY

#### Basic Kidney Section, 3 times Life-Size

This colourful and anatomically accurate model depicts a longitudinal section of the human right kidney. All important structures of the human kidney are shown.

No baseboard included.

20 x 12 x 12 cm; 0.3 kg

**M-1000295**

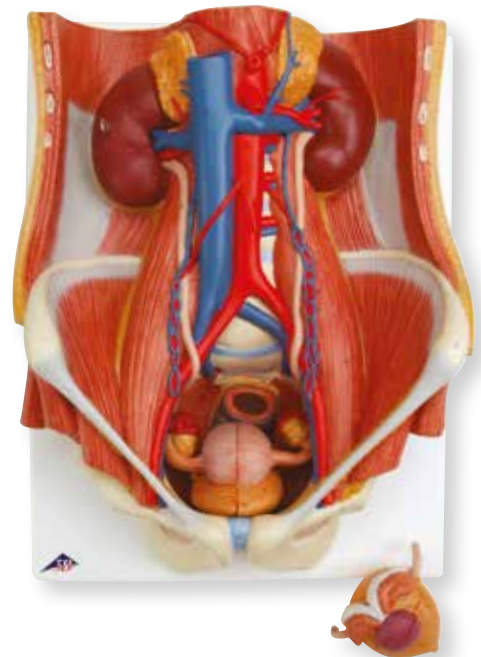

## ➤ NUMBERED PARTS FOR EASY IDENTIFICATION

### 3B SMART ANATOMY

#### Urinary System – Male – 3/4 Life-Size

This urinary system model shows the structures of the retroperitoneal cavity in high detail.

**The right kidney of the model is opened, other details represented are:**

- Inferior vena cava
- Renal veins
- Aorta with its branches
- Iliac vessels
- Ureter
- Urinary bladder
- Prostate
- Adrenal gland
- Rectum
- Musculature

Urinary system model is not delivered on base.

10 x 18 x 26 cm; 1 kg

**M-1008551**



### 3B SMART ANATOMY

#### Dual Sex Urinary System, 6-part

All-in-one model of the human urinary system. One front half kidney is removable; easy to change male insert (bladder and prostate, front and rear half) and female insert (bladder, womb and ovaries, 2 lateral halves).

**For detailed study, the following is shown:**

- Structures of retroperitoneal cavity
- Large and small pelvis with bones and muscles
- Inferior vena cava
- Aorta with its branches including iliac vessels
- Upper urinary tract
- Rectum
- Kidney with adrenal gland

On baseboard.

41 x 31 x 15 cm; 2.3 kg

**M-1000317**

# 3B SMART ANATOMY Sets

## Buy together and save!

Each of our 3B SMART ANATOMY sets contains several models, which complement each other and are available at a great price advantage. Great for classrooms or patient education, each set covers its own different area such as pregnancy, orthopedics, neurology, cardiology and many more. These useful sets will help you learn or explain subjects in a more comprehensive manner. Choose a suitable set for your needs and save up to 15% compared to individual model purchases.

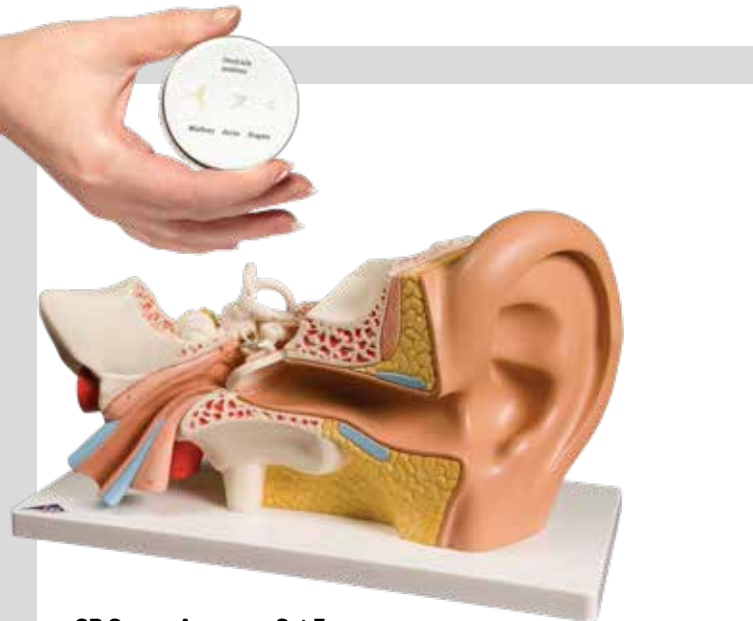

### 3B SMART ANATOMY Set Ear

#### Delivery scope:

- Ear Model, 3-times life-size, 4-part
- Ossicle Model - Life-size

**M-8000844**



### 3B SMART ANATOMY Set Brain and Ventricle

#### Delivery scope:

- Classic Brain, 5-part
- Brain Ventricle

**M-8000842**



### 3B SMART ANATOMY Set Eye

#### Delivery scope:

- Eye, 3-times life-size, 6-part
- 3B MICROanatomy™ Eye

**M-8000843**



### 3B SMART ANATOMY Set Senses

#### Delivery scope:

- Eye Model, 3-times life-size, 6-part
- Ear Model, 3-times life-size, 4-part
- Nose Model with Paranasal Sinuses, 5-part
- Skin Model, 80-times life-size, 3-part

**M-8000847**

15%

DISCOUNT

> SAVE UP TO 15% WITH OUR 3B SMART ANATOMY SETS!

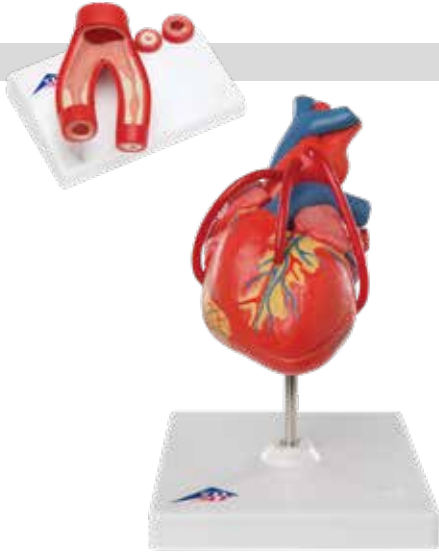

**3B SMART ANATOMY Set Heart**

**Delivery scope:**

- Classic Heart with Bypass, 2-part
- Arteriosclerosis Model, with Cross Section of Artery, 2-part

**M-8000845**



**3B SMART ANATOMY Set Bone Pelvis**

**Delivery scope:**

- Male Pelvis Skeleton
- Female Pelvis Skeleton

**M-8000838**



**3B SMART ANATOMY Set Pregnancy**

**Delivery scope:**

- Stages of Fertilization and of the Embryo, 2-times Magnification
- Pregnancy Pelvis, 3-part

**M-8000848**

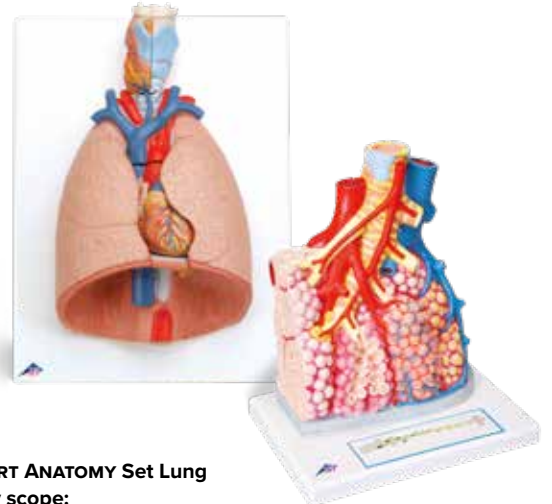

**3B SMART ANATOMY Set Lung**

**Delivery scope:**

- Pulmonary Lobule with Surrounding Blood Vessels
- 3B MICROanatomy™ Pulmonary Lobule with Surrounding Blood Vessels

**M-8000846**

# 15%

DISCOUNT

> SAVE UP TO 15% WITH OUR 3B SMART ANATOMY SETS!

S



### 3B SMART ANATOMY Set

#### Mini Joints

#### Delivery scope:

- Mini Hip Joint with Cross-Section
- Mini Shoulder Joint with Cross-Section
- Mini Knee Joint with Cross-Section
- Mini Elbow Joint with Cross-Section

**M-8000835**

♂



### 3B SMART ANATOMY Set Pelvis

#### Delivery scope:

- Male Pelvis, 2-part
- Female Pelvis, 2-part

**M-8000837**

♀



### 3B SMART ANATOMY Set Muscled Limbs

#### Delivery scope:

- Muscle Leg, 9-part, 3/4 life-size
- Muscle Arm, 6-part, 3/4 life-size

**M-8000841**



### 3B SMART ANATOMY Set Foot Models

#### Delivery scope:

- Hollow Foot (Pes Cavus), life-size
- Normal Foot (Pes Normal), life-size
- Flat Foot (Pes Planus), life-size

**M-8000840**





LEARN ALL ABOUT 3B SMART ANATOMY AT  
[3BSCIENTIFIC.COM/3BSMARTANATOMY](http://3BSCIENTIFIC.COM/3BSMARTANATOMY)



**3B SMART ANATOMY Set**

**Hand and Foot**

**Delivery scope:**

- Hand Skeleton Model with Ligaments and Muscles
- Foot Skeleton Model with Ligaments and Muscles

**M-8000839**



**3B SMART ANATOMY Set Joints Luxury**

**Delivery scope:**

- Deluxe Functional Shoulder Joint Model
- Deluxe Functional Knee Joint Model
- Deluxe Functional Hip Joint Model
- Deluxe Functional Elbow Joint Model

**M-8000834**

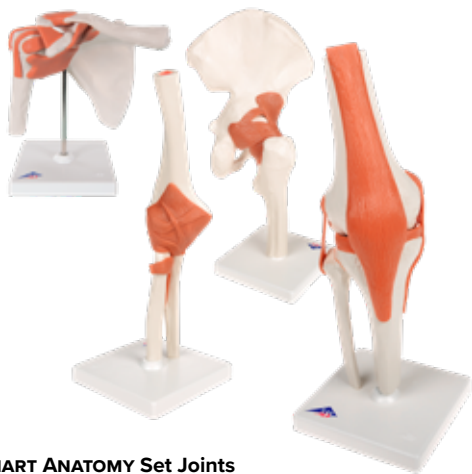

**3B SMART ANATOMY Set Joints**

**Delivery scope:**

- Functional Shoulder Joint Model
- Functional Knee Joint Model
- Functional Hip Joint Model
- Functional Elbow Joint Model

**M-8000832**

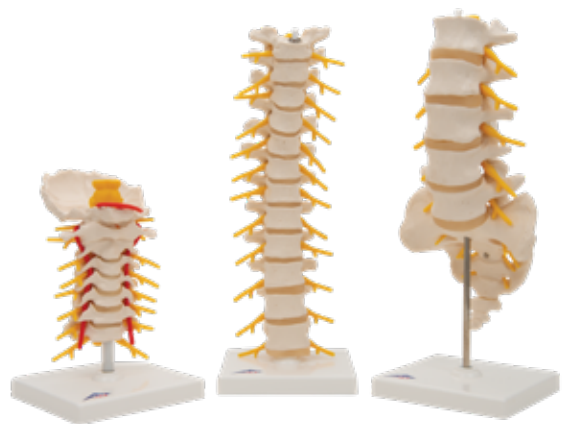

**3B SMART ANATOMY Set Vertebrae**

**Delivery scope:**

- Cervical Spinal Column
- Lumbar Spinal Column
- Thoracic Spinal Column

**M-8000836**



# 15%

DISCOUNT

> SAVE UP TO 15% WITH OUR 3B SMART ANATOMY SETS!



**3B SMART ANATOMY Set Muscle**

**Delivery Scope:**

- 3B MICROanatomy™ Muscle Fiber
- Deluxe Muscle Arm, 6 part, Life Size

**M-8000904**



**3B SMART ANATOMY Set Tongue**

**Delivery Scope:**

- 3B MICROanatomy™ Tongue
- Tongue Model, 2.5 times life size, 4 part

**M-8000905**

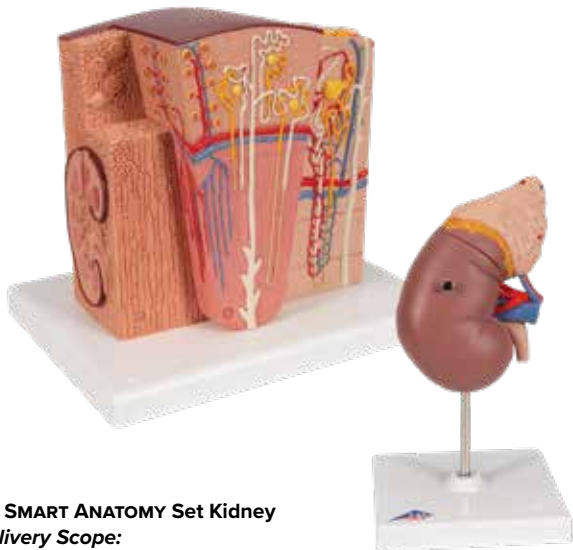

**3B SMART ANATOMY Set Kidney**

**Delivery Scope:**

- 3B MICROanatomy™ Kidney
- Kidney with Adrenal Gland, 2 part

**M-8000906**



**3B SMART ANATOMY Set Digestive**

**Delivery Scope:**

- 3B MICROanatomy™ Digestive
- Digestive System, 2 part

**M-8000907**



PLEASE VISIT [3BSCIENTIFIC.COM](http://3BSCIENTIFIC.COM) FOR FULL DETAILS ABOUT THE MODELS CONTAINED IN THE SETS.

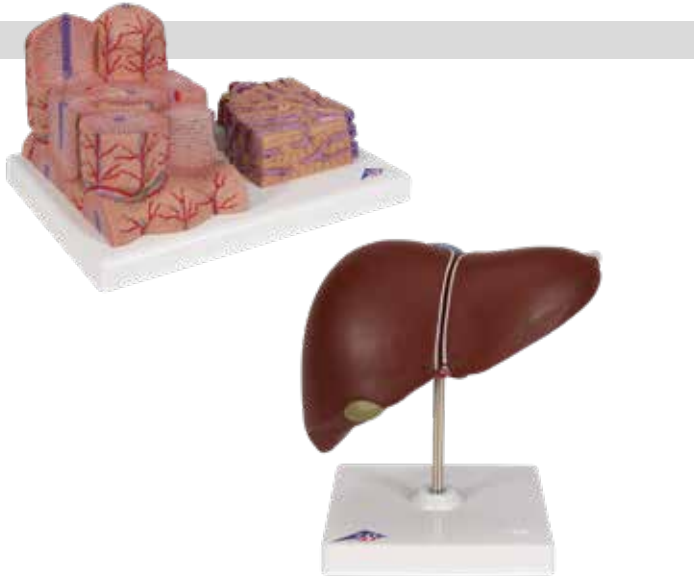

**3B SMART ANATOMY Set Liver**

**Delivery Scope:**

- 3B MICROanatomy™ Liver
- Liver with Gall Bladder

**M-8000908**



**3B SMART ANATOMY Set Anthropology Comparison**

**Delivery Scope:**

- Replica Homo Erectus Pekinensis Skull
- Classic Human Skull Model, 3 part

**M-8000910**



**3B SMART ANATOMY Set Anesthesiology Lab Kit**

**Delivery Scope:**

- Epidural & Spinal Injection Sim
- Lumbar Spinal Column
- Pregnancy Pelvis

**M-8000874**



**3B SMART ANATOMY Set Intro to OB Lab Basic**

**Delivery Scope:**

- Basic Birthing Simulator P90 B
- Basic Pregnancy Series
- Labour Stages Model

**M-8000877**

# 15%

DISCOUNT

> SAVE UP TO 15% WITH OUR 3B SMART ANATOMY SETS!



### 3B SMART ANATOMY Set School

#### **Delivery Scope:**

- Skeleton Model - Stan
- Classic Unisex Torso, 12-part
- Skin Section, 40 times full-size
- Eye, 5 times full-size, 6 part
- Pregnancy Pelvis, 3 part
- Ear Model, 3 times life size, 6 part

**M-8000901**





PLEASE VISIT [3BSCIENTIFIC.COM](http://3BSCIENTIFIC.COM) FOR FULL DETAILS ABOUT THE MODELS CONTAINED IN THE SETS.



### 3B SMART ANATOMY Set Micro Anatomy

#### **Delivery Scope:**

- 3B MICROanatomy™ Bone structure - 80 times enlarged
- 3B MICROanatomy™ Muscle Fiber
- 3B MICROanatomy™ Eye
- 3B MICROanatomy™ Artery and Vein
- 3B MICROanatomy™ Kidney
- 3B MICROanatomy™ Digestive System
- 3B MICROanatomy™ Liver
- 3B MICROanatomy™ Tongue

**M-8000903**



## 3B ORTHObones

**3B Scientific® ORTHObones** are artificial workshop bones and test material specifically developed for teaching orthopedic and surgical procedures, for surgery workshops, and medical engineers. They offer a cost-effective alternative to real human bones for the training of orthopedic techniques in fracture repair like plate osteosynthesis or screw fixation, and for implant training and demonstrations.

- High quality, economical workshop bones
- Bio-mechanically accurate
- Anatomically realistic surfaces
- Ready for imaging procedures without pre-processing
- Short delivery times

# 3B ORTHObones STANDARD



## 3B ORTHObones Standard

- + Economically priced, hands-on workshop bones
- + Realistically simulated characteristics of human bone with defined cortical shell and spongiosa
- + Train surgical manipulations on anatomically correct workshop bones

3B ORTHObones Standard	Item No.
Humerus, right	M-1019604
Humerus, left	M-1019609
Elbow, right	M-1019616
Elbow, left	M-1019617
Radius, right	M-1019605
Radius, left	M-1019610
Ulna, right	M-1019606
Ulna, left	M-1019611
Hand	M-1019618
Hand with Wrist	M-1019619
Femur, right	M-1019601
Femur, left	M-1019607
Knee, left	M-1019621
Knee, right	M-1019622
Tibia, right	M-1019602
Tibia, left	M-1019608
Foot with Hammer Toes	M-1019620
Male Half Pelvis, right	M-1019603
Male Half Pelvis, left	M-1019612
Full Pelvis with Sacrum	M-1019613
Cervical Vertebrae	M-1019614
Thoracic Vertebrae	M-1019615
Lumbar Spine	M-1019700
Lumbar Spine with Sacrum	M-1019701
Femur Teen, right	M-1019702
Paediatric Tibia, right	M-1019703
Paediatric Femur, right	M-1019704
Paediatric Hollow Skull with Support Block	M-1019705

*The multilayered construction simulates the hard cortical and the softer cancellous bone. Mechanical manipulations (i.e. with screws, plates, or implants) can be practiced on these highly realistic workshop bones.*



*The elbow allows for realistic movement while mechanically manipulating the bone.*



*Paediatric Skull*

# 3B ORTHObones PREMIUM



## 3B ORTHObones Premium

- + Biomechanical characteristics of the bones of a young adult (20-30 yrs.)
- + Realistic bone surface structure and weight
- + For advanced training of surgical manipulations
- + Especially suited for high contrast X-ray results without extra preparations

*Latex bands simulate joint movement and leave no trace on the X-ray*

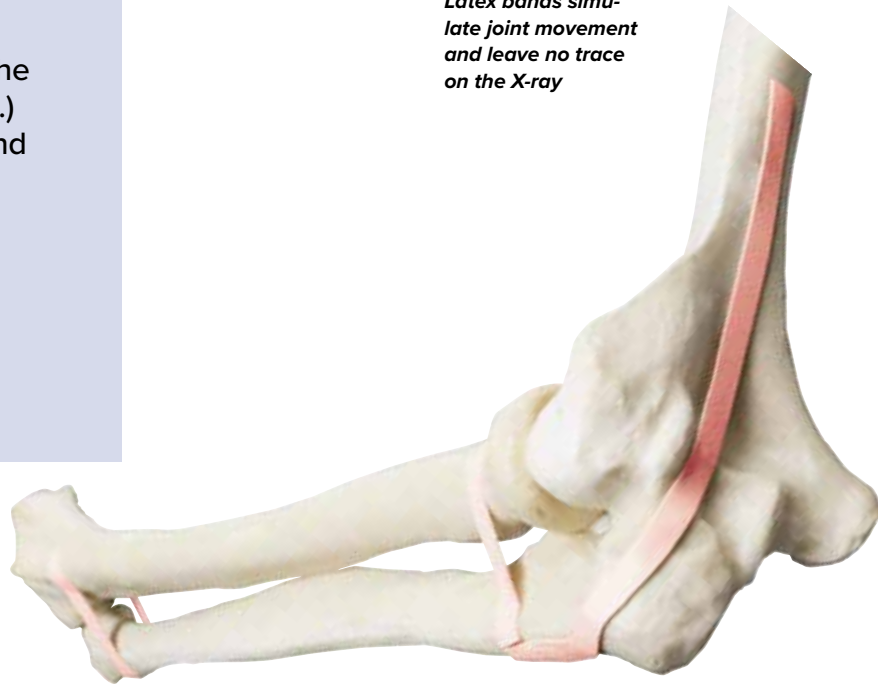

### 3B ORTHObones Premium

### Item No.

Humerus, right	M-1005121
Humerus, left	M-1016670
Radius, right	M-1005122
Radius, left	M-1016671
Ulna, right	M-1005123
Ulna, left	M-1016672
Hand	M-1018336
Hand with Forearm, left	M-1018337
Male Half Pelvis, right	M-1005119
Male Half Pelvis, left	M-1016702
Full Pelvis with Femurs	M-1018342
Right Pelvis with Femur	M-1018344
Left Pelvis with Femur	M-1018343
Full Pelvis with Sacrum	M-1018096
Sacrum	M-1005120
Femur, right	M-1005117
Femur, left	M-1016668
Knee, right	M-1018341
Knee, left	M-1018340
Tibia, right	M-1005118
Tibia, left	M-1016669
Foot with Hammer Toes, Bunions and Heel	M-1018339
Mandible with Teeth	M-1005116
Edentulous Mandible with Gum	M-1018330
Scapula, right	M-1018517
Scapula, left	M-1017629

### 3B ORTHObones Premium Elbow, Ulna, radius, humerus, latex band

Flexibly mounted elbow, comprised of the humerus, ulna, and radius. Thanks to latex bands, the joint is flexible and can be moved. Latex band is glued so it does not interfere with imaging procedures  
**M-1018335**



*High contrast X-ray taken with 3B ORTHObones*



# 3B BIOMECHANICAL TEST BLOCKS

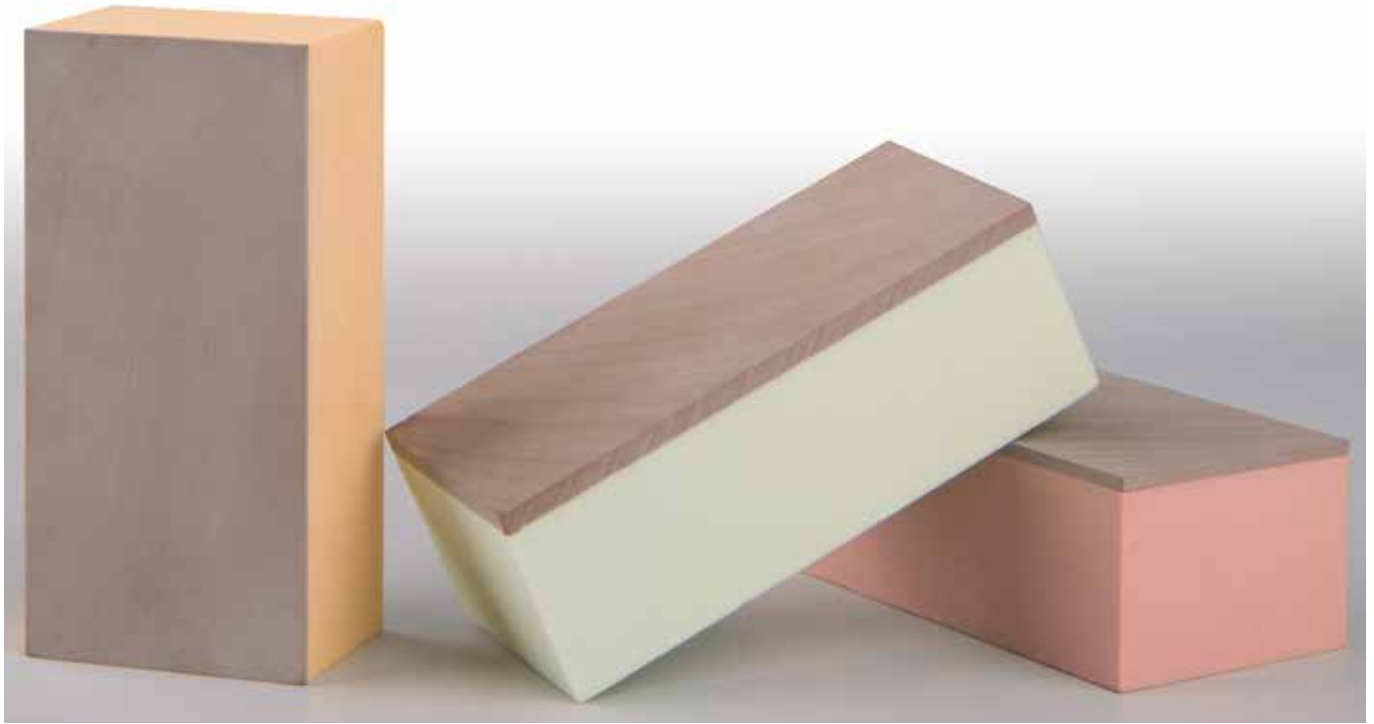

*Test cylinder, shown with sagittal cut*



3B Biomechanical Test Blocks are used to:

- + Test implants and devices
- + Train the evaluation of bone density
- + Simulate different sets of characteristics, i.e. bone density and cortical thickness

3B Biomechanical Test Blocks	Bone density	Cortical Thickness	Item No.
Test Block	10 PCF	CP1	M-1019708
Test Block	10 PCF	CP2	M-1019875
Test Block	10 PCF	CP3	M-1019876
Test Block	15 PCF	CP1	M-1019707
Test Block	15 PCF	CP2	M-1019877
Test Block	15 PCF	CP3	M-1019878
Test Block	20 PCF	CP1	M-1019706
Test Block	20 PCF	CP2	M-1019879
Test Block	20PCF	CP3	M-1019880
Test Block	30 PCF	CP1	M-1019881
Test Block	30 PCF	CP2	M-1019882
Test Block	30 PCF	CP3	M-1019883

#### Bone density: 10 – 30 PCF (Pounds per Cubic Foot)

The solid rigid polyurethane foam is available in 4 different densities: 10, 15, 20 and 30 PCF.

#### Cortical thickness: 1 – 3 mm

The cortical shell is simulated by a dense plate on top of each block. Its density is 30 PCF and three different thicknesses (1, 2 or 3 mm) are available for each foam density option.

#### Dimensions:

CP1: 1 mm cortical thickness: 9.5 x 4.5 x 3.1 cm  
 CP2: 2 mm cortical thickness: 9.5 x 4.5 x 3.2 cm  
 CP3: 3 mm cortical thickness: 9.5 x 4.5 x 3.3 cm





## HEALTH EDUCATION

High quality and functional products to educate about common health risks and diseases. Ideal for educating patients and for student training.



PLEASE SEE PAGE 282 TO FIND OUT MORE ABOUT THE MODEL FOR GYNECOLOGICAL PATIENT EDUCATION M-1013705, FEATURED IN THE IMAGE ABOVE

# WOMEN'S HEALTH



SCAN THE QR CODE ON P. 174 FOR A FREE  
3B SMART ANATOMY DEMO VERSION

## Wearable Breast Self Examination Model

Demonstrate realistic self-examination with this natural casting of a female upper body with C-cup breasts. It can easily be worn, in order to better train and practice breast self-examination.

- Made of 3B Scientific SKINlike™ high-quality silicone for a realistic feel
- Breast examination is possible in both upright and lying positions
- Benign and malignant tumors in different stages of development create an understanding of what to feel for

### Includes:

"Female Breast" chart  
M-1001576, talcum powder, harness and stand.

**Model with Aluminum Carrying Case**      **M-1000342**  
**Model without Case**                              **M-1000343**

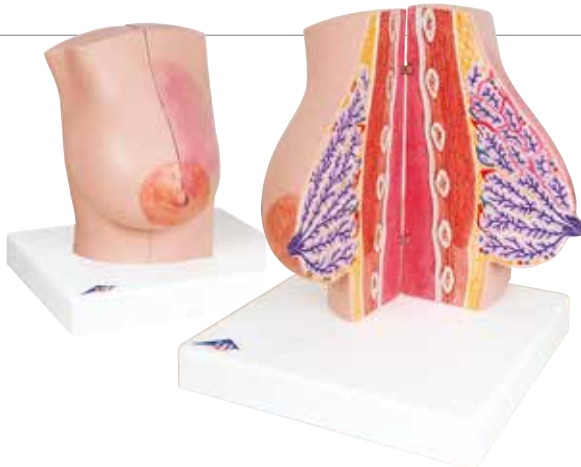

## 3B SMART ANATOMY

### Model of Female Breast

This model is an extremely valuable tool to demonstrate the differences between healthy and unhealthy breast tissue. Shown are a lactating right breast and a non-lactating left breast. Both parts of the model have a sagittal cut showing the tissue of the breast gland as well as the deeper lying anatomical structures such as the muscles, ribs, costal pleura, pulmonary pleura and lungs. A breast gland inflammation (mastitis) is represented on the right breast and various other diseases on the left breast including a benign tumor, two malignant tumors, and two cysts.

The models are fixed together via magnets for easy demonstrations.  
36.5 x 23 x 20 cm; 1.4 kg

**M-1008497**

## Breast Self Examination Model, 3 Single Breasts on Base

Very realistic natural casting of three different female breasts in C and D cups to train and practice breast examination. Supplied with base and talcum powder.

- Made of 3B SKINlike™ high-quality silicone for a realistic feel
- Benign and malignant tumors in different stages of development are featured in two breasts
- The third breast is healthy for comparison

52 x 24.5 x 9.5 cm; 2.3 kg

**M-1000344**



## Single Breast with Benign Tumor

**M-1000345**



# CONTRACEPTIVE EDUCATION



SCAN THE QR CODE ON P. 174 FOR A FREE  
3B SMART ANATOMY DEMO VERSION

## Model for Gynecological Patient Education

Ideal for demonstration purposes and for practicing insertion of female barrier contraceptive devices, including the femidom, cervical cap, vaginal ring, diaphragm and IUD. It is possible to insert various types of pessaries such as ring, bowl or cube which are used in the event of a prolapse or incontinence. Transparent part allows for clear inside view.

26 x 19 x 22 cm; 1.5 kg

**M-1013705**

### Optional Kits:

Contraception Kit **M-1017130**

Pessary Kit **M-1017131**

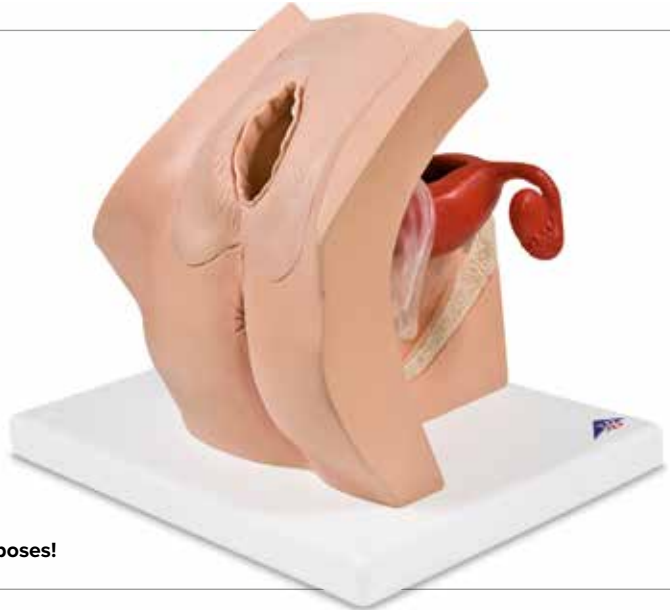

Ideal for demonstration purposes!



PRACTICE I.U.D. AS WELL AS OTHER CONTRACEPTIVE METHODS WITH OUR  
TRAINERS FROM PAGE 98



### I.U.D. Trainer

The hand-held trainer is a suitable aid for understanding correct positioning of I.U.D. (Intrauterine Device) in the uterus. Made of durable plastic, a transparent cover for easy visualization. I.U.D. not included.

6 x 40 x 45 cm

**M-1005766**



### Family Planning Educator

Desktop simulator for training and demonstration of proper introduction and removal of a diaphragm, IUD or sponge contraception devices. This trainer demonstrates both normal and abnormal uterine positions and is ideal for training Bi-manual examination techniques.

#### **The family planning educator is supplied with:**

- One anteverted uterus with clear upper half to illustrate correct position of IUD
- One uterus to illustrate normal anteversion and retroversion
- Cervix attaches to uterus suspended within the pelvic cavity
- Soft plastic stomach cover
- Carrying bag included

25.4 x 25.4 x 25.4 cm; 2.3 kg

**M-1005784**



**3B SMART ANATOMY  
Human Immunodeficiency  
Virus (HIV) Model**

This model has been enlarged millions of times to show the outer lipid membrane with protein structures and the internal nucleus which contains the viral hereditary matter (RNA). Remove the nucleus and you'll find space to place a targeted message regarding measures to take in protecting against HIV. Mounted on base.

18 x 13 x 13 cm; 0.70 kg

**M-1000336**



*Removable parts*

**Female Condom Model**

Represents an anteverted uterus in a simulated pelvic cavity with soft vulva and vagina and a soft plastic stomach cover. A perfect tool to demonstrate the use of a female condom, contraceptive sponge and cervical cap. Supplied with carrying bag.

17.5 x 24 x 14 cm

**M-1005826**



**Condom Training Model**

Demonstrate the proper use of condoms by using this realistic model. Includes 12 condoms, syringe, and artificial semen to simulate ejaculation. Mounted on a stand with suction cups and delivered with carrying bag.

35.5 x 15 x 16.5 cm; 2.30 kg

**M-1005560**

**Optional Equipment:**

**UV-Fluorescent Artificial Semen**

**M-1005561**



**Condom Training Set**

This economy set has 20 styrofoam penis models and provides a means of practicing the correct use of condoms, even in large groups. The reusable models can be fixed to the desk with adhesive tape. Delivered without condoms.

14.5 cm

**M-1005115**



**Condom Training Kit**

Use this model to quickly teach how to use a condom safely. Realistic anatomical structures and firmness. Supplied with 12 lubricated training condoms and a carrying bag.

7.5 x 7.5 x 19.5 cm; 0.35 kg

**Light Skin Tone**

**M-1000340**

**Dark Skin Tone**

**M-1000341**

**Female Pelvis Contraceptive Model**

This model, made from soft BIOlike™ material, provides a cross-section of a female pelvis for demonstrating proper contraceptive insertion.

The side cutout lets viewers see and understand contraceptive placement and removal. Contraceptives not included.

15 x 8 x 9 cm

**M-1017935**



**Training Model for a Female Condom**

This model shows the labia and vagina up to the cervix and is designed to demonstrate and teach the insertion of a female condom. Condoms not included.

12 cm; 0.15 kg

**Light Skin Tone**

**M-1000339**

**Dark Skin Tone**

**M-1000338**



# PREGNANCY & BIRTH



SCAN THE QR CODE ON P. 174 FOR A FREE  
3B SMART ANATOMY DEMO VERSION



## 3B SMART ANATOMY

### Embryonic Development Model in 12 Stages

Represents development of the human germ cells from fertilization until the end of the 2<sup>nd</sup> month of pregnancy in 12 stages. Each stage can be removed from the base individually:

1. Ovum at time of fertilization (conception) with male gamete (sperm)
2. Zygote at 2-cell stage, approx. 30 hours after fertilization
3. Zygote at 4-cell stage, after around 40 – 50 hours
4. Zygote at 8-cell stage, after around 55 hours
5. Morula
6. Blastocyst after around 4 days
7. Blastocyst after around 5 days
8. Blastocyst after around 8-9 days
9. Germ cells at approx. 11<sup>th</sup> day
10. Germ cells at approx. 20<sup>th</sup> day
11. Embryo at around the end of the 1<sup>st</sup> month of pregnancy
12. Embryo at around the end of the 2<sup>nd</sup> month of pregnancy

**M-1001257**



PLEASE REFER TO PAGE 76 TO SEE MORE OB/GYN SKILL TRAINERS



*Easy to understand  
model for patient  
education!*

## 3B SMART ANATOMY

### Stages of Fertilization of the Embryo – 2 times Life-Size

This model illustrates schematically how the ovum matures, how ovulation and fertilization occur and how the fertilized ovum develops to the stage where it embeds itself in the womb wall to begin the growth into an embryo. The various stages are shown in larger-than-life model form in an ovary, fallopian tube and womb. An even more enlarged illustration of each is also printed on the base.

35 x 21 x 20 cm; 1.20 kg

**M-1000320**



**3B SMART ANATOMY**

**Human Embryo Model – 25 times Life-Size**

This human embryo model shows the anatomy of an embryo at approximately 4 weeks old and includes numbered details.

12 x 12 x 23 cm; 0.30 kg

**M-1014207**

*Numbered details!*



*Models are also sold individually!*

**3B SMART ANATOMY**

**Basic Pregnancy Series – 5 Models**

This series consists of five models mounted on one base to show the most important stages of development: 1<sup>st</sup> month, 2<sup>nd</sup> month, 3<sup>rd</sup> month, 5<sup>th</sup> month, 7<sup>th</sup> month. The 5<sup>th</sup> and 7<sup>th</sup> month stages have detachable fetuses.

13 x 41 x 31 cm; 2.10 kg

**M-1018633**



**3B SMART ANATOMY**

**Deluxe Pregnancy Series, 8 Models**

Study human development from the 4<sup>th</sup> week through the 7<sup>th</sup> month. Our most popular series includes eight models to show the complete stages of development. All embryo or fetus models are shown in different typical positions in the uterus and each is mounted separately on an individual stand. The five later stages of development allow the fetus to be removed.

**M-1018627**

**3B SMART ANATOMY**

**Deluxe Pregnancy Series + Embryo Model**

Includes all models above plus the model of an embryo of approx. 4 weeks old, at 25 times life-size.

**M-1018628**

<b>1st Month Embryo</b>	<b>M-1000322</b>
<b>2nd Month Embryo</b>	<b>M-1000323</b>
<b>3rd Month Embryo</b>	<b>M-1000324</b>
<b>4th Month Fetus (Transverse Lie)</b>	<b>M-1018626</b>
<b>5th Month Fetus (Breech Position)</b>	<b>M-1018630</b>
<b>5th Month Fetus (Transverse Lie)</b>	<b>M-1000327</b>
<b>5th Month Twin Fetuses (Normal Position)</b>	<b>M-1000328</b>
<b>7th Month Fetus</b>	<b>M-1000329</b>

**➤ REALISTIC AND HIGH QUALITY**

**3B SMART ANATOMY**

**Pregnancy Pelvis, 3-part**

This anatomy model is a representation of a median section through the female pelvis at 40 weeks pregnant with a removable fetus. Study or demonstrate the normal position of baby before birth with this model plus the human reproductive and urinary systems. A uterus with embryo in 3<sup>rd</sup> month of pregnancy is mounted on base for added detail and comparison. The realistic and high quality female pelvis includes the female genital organs and other important anatomical details.

38 x 25 x 40 cm; 3.80 kg

**M-1000333**

*Median section with removable fetus*

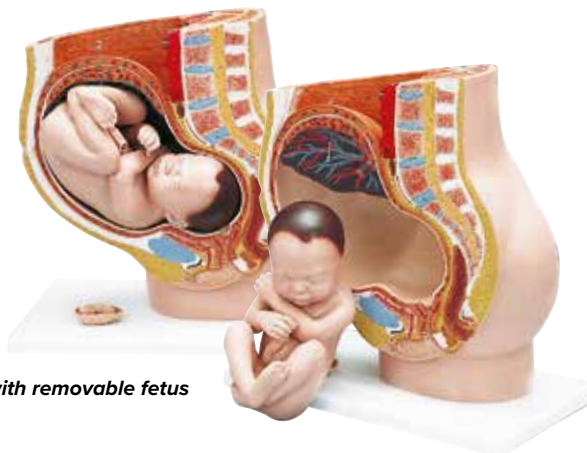



**3B SMART ANATOMY**  
**Childbirth Demonstration Pelvis**

This model demonstrates the progress of a full-term fetal head through the pelvis during birth. The simulator consists of a female pelvic skeleton with a movable symphysis, hip bone, sacrum, coccyx, and 2 lumbar vertebrae. It is articulated to accommodate passage of a fetal skull which is mounted on an omni-positioning flexible gooseneck support. Delivered on baseboard.

33 x 26 x 18 cm; 1.81 kg

**M-1000334**



**3B SMART ANATOMY**  
**Birthing Process, 5 Stages**

Anatomical representation of human birth. 5 stages of the birthing process, mounted individually on bases.

- Fetus in womb, cervix closed; 2-part
- Fetus in womb, cervix open
- Fetus in womb, start of head passage
- Fetus in womb and pelvis, finish of head passage
- Placenta in womb

17 x 28 x 46 cm; 8.62 kg

**M-1001258**

**3B SMART ANATOMY**  
**Labor Stages Model**

At ½ the size of M-1001258, these models are an anatomically detailed representation of human birth. The birth models are supplied on one baseboard, included stages:

- Fetus in womb, cervix closed
- Fetus in womb, cervix open
- Fetus in womb, start of head passage
- Fetus in womb and pelvis, finish of head passage
- Placenta in the womb

40 x 31 x 13 cm; 1.36 kg

**M-1001259**

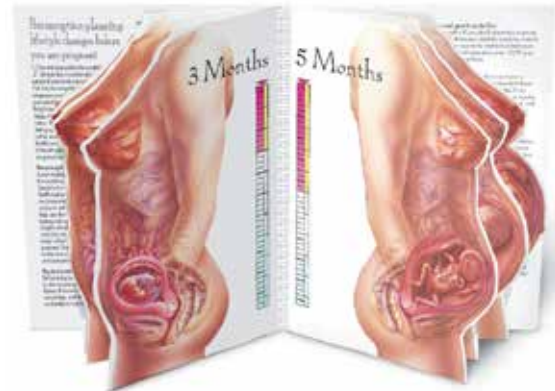

**“With Child” Display**

This life-size, standing childbirth display with overlapping images shows the childbearing cycle from preconception planning through six-weeks postpartum. In English.

45.5 x 61 cm

**M-1018275**



**Childbirth Poster**

The stages of childbirth are discussed as well as the anatomical details of human labor. 51 x 66 cm; printed on premium glossy paper. Different languages are available online.

**M-4006704**

# PARENT EDUCATION

**The original manikin that simulates a baby's varying needs!**



## Ready-or-Not Tot® Manikins

The perfect tool to educate soon-to-be parents and to demonstrate the reality of parenthood. Ready-or-Not Tot® manikins use set programs, and the response can easily be tracked using the template provided.

- Three different tending programs typical of most babies
- Tots cry, coo, and burp in response to appropriate care
- Programs are 48 hours in length and run continuously with 25 – 27 tending occurrences

Comes complete with one set of student keys, one set of teacher keys, reproducible parental consent form/permission slip, reproducible student response sheet, teacher correction template, nappy, and instructions. Anatomically correct newborn-size, representing a baby of a teen mum. 2.49 kg, 51 cm long.

### Light Skin Tone

**Male M-1017931**

**Female M-1017932**

### Dark Skin Tone

**Male M-1018137**

**Female M-1018138**



## Fetus Model

This model simulates an average full-term fetus. The human fetus is made of a soft and durable cloth. The body of the fetus model is flexible to show all presentations and positions possible during birth. The amniotic membrane allows you to show the fetal model inside the sack. The snap-on umbilical cord clearly shows the vein and arteries and a convenient drawstring closes the sack. Both amniotic and chorionic membranes are detailed accurately in two colors.

**Fetus M-1005571**

**Placenta & Umbilical Cord M-1005573**



SEE PAGE 111 FOR MORE PATIENT CARE INFANT MANIKINS

## Baby Care Models

Ideal model for training the main principles of baby care at school and in preparation courses for young parents. It allows dressing, undressing, washing, changing nappies, and many other procedures. Realistic newborn size with movable joints and can be dressed in ordinary baby clothes.

### Dark Skin Tone Baby

**Male M-1005092**

**Female M-1005093**

### Asian Baby

**Male M-1005090**

**Female M-1005091**

### Light Skin Tone Baby

**Male M-1005088**

**Female M-1005089**



# MEN'S HEALTH



SCAN THE QR CODE ON P. 174 FOR A FREE  
3B SMART ANATOMY DEMO VERSION



## Testicle Self-Exam Model

By using 3B Scientific® SKINlike™ high-quality silicone, learning and practicing self-examination of the testicles becomes even more realistic. The scrotum contains two movable testicles, the epididymis, and the spermatic cords for palpation. Two pathological findings can be felt in the left testicle. Supplied with detailed instructions for self-examination and a carrying bag.

9 x 8 x 4 cm; 0.19 kg

**M-1000346**

## Teen BSE/TSE Training Set

This kit contains a teen BSE model and a TSE model to teach teens the importance of the early detection of cancer. Teen BSE model contains lumps in a variety of sizes. TSE model contains two lumps in each testicle. Each model is made of soft, durable BIOlike™ synthetic tissue and comes with slipcover and carrying case.

26 x 23 x 18.5 cm

**Beige Skin Tone M-1017933**

**Brown Skin Tone M-1017934**



## ► REALISTIC REPLICA!

### 3B SMART ANATOMY

#### Male Pelvis Section, 1/2 Life-Size

This cross section of the male genital organs shows all structures in detail. It is a great replica of the anatomy of the male pelvis.

13.5 x 10 x 14 cm; 0.24 kg

**M-1000283**





Four embedded, simulated tumors

### Testicle Self Examination Model

Self-examination of the testicles is just as important as self-examination of the female breasts for early detection of tumors. Providing exceptional realism, this simulator features soft, thin outer skin with delicate underlying structures and four embedded, simulated tumors. Ideal for teaching proper palpation techniques. To maintain the life-like feeling of the skin, baby powder (included) should be applied from time to time.

M-1005640



### Prostate Model

Complete Prostate Model includes six full size prostates. Conditions shown include: normal prostate; normal size prostate with hard nodule below right lobe surface; prostate with enlarged right lobe; enlarged prostate, symmetrical surface, slight median furrow; enlarged prostate, hard nodule below right base surface; enlarged prostate with hard irregular surface and seminal vesicle involvement.

22.2 x 13.3 x 2.5 cm

M-1019544



PLEASE REFER TO PAGE 100 TO SEE MORE PROSTATE TRAINERS

## ➤ NOW AVAILABLE IN DIFFERENT LANGUAGES!

### Why Prostate Exams Can Save Your Life, Easel Display

Hand-painted to simulate the appearance of actual tissue, these five 3D prostate models represent a normal prostate, benign prostatic hyperplasia, early cancer, cancer in a hyperplastic prostate, and late invasive cancer. Comes with protective felt cover.

23 x 30.5 cm

M-1020880

Language Versions	Item No.
English	M-1020880
German	M-1020881
French	M-1020883
Spanish	M-1020885
Italian	M-1020886
Japanese	M-1020884

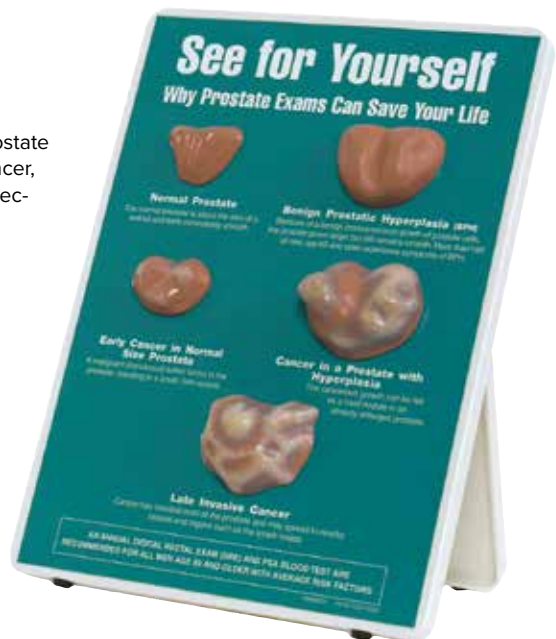

# NUTRITION

## Visualize Your Portion Size Display

For dinner last night, I had a deck of cards, two light bulbs, and a tennis ball! Featuring clever mash-ups of common foods and household objects, this display trains viewers' eyes to recognize portion sizes by relating them to everyday things. For example: a CD/pancake representing 1 oz of grains, a deck of cards/steak representing 3 oz of meat, and a tennis ball/orange representing a medium fruit. Carrying case measures:

ca. 50.8 x 35.6 x 8.9 cm

**M-1020781**



## Fat Chance: A Closer Look at Fast Food Display

A combination of ten tempting food models and corresponding fat-filled test tubes provides a graphic representation of the saturated and unsaturated fat content of common fast foods. Also includes ten food cards with nutritional information, carrying case, and reproducible handout.

**M-1020785**



## Blood Glucose and A1C Levels Model

One half represents healthy blood glucose and A1C levels. In contrast, the model's other half shows a red blood cell containing excess glucose particles which floats through simulated plasma full of glucose particles, representing high A1C and blood glucose levels. Includes informative, bilingual (English/Spanish) tear pad with 100 sheets.

29.21 x 6.35 cm

**M-1020784**



## Vat of Fat

Explaining how calorie intake translates into weight gain is simplified with this graphic and informative display. The plastic jar contains approx. 0.45 kg of goeey simulated fat, which represents the amount of weight a person could gain in one week by consuming an extra 500 calories each day.

12.5 x 16.5 cm

**M-1018309**







## ➤ IMPRESSIVE, HANDS-ON EDUCATIONAL TOOL!

### Complete MyPlate Kit

This kit combines five plates, the display rack, and the food kit for your complete MyPlate educational teaching kit. The 42-piece food kit includes grains, protein, fruit and vegetables Life/form® food replicas. With the included durable plastic plates featuring the USDA healthy eating graphic, you can easily explain the principles of well balanced meals. Your students and patients can fill the plate and learn what to do differently.

**M-1018318**

## ➤ MORE MYPLATE PRODUCTS FOR HEALTHY EATING FEATURING THE USDA HEALTHY EATING GRAPHIC:



### MyPlate Cling Place Mats

These plastic place mats, which are also food clings, are an engaging nutrition teaching tool. Participants can easily create many suggested meals using these guidelines. Set of five place mats with easy cling and peel material.

48.5 x 28 cm

**M-1018317**



### MyPlate Tear Pad with Food Group Tips, Small

The tear pad front shows the MyPlate image while the back gives tips for eating wisely in all five food groups. A simple concise tool to use in nutrition education and send home with each participant. Pad of 50 sheets, each 21.5 x 28 cm.

**M-1018321**



### MyPlate Poster with Key Phrases

Unique MyPlate poster shows 13 key phrases providing clear messages about what to eat and how using the MyPlate technique will make you healthier.

45.72 x 60.96 cm; Laminated.

**M-1018319**



### MyPlate Tear Pads, Large

The tear pad front shows the MyPlate image with appropriate food choices in each spot on the plate, while the back has simple fill-in-the-blank questions to use as a study guide or reminder for those learning good nutrition. Pad of 50 sheets, each 43 x 28 cm, can be used as place mats as well.

**M-1018322**

### Obesity Model

We typically think of fat in terms of how it makes us look on the outside, but this cross-sectional model of the hips cleverly turns the issue inside-out. Pear and Apple shaped bodies in two cross-sections of the hip area. The Pear shape is referred to as "lower body fat". This is mainly composed of subcutaneous fat. The Apple shape is referred to as "intra-abdominal fat". Intra-abdominal fat can be composed of visceral and subcutaneous fat. Illustrating effects from obesity such as compression from visceral fat on the colon, common iliac artery and veins, ureter, small intestine, femoral nerve, etc. The education card depicts an Apple, Pear, and a normal section of the same areas with callouts. Each half of the model is approx. 8.9 x 15.2 x 8.9 cm

**M-1019566**



# HEALTHY LIFESTYLE



## Death of An Artery Easel Display-English

These hand-painted, cross-sectional, 3D models of arteries show patients and students the various stages of plaque build up. The interior size of each vessel diminishes, making it easy to explain a process that can eventually result in death. Comes with protective felt cover.

23 x 30.5 cm  
**M-1018290**



## Why Blood Pressure Checks Can Save Your Life Easel Display-English

Patients and students learn the importance of blood pressure checks when they see these hand-painted, 3D models of arteries and this cross section of the brain. Demonstrates the way high blood pressure can silently lead to heart attacks or strokes. Comes with protective felt cover.

23 x 30.5 cm  
**M-1018289**

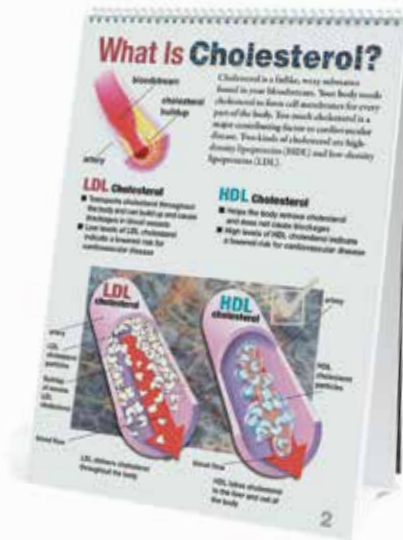

## Cholesterol Flip Chart

Many people do not know what steps they can take to maintain healthy cholesterol levels. This flip chart explains the facts about “good” and “bad” cholesterol and the health risks associated with high cholesterol levels. Features presenter’s notes on reverse panels. Flip chart is 6 panels. 30.5 x 43.5 cm

**M-1018306**



## Occluded Artery Model

The potentially deadly effects of high cholesterol are demonstrated with this persuasive model. The tube represents an artery constricted by plaque, which forms on artery walls when there is excess cholesterol in the blood. When the model is turned over, the blood in the artery slows or stops completely.

7 x 17.5 cm  
**M-1018304**

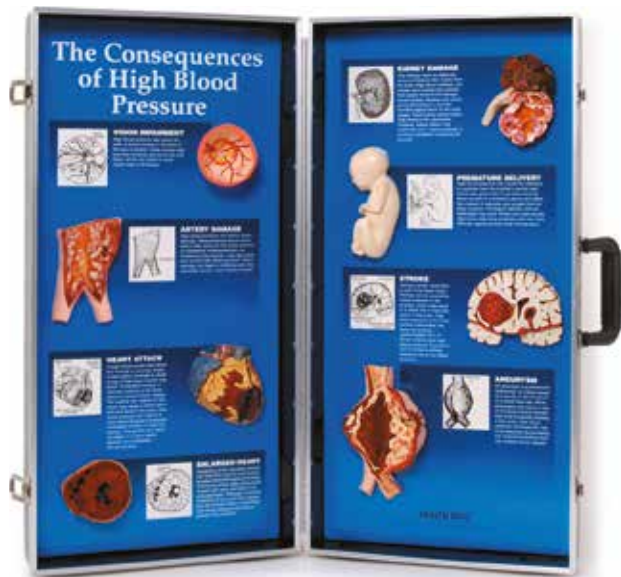

**Consequences of High Blood Pressure, 3D Display**  
 Life-size, 3D, hand-painted models illustrate the various organs that can be affected by high blood pressure. Great for health fairs and health education promotions. Contained in a convenient, sturdy wooden carrying case.  
 71 x 68.5 cm (opened)  
**M-1018277**



**Consequences of An Inactive Lifestyle, 3D Display**  
 This 3D display graphically shows many of the negative health consequences of an inactive lifestyle. Each permanently mounted, hand-painted model has a brief description of the consequences it represents. Display is contained within its own sturdy carrying case.  
 71 x 68.5 cm (opened)  
**M-1018300**

**Benefits of Physical Activity, 3D Display**  
 The four swiveling panels show rewards of an active lifestyle on one side (strong muscles, healthy arteries, healthy joints, and reduced body fat) contrasted with consequences of a sedentary lifestyle on the other side (muscle loss, diseased arteries, osteoarthritis, and increased body fat). Can be mounted on a wall.  
 67.5 x 33 x 13.5 cm  
**M-1018301**



*Can be wall mounted or displayed on a table*

# DIABETES



## Diabetic Injection Practice Kit

Made from realistic BIOlike™ material, these teaching models facilitate technique practice on both an injection skin and a finger stick apparatus. The skin model may be strapped to the user's arm or leg to simulate a needle injection site and the finger stick model may be held by the attached grip for lancet practice. Both can be punctured repeatedly. Comes with powder and carrying case.

Skin model is 15.5 x 11.5 x 4 cm;  
and finger stick model is 2.5 x 11.5 x 2.5 cm.

Beige **M-1018139**



## Diabetic Injection Pad

This pad looks and feels like human skin and is ideal for diabetic instruction and injection practice. May be worn on the body (stomach, thigh, upper arm) to allow patients to inject fluid into the pad to practice giving themselves injections. Pad is thick enough to accept all insulin needles. For safety purposes, the pad has a hard plastic backing to prevent the needle from poking through and into the wearer's skin.

16 x 10.5 x 1 cm

**M-1013057**



## Consequences of Diabetes Display

Hand-painted, 3D models and straightforward text explain the negative effects diabetes can have on the body. A great tool for promoting awareness of this potentially devastating disease. Contained within its own sturdy carrying case. 71.1 x 68.6 cm when opened. English.

**M-1020794**



## Injection Belly

This soft stomach replica is an invaluable tool for teaching patients how to properly insert and rotate the infusion set for insulin pumps, as well as giving self-injections. The trainer has life-like skin with what feels like real stomach tissue underneath. There is a soft plastic backing to keep needles from going through and holes to allow the material to breathe and dry, should you choose to inject water.

25 x 15 x 3 cm

**M-1013056**

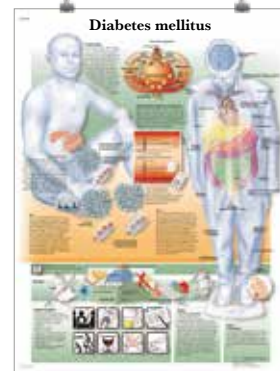

## Diabetes mellitus Poster

51 x 66 cm; printed on premium glossy paper. Different languages are available online.

**M-1001554**

*More charts for patient education also online at [3bscientific.com](http://3bscientific.com)*

### Diabetic Foot Model

This life-size diabetic foot model can be used for both patient education and student training. Made from life-like *BIOlike™* material, the model contains three ulcers in various stages of development as well as the features commonly associated with diabetes. Comes with carrying case and instruction card.

9 x 24 x 10 cm

**M-1017936**



*Consequences of diabetes can be seen on the bottom and top*



### Severe Diabetic Foot Model

This life-size, *BIOlike™* replica complements the original Diabetic Foot Model by showing additional, more severe consequences of diabetes, including an amputated toe, Charcot foot deformity, and severe infection and gangrene. Comes with a carrying case and instruction card.

9.5 x 23 x 11.5 cm

**M-1017937**



PLEASE REFER TO PAGE 115 TO SEE MORE DIABETIC FOOT MODELS

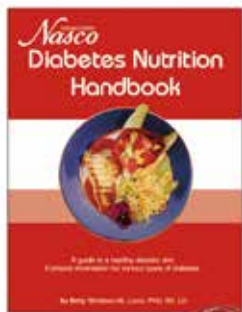

### Diabetes Nutrition Kit

This teaching kit explains the different types of diabetes. The 30-page resource book (English) defines diabetes mellitus and provides menu guides, exercise suggestions, and seven blackline masters.

The 11 Life/form® replicas include: Skim milk, brownie, salmon, French dressing, whole wheat bread, sirloin steak, cheese cubes, bacon, apple, chicken breast, margarine.

**M-1020779**



### Type II Diabetes Set

The Type II Diabetes Set includes miniature brain, eye, heart, kidney, artery, pancreas, neuron, and foot models. Education card illustrates effects associated with Type II Diabetes: stroke, ocular pathology, hypertensive heart disease, hardening of the kidney, hardening of the arteries, insulin resistance, neuropathy, and foot ulcerations. Model display stands 10" tall. Models are reduced size.

22.4 x 15.9 x 24.4 cm

**M-1019573**

# DRUGS & SUBSTANCE ABUSE



## A Year's Worth of Tar

This graphic, sealed exhibit, containing a pack of cigarettes and cigarette butts submerged in goopy tar, represents the amount of carcinogenic liquid a one-pack-a-day smoker puts into his/her lungs over the course of a year.

**M-1005578**



## Goggles for Simulating Drunk Driving

The state of being drunk and how that affects vision and co-ordination can be extremely effectively, realistically and intensely simulated by wearing these goggles. Young people in particular will unavoidably become aware of the danger that comes from drinking and driving. Supplied with case.

**M-1005576**



## Death of a Liver Display

Emphasizing alcohol's role in liver disease, this easel display features cross-sectional, 3D, hand-painted models that represent a normal liver, a liver with hepatitis, and a cirrhotic liver. Comes with protective felt cover.

23 x 30.5 cm

**M-1020786**

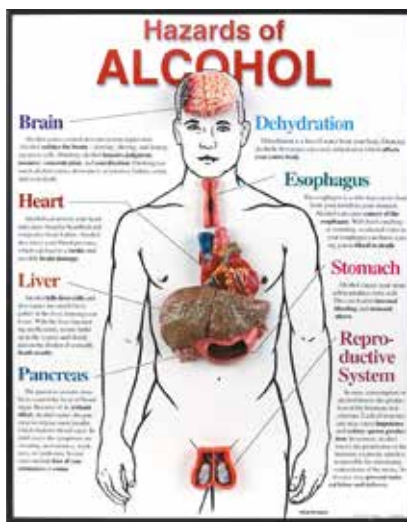

## Hazards of Alcohol 3D Framed Chart

Anatomically accurate, hand-painted, 3D models illustrate the risks associated with alcohol use in this dramatic chart. Alcohol-damaged organs are highlighted and concise, explicit text explains each hazard.

Framed, 52.1 x 66 cm

**M-1020787**

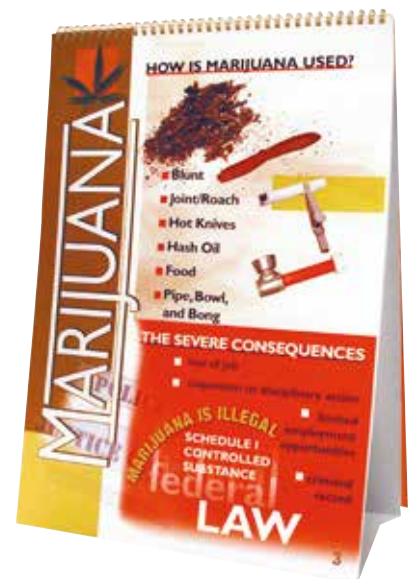

## Marijuana Flip Chart

Describes marijuana, reveals its harmful effects, and lists possible signs of marijuana use. Perfect for teaching that marijuana is not a harmless drug. Flip chart includes presenter's notes on reverse panels. 6 panels.

30.5 x 17.8 cm

**M-1020788**



## ➤ NOW AVAILABLE IN DIFFERENT LANGUAGES!

### Consequences of Alcoholism, 3D Display

Detailed boards with hand-painted models clearly showing the consequences of alcohol abuse on our organs. The brief explanations are ideal for lessons. In carrying case.

Dimensions when opened: approx. 71 x 68 cm

Language Versions	Item No.
English	M-1005582
German	M-1020888
French	M-1020889
Spanish	M-1020891
Italian	M-1020892
Japanese	M-1020890

### Consequences of Drug Abuse, 3D Display

Detailed boards with hand-painted models clearly showing the consequences of drug abuse on the organs. The brief explanations in English are ideal for lessons. In carrying case. Dimensions when opened approx. 71 x 68 cm.

**M-1005583**

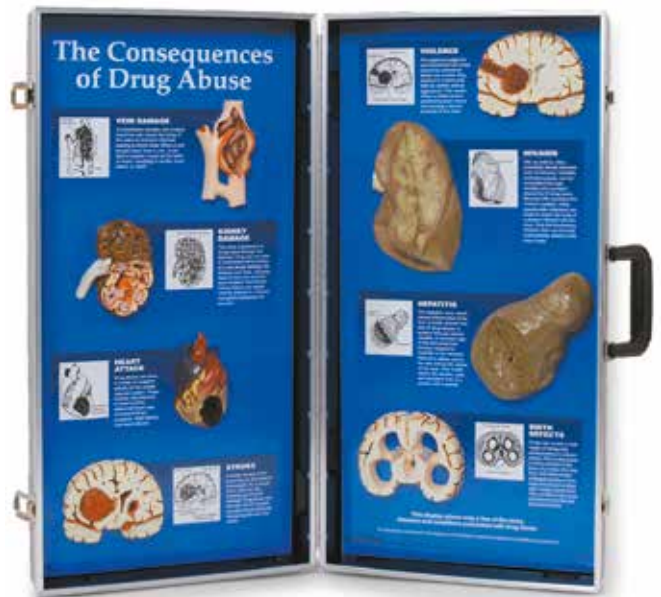

### Lou-Wheeze

Students get a shocking picture of smoking-related lung damage with this interactive display. Lou-Wheeze has two flexible latex lung models. One representing a healthy lung, the other showing the damage done by emphysema and cancer. Students quickly get a sense of the smothering feeling victims of emphysema experience being unable to inhale fresh air because their lungs are overinflated. Comes with bellows pump and instructions.

**M-1020790**



## 3B SCIENTIFIC MEDICAL POSTER

Anatomical poster from 3B Scientific are ideal for teaching human anatomy and for patient education.



PLEASE VISIT [3BSCIENTIFIC.COM](https://www.3bscientific.com) OR SCAN THE QR CODE TO VIEW OUR WIDE RANGE OF POSTER FOR VARIOUS AREAS AND ALL AVAILABLE LANGUAGES



FOR EVERYONE THE RIGHT CHOICE – LOW-PRICED PAPER VERSIONS OR VALUABLE LAMINATED LUXURY VERSIONS IN VARIOUS LANGUAGES

VR1118/4006652/1001470

# The Human Musculature

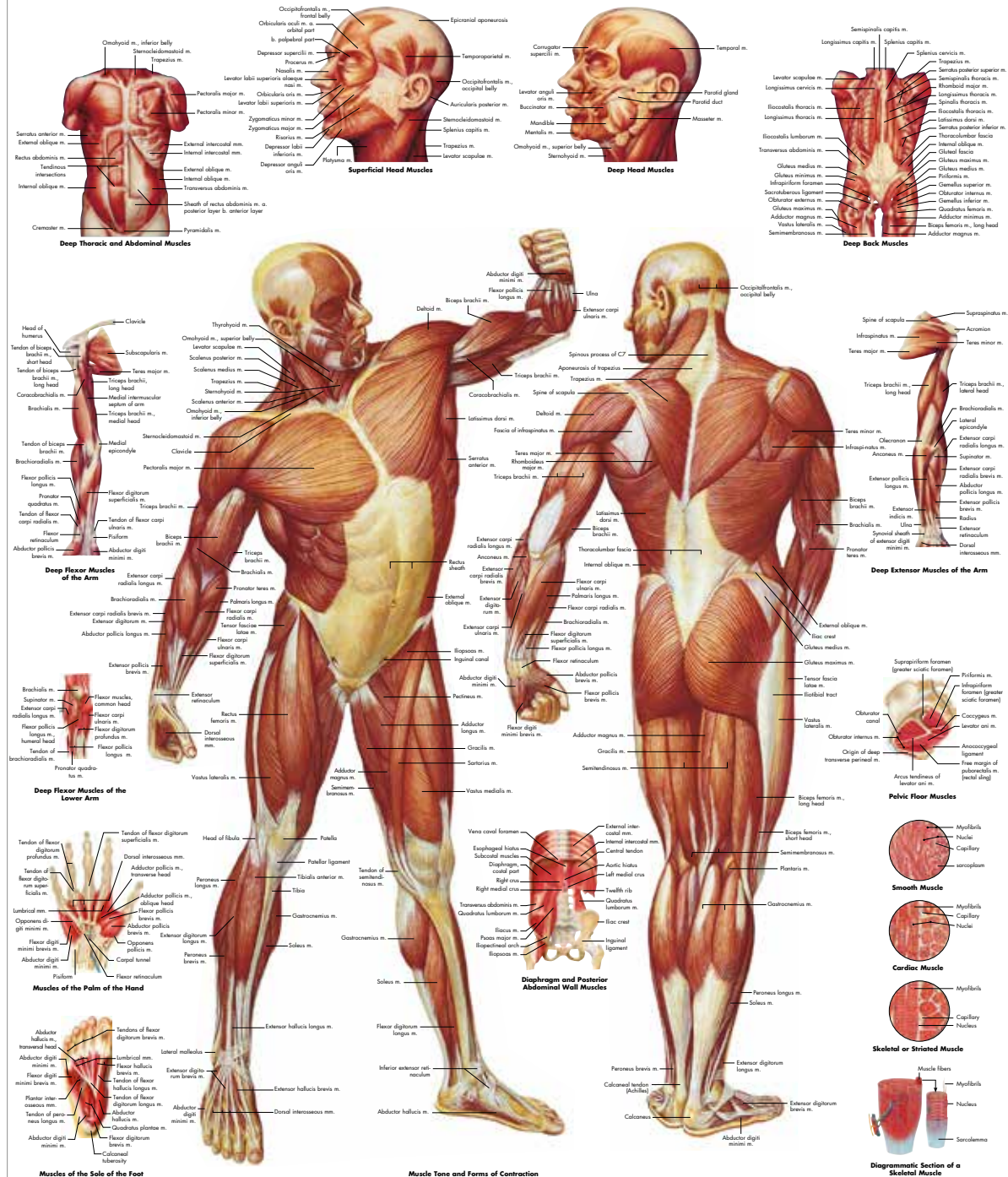

**Muscle Tone and Forms of Contraction**

Muscles receive nerve impulses continuously, even at rest. These impulses create a certain amount of tension in the muscle, called muscle tone. If the nerve innervating a muscle is severed, the muscle loses its tone and displays a flaccid paralysis. When nerve impulses are interrupted, the muscle shortens and develops more tension. If the muscle is able to shorten unimpeded, tension remains constant and motion is produced. If a called isometric contraction. If the muscle's attachment to points of origin and insertion prevent or reduce its length, muscle tension increases and no motion is produced. This is called isometric contraction. Muscles contract tonically in order to maintain body posture, for example, an upright position of the spinal column is thereby ensured.



The Human Musculature  
Laminated M-1001470  
Paper Version M-4006652

© 3B Scientific GmbH  
www.3bscientific.com  
Hamburg, Germany, 1998 - 2003  
Design and text: Arno Grottel, Wilfried Henig  
Illustrations: Holger Vetterlow

## Medical Poster

You will always find the main points on topics like Skeleton and Muscles of the Human Body, Eyes, Ears, Heart, Lungs, Nerves and Diseases such as Diabetes Mellitus, Hepatitis, Cancer, Allergies and lots more.

### Poster Guide

All posters are clearly illustrated and competently described. Printed on high quality paper with optional lamination. Format 50 x 67 cm. Available in multiple languages.

	Laminated	Paper
<b>Bones</b>		
Human Skeleton	M-1001468	M-4006651
Shoulder and Elbow	M-1001482	M-4006658
Hand and Wrist	M-1001484	M-4006659
Pelvis and Hip	M-1001486	M-4006660
Foot and Ankle	M-1001490	M-4006662
<b>Muscle</b>		
Human Musculature	M-1001470	M-4006652
<b>Pathologies</b>		
Osteoporosis	M-1001472	M-4006653
Arthritis	M-1001474	M-4006654
Sports Injuries	M-1001494	M-4006664
Diseases of the Eye	M-1001498	M-4006666
Rhinitis and Sinusitis	M-1001504	M-4006669
Diseases of the Middle Ear	M-1001506	M-4006670
Respiratory Tract Infections	M-1001508	M-4006671
Skin Cancer	M-1001514	M-4006674
Alcohol Dependence	M-1001620	M-4006727
Nicotine Dependence	M-1001622	M-4006728
Allergies	M-1001596	M-4006715
Decubitus Ulcers	M-1001606	M-4006720
Flu (Influenza)	M-1001608	M-4006721
HIV and AIDS	M-1001610	M-4006722
Pneumonia	M-1001518	M-4006676
Common Cardiac Disorders	M-1001526	M-4006680
Varicose Veins	M-1001534	M-4006684
Diseases of the Digestive System	M-1001548	M-4006691
Colon Cancer	M-1001550	M-4006692
Hepatitis	M-1001552	M-4006693
Diabetes	M-1001554	M-4006694
Cholesterol	M-1001558	M-4006696
Stroke	M-1001590	M-4006712
Alzheimer's Disease	M-1001592	M-4006713
<b>Organs</b>		
Human Eye	M-1001496	M-4006665
Human Ear	M-1001500	M-4006667

	Laminated	Paper
The Larynx	M-1001502	M-4006668
The Skin	M-1001512	M-4006673
Lymphatic System	M-1001540	not available
The Liver	M-1001544	M-4006689
The Urinary Tract	M-1001562	M-4006698
Kidney	M-1001564	M-4006699
The Prostate Gland	M-1001566	M-4006700
Human Brain	M-1001584	M-4006709
<b>Pregnancy &amp; Childbirth</b>		
Pregnancy	M-1001572	M-4006703
Childbirth	M-1001574	M-4006704
Breastfeeding	M-1001578	M-4006706
Birth Control	M-1001580	M-4006707
<b>Gynaecology</b>		
The Female Genital Organs	M-1001568	M-4006701
The Female Breast	M-1001576	M-4006705
<b>Stomach</b>		
The Gastrointestinal System	M-1001542	M-4006688
The Stomach	M-1001546	M-4006690
<b>Cell Genetics</b>		
Human Metabolic Pathways	M-1001556	M-4006695
<b>Blood Vessel &amp; Nervous System</b>		
The Blood	M-1001538	M-4006686
The Vegetative Nervous System	M-1001582	M-4006708
The Nervous System	M-1001586	M-4006710
Spinal Nerves	M-1001588	M-4006711
<b>Acupuncture</b>		
Foot Reflex Zone Massage	M-1001624	M-4006729
Ear Acupuncture	M-1001628	M-4006731
Body Acupuncture	M-1001626	M-4006730
<b>Dental</b>		
The Teeth	M-1001510	M-4006672
<b>CPR</b>		
Basic Life Support	M-1001616	M-4006725
<b>Lungs</b>		
The Respiratory System	M-1001516	M-4006675



PLEASE VISIT [3BSCIENTIFIC.COM](http://3BSCIENTIFIC.COM) TO SEE ALL LANGUAGE VERSIONS



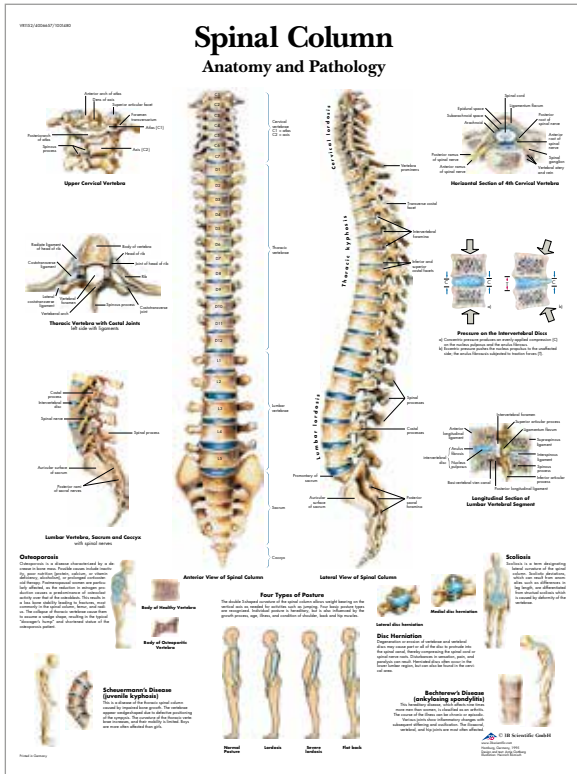

**Spinal Column – Anatomy & Pathology**  
Laminated M-1001480  
Paper Version M-4006657

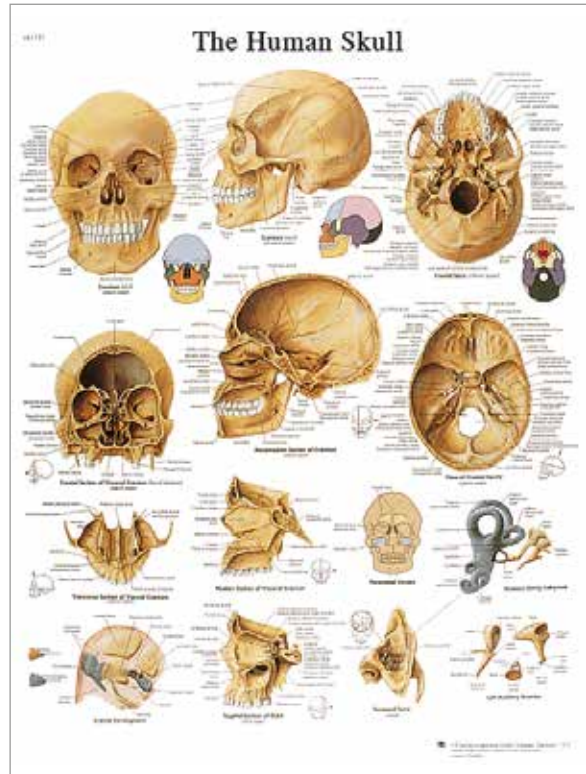

**The Human Skull**  
Laminated M-1001478  
Paper Version M-4006656

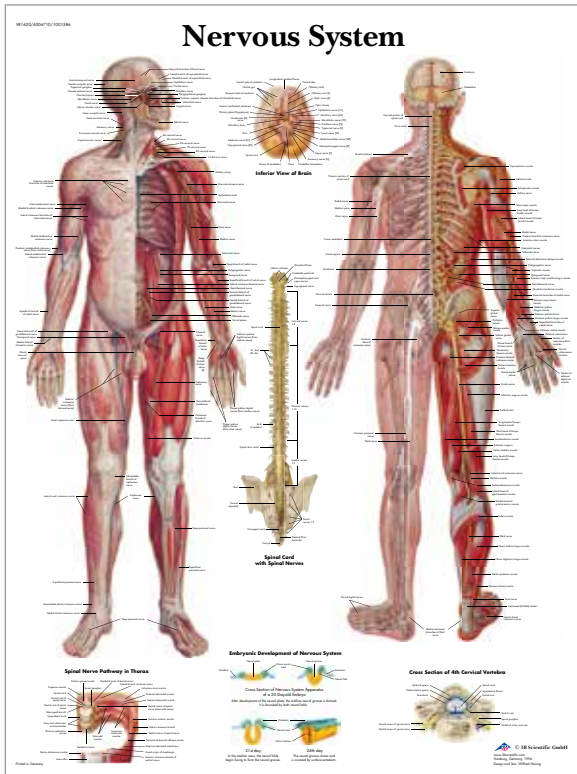

**Nervous System**  
Laminated M-1001586  
Paper Version M-4006710

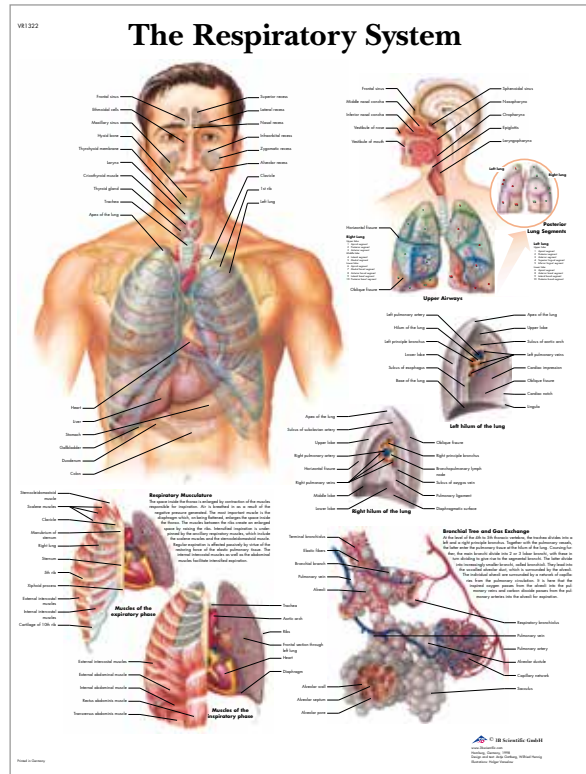

**The Respiratory System**  
Laminated M-1001516  
Paper Version M-4006675

# 3B SCIENTIFIC® PRODUCT RANGE



## MEDICAL SIMULATION

Simulators and skills trainers enable students to develop or enhance their knowledge, skills, or to analyze and respond to realistic situations in a simulated environment, and to gain competence and confidence. You will find simulators and skills trainers for all your training needs manufactured to meet all your standards at [3bscientific.com](http://3bscientific.com).

## MEDICAL EDUCATION

Anatomical models are an essential teaching tool in medical education both for students and patients. Cast from actual specimens, 3B Scientific's anatomy models are professionally manufactured to meet medical quality standards. All models are hand-painted, made from medical quality phthalate free plastics and lead free paints, and are compliant to the EU REACH regulation. The 3B Scientific brand name represents quality materials, superior craftsmanship and a 3-year quality guarantee.

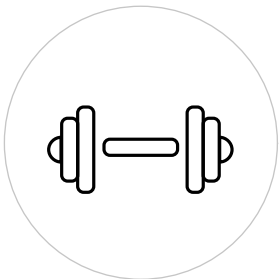

## HEALTHCARE AND HEALTH EDUCATION

For more than 7 decades 3B Scientific has focused on providing life-like learning experiences and expanded into patient education for practitioners. In addition to medical simulators and anatomical models for medical education the company provides supplies and devices for healthcare practitioners such as physiotherapists, chiropractors, natural-health professionals, and acupuncturists. Finding the right products is now faster than it has ever been. Visit [3bscientific.com](http://3bscientific.com) to see the full range of therapy and fitness equipment and accessories.

## ACUPUNCTURE

Traditional Chinese Medicine (TCM) treats the body as a whole. Today, the integration of eastern and western medicine is growing at a fast pace and clinics and hospitals are providing acupuncture treatments. The quality of the tools and needles used during the treatments is of highest importance for the comfort of the patients. 3B Scientific offers high quality acupuncture needles and tools at competitive prices.

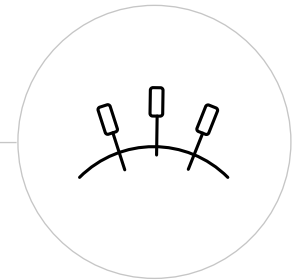

## BIOLOGY

The 3B Scientific group has a rich history in this area dating back to 1819 when Calderoni – now Hungary 3B Scientific, was one of the forerunners in natural science education. Engaging Biology classes are the most effective way to create a long-lasting learning experience. 3B Scientific models are perfect tools for fascinating, hands-on education, all cast from actual specimens and made of highest quality material.

## PHYSICS

Physics teaching success depends on reaching students with practical, hands-on, inquiry based education. 3B Scientific products support teachers worldwide in mastering this challenge with engaging, exciting products and experiments.

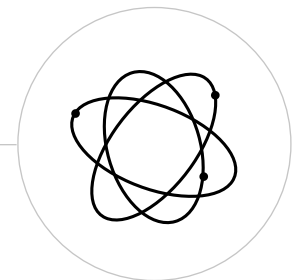



# CONNECT WITH US!

VISIT YOUR LOCAL 3B SCIENTIFIC REPRESENTATIVE ONLINE!  
Order online, save time and find full product information and more!

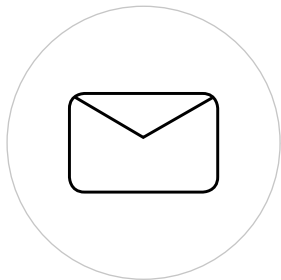
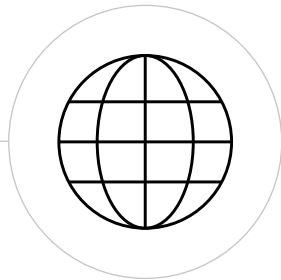

SEND AN E-MAIL TO YOUR LOCAL 3B SCIENTIFIC REPRESENTATIVE!

CALL YOUR LOCAL 3B SCIENTIFIC REPRESENTATIVE!





# 3B Scientific

A worldwide group of companies

**Distribútor pre SR:**

**KVANT spol. s r.o.**

FMFI UK, Mlynská Dolina

842 48 Bratislava

web: **www.skola.sk**

email: **obchod@skola.sk**

tel.: **0918 533 645**

## WEARABLE SIMULATION THE BIONIC HYBRID AUSCULTATION SIMULATOR

When worn by the standardized patient, the suit simulates physiological conditions to test diagnostic and procedural skills. It is controlled wirelessly with easy to use software and responds in real time to diagnosis and treatment with direct feedback. Features 5-wire EKG connections, pulse points, optional blood pressure cuff accessory, as well as auscultation capabilities. Instructors can easily adjust and adapt the suit scenarios to fit many conditions wirelessly by using the SimScope™ Wifi. SimScope™ Wifi and tablet included with system. Reusable and washable (30°C), available in different sizes.

➤ MORE ON PAGE 150

